

A T

MAY 1988
\$2.95 US
\$3.95 CANADA, FOREIGN

...number = in
...ea code, p
TWO PASCALS FOR THE IIGs

The #1 Apple II Magazine



NETWORK



NETWORK ROUNDUP

AppleTalk
Corvus Omninet
Other Networks
Software Issues
...and More

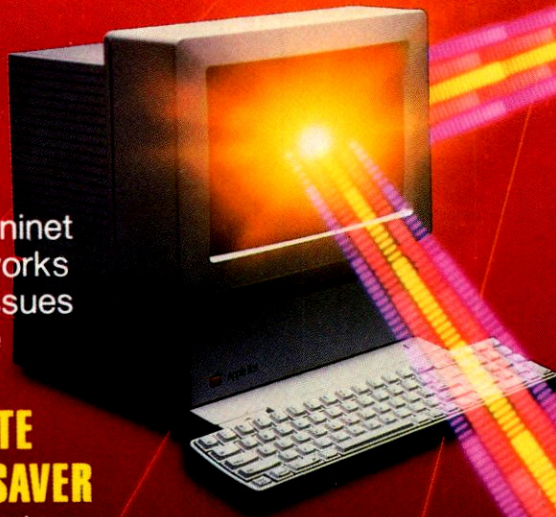

APPLETALK COMES TO THE APPLE II

CHECKMATE MEMORYSAVER

Fast Access to
Lots of GS Memory

APPLEWORKS IN EDUCATION

A Resource Guide
for Educators
and Students



*****3-DIGIT 371
#GAS0116S091 8#680488 8H

DR KENNETH BUCHHOLZ
WWW.APPLE2ONLINE.COM



71486 02401

DMG.

GEOS™ for 128K, 80 column Apple II computers.

- True graphical operating system.
- Data file compatibility with GEOS applications for other systems, such as Commodore C64 and C128.
- Dialogue boxes.
- Proportional fonts in 5 styles.
- Supports variety of printer interface cards, input devices (such as mouse or

joystick), hardware clock cards, printers and disk drives.

- Keyboard shortcuts.

1. deskTop™

The graphic interface from which you operate the powerful GEOS system.

- Graphic representation of disk catalog & GEOS operations.
- Supports ProDOS files (list, copy, run, etc.).
- Supports hierarchical file structure (directories): Create, copy and move directories.
- View files in either icon or text mode.
- Automatically sorts files alphabetically or by size, type or date.
- Open, copy or delete files in seconds: Copy or delete entire directories in one step. Select several files at once to perform multi-file operations.
- Formats, verifies and erases disks.
- Simultaneously supports combinations of up to 4 disk devices: 5-1/4" drives, 3-1/2" drives, hard drives and RAM drives.
- Applications and desk accessories stored in the "system folder" are listed in drop down menus, and can be run from any directory.
- Double-clicking data file automatically searches for parent application on each disk.

2. geoWrite 2.1™

All the GEOS-compatible tools that a writer needs to make professional documents.

- "What You See Is What You Get" orientation.
- Point and click text selection: Perform moves, copies, deletions and changes on blocks of text.
 - Supports LaserWriter through geoLaser.
 - Multiple proportional fonts in a variety of point sizes same bit images as the Mac.
 - Variable styles (**bold**, *italic*, outline, underline).
 - Cut, copy and paste text or graphics from other programs, like geoPaint.
- Left, right and full justification.
- Adjustable margins from 0.25" to 8.25"

- Single, 1½ and double spacing.
- Search and replace text.
- Text and decimal tabs.
- Headers and footers, auto page numbering, date stamping.
- Create page breaks.
- Keyboard shortcuts.
- Set initial page number.

3. geoSpell™

- Find and correct misspelled words in any geoWrite document.
- Misspelled words are displayed in context in the document window.
- Displays words in dictionary closest to misspelled word and prompts user for action.
- Over 38,000 word geoDictionary.
- Create personal dictionaries for specialized vocabularies.

- Automatically scans geoDictionary and personal dictionary.
- Single or all occurrence replace options.
- Edit and update personal dictionaries at any time.
- Ability to scan the geoDictionary and the personal dictionary independent of the geoWrite document.

4. Text Grabber™

- Convert existing word processing documents to the GEOS environment from other word processing programs, such as AppleWorks, WordPerfect and MultiScribe.
- Reformat new files with ease.
- Files from other word processors are ported with formatting commands intact.
- After converting files into geoWrite documents, you can change fonts, formats, styles and paste in graphics.

5. geoMerge™

- Create personalized form letters, merge names and addresses or conditionally include whole paragraphs.
- Print merged documents directly to the printer or create geoWrite files.
- Merge data can be entered manually, typed into a geoWrite file, or be created by other GEOS applications, such as geoEx and geoFile.

6. geoPaint™

- Create charts, diagrams or full page images up to 8½" x 11"
- Zoom in for detail work.
- Cut, copy and paste images to and from other GEOS applications/documents.
- Preview entire page.
- Keyboard shortcuts.
- 14 separate graphic tools:
 - Scroll to an adjacent area in your picture, or use window tool. Select any area of the page and: Move, Copy, Clear, Invert, Rotate, Mirror (horizontally and vertically). Pattern Fill: 32 distinctive painting patterns. Stop pattern fill at any time. Spray Paint: Gradually paints the current pattern for shading effects. Ruler: Measure in inches or pixels. Line: Create separate or connected lines. Brush: 32 different brushes to choose from, each brush paints in the current pattern. Pencil Eraser: Erase a small section or the whole screen. Text: Display text in a variety of GEOS fonts (bold, underline, italics, outline, inverted). Edit text before pasting into picture. Rectangles: Draw rectangles open or filled with the current pattern. Ability to constrain rectangle to a square. Ellipses: Draw ellipses open or filled with the current pattern. Ability to constrain ellipse to a circle. Undo: Undo the last command.

7. Desk Accessories

- Available from within any application.
- Notepad.

- Calculator.
- Alarm Clock.
- Photo Manager (scrapbook for collecting pictures).
- Text Manager (scrapbook for collecting text).

8. geoLaser™

- Produce near-typeset quality output on an Apple LaserWriter.
- Create multi-column and windowed pages with the overlay print option.

To order call 1-800-443-0100 ext. 432

GEOS \$129.95

(California residents add 7% sales tax.)

\$2.50 US/\$5.50 Foreign for shipping and handling. Allow six weeks for delivery.

*GEOS requires 128K and 80 column card.

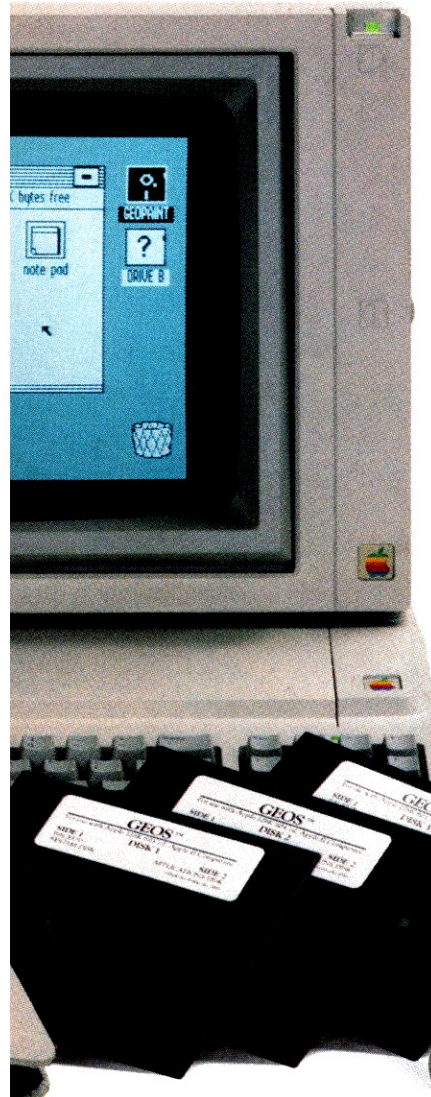

With GEOS, any Apple IIe, IIc* or compatible becomes a menu/icon driven powerhouse.

and from each other, so that you can manage everything with one integrated system.

So the next time someone asks you which Apple is the one that's famous for its mouse, icons and desktop publishing, don't stammer. Don't hesitate. Don't even blink.

Just load up your Apple II with GEOS, look them straight in the eye, and say, "Mine."

**berkeley
ftworks**

are working with Berkeley.

For everyone who ever wished their Apple II could turn into a Mac-Intosh, we've got some great news.

It's called GEOS. And it turns any Apple IIe, IIc or compatible into a ProDOS-compatible, mouse-driven, icon-loaded, graphical operating powerhouse that packs all this power into one package: A desktop file manager, four applications, three utility programs, five desk accessories, six fonts and an interrupt management card.

GEOS (Graphic Environment Operating System) opens your Apple to an infinite number of graphically-oriented applications. Like writing, painting, desktop publishing, calculating—in fact, GEOS can do just about anything a Mac can do.

The kernel at the core of your Apple.

What changes your Apple at its very core is the herculean GEOS kernel, which supports printer drivers, input drivers and proportionally-spaced fonts. It also supports pull-down-menus. Icons. Dialogue boxes. Cutting and pasting data within and between applications. And switching directly from one application to another.

It supports peripherals, desk accessories—in short, it supports just about everything you'd ever want to do with a computer.

And all this without missing a beat. That's because the interrupt management card makes sure you never miss a key stroke, no matter how fast your fingers fly.

Everything's controlled from the deskTop.

The GEOS deskTop lets you control and manipulate virtually everything from icons to RAM disks. And the way you control everything is very simple:

Point and click.

When GEOS offers you options, you just point to your answers and click your mouse or joystick.

You want to copy a file? Point and click.

You want to print a file? Point and click.

You want to delete a file? Point and click, and drop it in the waste basket.

The deskTop also keeps you organized. Art, documents—everything is stored and filed on the GEOS deskTop. View files as icons or text. Even sort files by type, name, date or size.

And you can keep yourself organized on up to four different disk devices: 5¼", 3½", hard disks and RAM disks. All at the same time or in any combination.

A few bits off the old Mac.

But if you really want to get Mac-like, open up geoWrite 2.1. The "What You See Is What You Get" word processor that lets you center, justify, search and replace text. You can move blocks of copy. Cut and paste. Use headers and footers and even display your text in fonts of different styles and sizes—**bold**, *italic*, plain, outline or underline—right on the screen. And since they're the exact same bit image fonts as the Mac, the documents off a LaserWriter or ImageWriter are indistinguishable from a Mac's.

If your spelling isn't up to par, fear not: geoSpell scans your script and fixes your faux pas in context right before your eyes. And for all the documents you've already written on another word processor, there's Text Grabber, which converts your non-GEOS files into geoWrite format.

For those form letters that need to address themselves to different people, there's geoMerge, the text manager that supports everything from simple mail features to conditional paragraphs.

Put that all together with geoLaser's PostScript support, and all of a sudden the documents on that little Apple of yours are looking

a whole lot juicier.

Not only that, but with geoPaint, you become a Michelangelo with a mouse, sketching and painting on an 8½" × 11" page with 32 brushes, 32 patterns and all kinds of textures.

You can invert, mirror and rotate images. Zoom in to edit pixel by pixel, or preview the entire page. Insert pictures into your geoWrite documents. Or save them in your GEOS Photo Album for use later.

There's even a set of pop-up desk accessories for that helping hand in any application. There's an alarm clock that

WORD

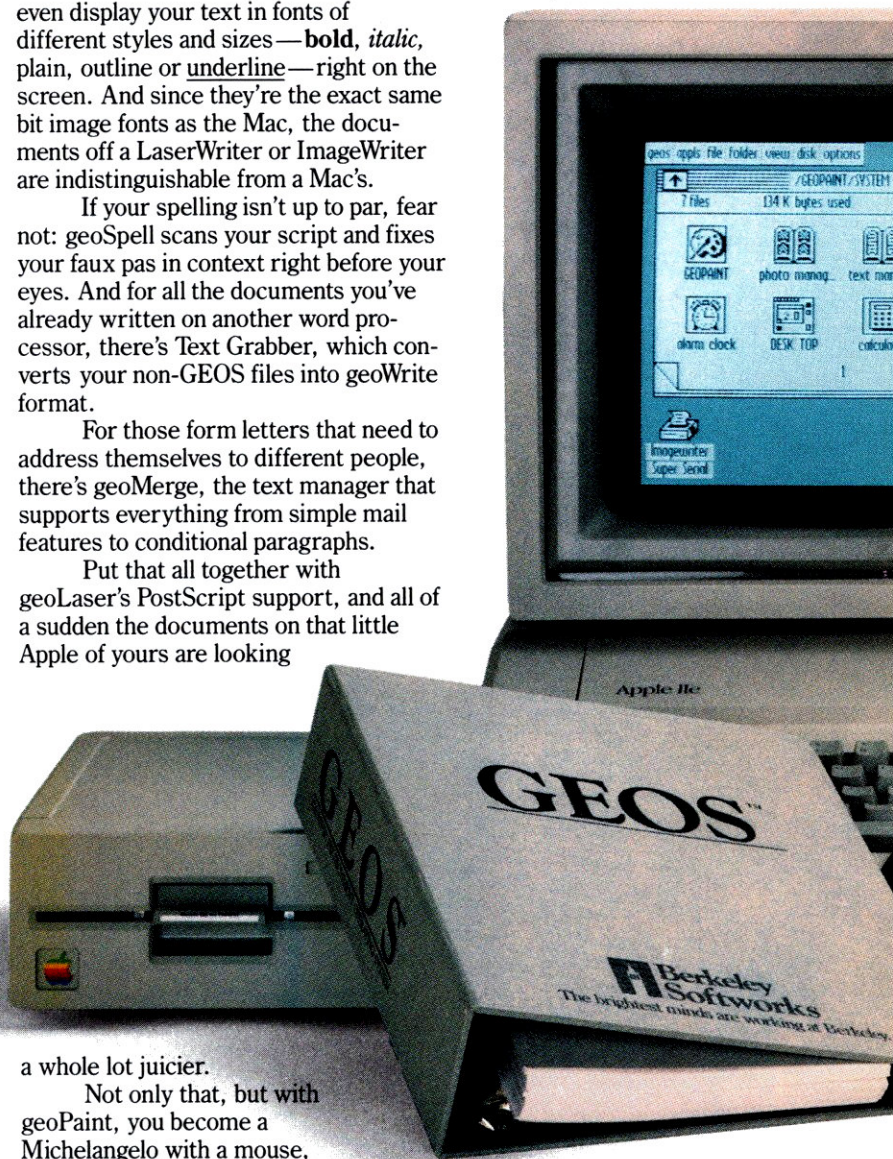

keeps you punctual. A notepad that keeps your memos. And a calculator that keeps your accountant honest.

Polish up your Apple with GEOS.

There are even more GEOS applications on the way. Spreadsheets, databases, desktop publishers—you name it. All of them importing and exporting to



The brightest minds

**NAME AN
APPLE THAT'S
FAMOUS FOR
ITS MOUSE,
ICONS, GRAPHIC
APPLICATIONS
AND DESKTOP
PUBLISHING.**

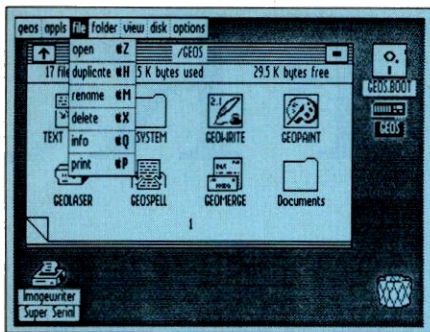

1. Icon and menu file managing.

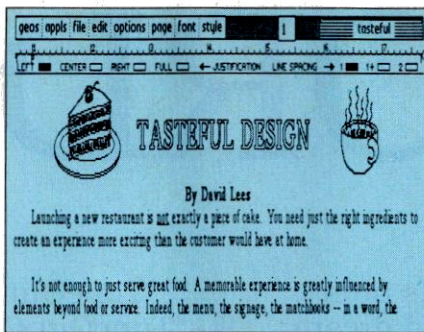

2. WYSIWYG ("What you see is what you get") word processing.

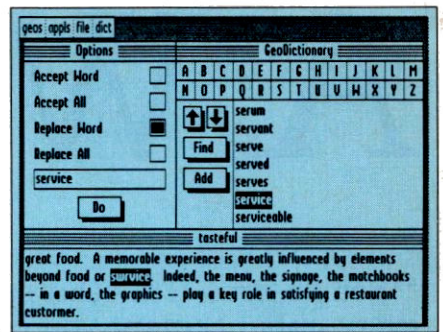

3. Contextual spell checking.

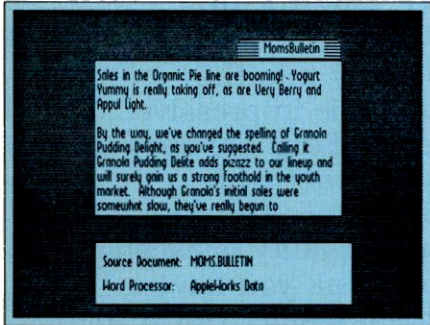

4. Text conversion and importing.

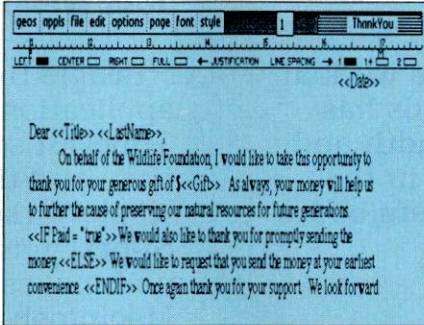

5. Sophisticated mail merging.

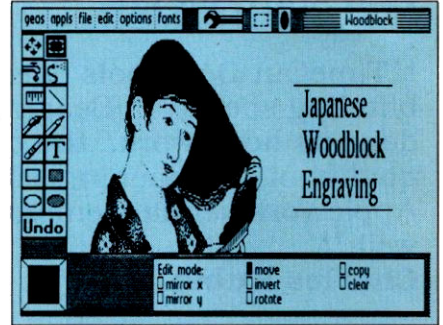

6. Hi res graphics editing.

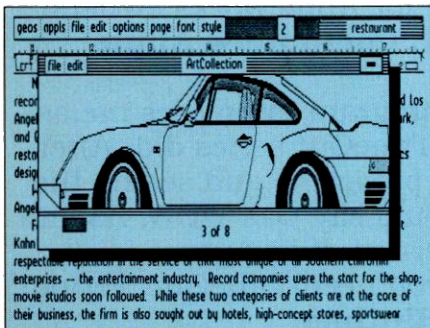

7. Handy desk accessories.

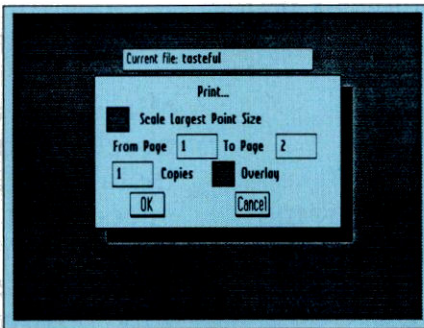

8. LaserWriter printing.

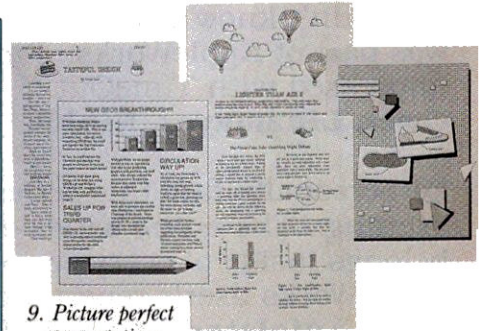

9. Picture perfect presentations.



A WORD FROM

“Beagle Bros’ TimeOut series puts every enhancement you could dream of right inside AppleWorks.”

Paul Statt, inCider

“TimeOut DeskTools does its work at blinding speed . . . Beagle Bros has done its homework...the breadth and quality of this opening salvo in the AppleWorks enhancement wars bodes well.”

Charles Rubin, A +

“TimeOut Graph works seamlessly; if you didn’t know better, you’d swear it was part of AppleWorks...I’m very impressed with TimeOut.”

Owen Linzmayer, Nibble

“I personally find this series very exciting...The entire series of programs belongs inside of every serious AppleWorks user’s repertoire!”

Marc Apfelstadt, Call-APPLE

“The TimeOut series is the best thing to come along for AppleWorks users.”

Lee Hayward, TAWUG

“The TimeOut series programs are excellent AppleWorks enhancements.”

**Warren Williams,
NAUG AW Forum**

“TimeOut UltraMacros is incredible. TimeOut QuickSpell is a work of true genius...I love this program.”

Tom Weishaar, Open-Apple

“Beagle Bros’ foray into the applications arena is impressive...The TimeOut series add-ons are easy to use...and they interact with AppleWorks perfectly...TimeOut SuperFonts print quality is excellent, and makes you think you have a Macintosh hidden inside your Apple II...The TimeOut series is a major breakthrough for AppleWorks owners.”

Gregg Keizer, Compute!’s Apple

“It is rare a program impresses me as much as the TimeOut series did. After installing the programs and seeing the speed, all I could say was WOW. As far as I am concerned, if you use AppleWorks you need TimeOut. Period!”

Jay Wilbur, Uptime

“TimeOut ‘fits’ AppleWorks like a glove and in no time you get the feeling that it ‘belongs’ with AppleWorks...TimeOut SideSpread is terrific...TimeOut FileMaster is indispensable.”

**Ib Thorsteinsson, Robert Grist and
Lorne Walton, Apples B.C. News**

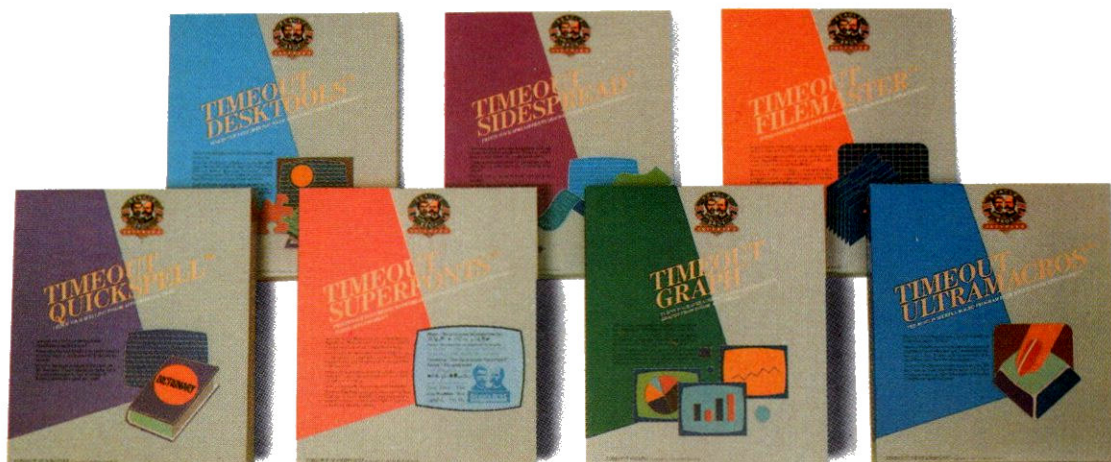

M THE WISE.

“Fabulous!”

Howard M. Adkins, Tucson, AZ

“Installation was a breeze.”

Charles O. Ward, Centreville, VA

“I think you have come as close to a perfect concept as I have seen in computer software.”

Robert L. Davidson III, Princeton, NJ

“The TimeOut series is the best set of AppleWorks add-ons that I have had the pleasure to use in the three years I’ve been using AppleWorks.”

Chuck Newby, San Diego, CA

“Your TimeOut series is EXCELLENT! It is far better than other add-ons!”

Eric C. Mueller, EAFB, AK

“It is so completely integrated into AppleWorks that it’s easy to forget that it’s an add-on.”

Francis E. Old III, Baltimore, MD

“I think that you have really changed the complexion of AppleWorks from a reasonable compromise for the amateur computist to a flexible and powerful program. The whole thing is quite elegant.”

Mark D. Widome, Hershey, PA

The **TimeOut series** is a revolutionary family of products that dramatically increase the power of AppleWorks (version 2.0 and later).

TimeOut QuickSpell (\$69.95) gives you perfectly spelled documents every time. Fast!

TimeOut SuperFonts (\$69.95) makes your documents stand out with dozens of Macintosh fonts in a wide variety of styles and sizes.

TimeOut Graph (\$89.95) extends the spreadsheet’s “what if” capability by producing great looking charts in seconds.

TimeOut UltraMacros (\$59.95) performs tasks at lightning speed by memorizing and repeating any sequence of keystrokes and commands. Includes a powerful programming language too.

TimeOut DeskTools (\$49.95) includes a calculator, calendar, case converter, clipboard converter, clock, dialer, envelope addresser, file encrypter, notepad, page preview, puzzle and word count.

TimeOut SideSpread (\$49.95) prints your spreadsheets sideways in a variety of fonts, sizes and print qualities.

TimeOut FileMaster (\$49.95) gives you total control over all your disk and file handling needs.

Works with what you’ve got. TimeOut is compatible with Applied Engineering and Checkmate desktop expanders.

Never leave AppleWorks again. All of the TimeOut applications are fully integrated with AppleWorks and can be instantly accessed at any time from inside AppleWorks.

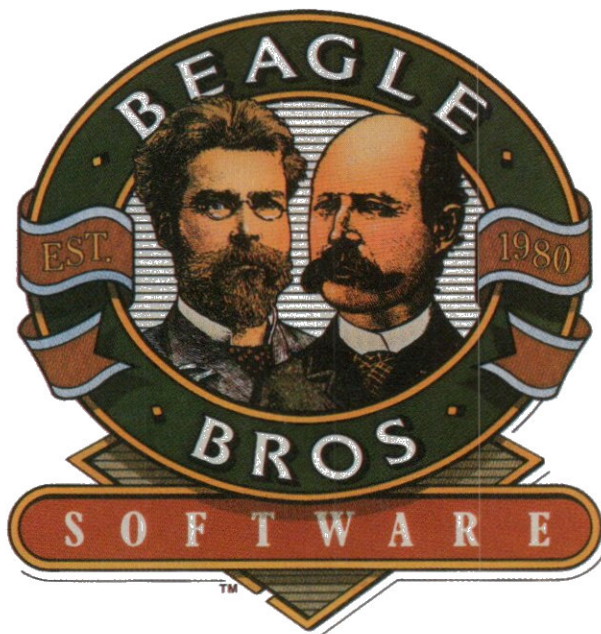

ORDER TODAY!

For phone orders call:
1-800-345-1750 (US)
1-800-992-4022 (CA)

Beagle Bros, Inc.

6215 Ferris Square, Suite 100
San Diego, CA 92121
619-452-5500

ThunderChopper

Introducing ThunderChopper, the new standard of excellence in helicopter simulation! ThunderChopper combines SubLOGIC graphics technology with strategies and tactics by Colonel Jack Rosenow, USAF (Ret.). This simulator truly was a labor of love for the Colonel:

"I'm a chopper pilot with over 9,000 hours of flight time. Let me put you at the controls of an advanced Hughes 530MG Defender. No other helicopter simulator is as responsive to your control input, or as satisfying to fly. Start yourself out on the flight training grounds. My concise documentation will have you flying in minutes.

"Once you've attained a level of flying proficiency, you're ready to train for one of the most important duties a helicopter pilot can perform - the location and rescue of downed pilots.

"After you've mastered flight and rescue techniques you're ready for combat. Multiple scenarios let you test your skills under a variety of combat conditions. Escort ground troops through enemy territory. Or rescue the survivors of a major sea battle. You'll have to become adept at selecting and controlling your ordnance, and at using sophisticated electronic weapon/defense systems to locate, identify, and destroy enemy targets.

"ThunderChopper is the most realistic helicopter simulation you'll ever fly. Try ThunderChopper - the excellence comes through."

Colonel John B. Rosenow, USAF (Ret.)
President, ActionSoft Corp.

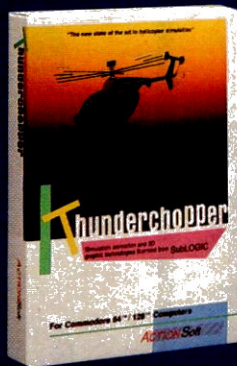
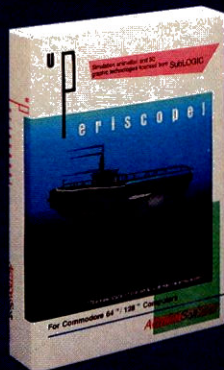

Rescue Mission - scan for flares



Escort troops through enemy territory - search and destroy enemy targets

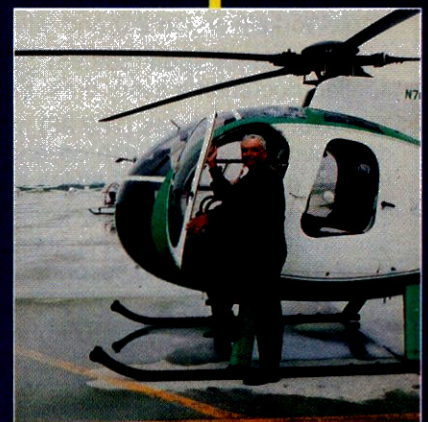

Colonel Jack provided the strategy and tactics for ThunderChopper

See Your Dealer...

Or write or call for more information. ThunderChopper is available on disk for the Commodore 64/128 and Apple II computers. For direct orders please indicate which computer version you want. Enclose \$29.95 plus \$2.00 for shipping (outside U.S. \$6.95) and specify UPS or first class mail delivery. Visa, MasterCard, American Express, and Diners Club charges accepted.

© 1987 ActionSoft Corporation
3D graphics and special effects courtesy SubLOGIC Corp.
Commodore 64 and Commodore 128 are registered trademarks of Commodore Electronics Ltd.
Apple is a registered trademark of Apple Computer, Inc.

-\$29.95-
Better Engineering at a Better Price

ACTIONSoft
"GENERATIONS AHEAD IN STRATEGY ACTION SOFTWARE"
201 WEST SPRINGFIELD AVENUE, SUITE 711
CHAMPAIGN, IL 61820 (217) 398-8388

CIRCLE 122 ON READER SERVICE CARD

A+

The #1 Apple II Magazine

PUBLISHER MARTIN MAZNER
ASSOCIATE PUBLISHER JEFFREY MILLER
EDITOR GARY B. LITTLE
EXECUTIVE EDITOR LISA RALEIGH
MANAGING EDITOR LESLIE STEERE
SENIOR COPY EDITOR EVA LANGFELDT
EDUCATION EDITOR JENNIFER C. BRAWER
EDITORIAL ADMINISTRATOR SHANON B. CULLEN
EDITORIAL ASSISTANT MARY BOHANNON

ART DIRECTOR PETER A. TUCKER
ASSOCIATE ART DIRECTOR FABIAN COOPERMAN
ART ASSISTANT JEFFREY FELMUS
MECHANICAL ARTIST NANCY BROWN
ENTERTAINMENT EDITOR BOB LINDSTROM
GRAPHICS EDITORS MICHAEL CALLERY
 ROBERTA SCHWARTZ
 CHARLES RUBIN
SMALL-BUSINESS EDITOR MICHAEL FISCHER
TELECOMMUNICATIONS EDITOR DAVID THORNBURG
CONTRIBUTING EDITOR

ADVERTISING DIRECTOR DAVID J. EZEQUELLE
 (415) 378-5685
MIDWEST MANAGER THOMAS J. LUTZKE
 (312) 346-2600
NORTHEAST MANAGER THOMAS E. RICHARDSON
 (212) 503-5145
SOUTHWEST MANAGER CATHERINE DAVENPORT
 (213) 387-2100
SOUTHEAST MANAGER PETER STANGEL
 (212) 503-5153
NORTHWEST MANAGER SUSAN SCHLANGEN
 (415) 378-5699

MARKETING MANAGER KEITH NEWMAN
ASSISTANT MARKETING MANAGER ALANE M. BOWLING
ADVERTISING COORDINATOR LISA BURCHARD
ASSISTANT TO PUBLISHER KATHLEEN KUNST
SINGLE-COPY SALES DIRECTOR ROBERT WALTERSDORF
SINGLE-COPY RETAIL SALES CAROL BENEDETTO
CIRCULATION MANAGER CHARLES MAST
CLASSIFIED ADVERTISING KATHRYN CUMBERLANDER
PRODUCTION DIRECTOR CARLOS LUGO
PRODUCTION MANAGER JERI HARRISON
PRODUCTION ASSOCIATE RENEE JOHNSON

EDITORIAL OFFICE 950 TOWER LANE, 18TH FLOOR
 (415) 578-9770
ADVERTISING/BUSINESS OFFICE FOSTER CITY, CA 94404
 ZIFF-DAVIS PUBLISHING CO.
 A DIVISION OF ZIFF
 COMMUNICATIONS CO.
 ONE PARK AVENUE
 NEW YORK, NY 10016
 (212) 503-5209
SUBSCRIPTION INQUIRIES A+, P.O. BOX 2965
 (303) 447-9330 BOULDER, CO 80322

ZIFF-DAVIS PUBLISHING COMPANY
 A DIVISION OF ZIFF COMMUNICATIONS COMPANY

PRESIDENT: KENNETH H. KOPPEL; **GROUP VICE PRESIDENTS:** WILLIAM LOHSE, J. SCOTT BRIGGS; **SENIOR VICE PRESIDENT, MARKETING:** PAUL H. CHOOK; **VICE PRESIDENT, OPERATIONS:** BAIRD DAVIS; **VICE PRESIDENT, CONTROLLER:** JOHN VLACHOS; **VICE PRESIDENT, CREATIVE SERVICES:** HERBERT STERN; **VICE PRESIDENT, RESEARCH:** MARIAN O. WHITE; **VICE PRESIDENT, CLASSIFIED ADVERTISING:** ALICIA MARIE IVANS; **VICE PRESIDENT, CIRCULATION:** BERT LACY; **VICE PRESIDENT, CIRCULATION SERVICES:** JAMES RAMALEY; **VICE PRESIDENT, MARKETING SERVICES:** ANN POLLAK ADELMAN; **VICE PRESIDENT, DEVELOPMENT:** SETH ALPERT; **DIRECTOR OF PLANNING:** GARY A. GUSTAFSON; **PRODUCTION DIRECTOR:** WALTER J. TERLECKI

ZIFF COMMUNICATIONS COMPANY
CHAIRMAN: PHILIP B. KORSANT; **PRESIDENT:** KENNETH H. KOPPEL; **SENIOR VICE PRESIDENTS:** PHILIP SINE; HUGH TIETJEN; **VICE PRESIDENTS:** J. MALCOLM MORRIS, WILLIAM PHILLIPS, STEVEN C. FEINMAN; **TREASURER:** LAURENCE USDIN; **SECRETARY:** BERTRAM A. ABRAMS

A+ The #1 Apple II Magazine (ISSN #0740-1590) is published monthly for \$24.97 one year, \$43.97 two years, and \$57.97 three years. Additional postage \$5 for Canada, \$5 other foreign by Ziff-Davis Publishing Co., a division of Ziff Communications Company, One Park Ave., New York, NY 10016. Second-Class Postage paid at New York, NY 10016 and at additional mailing offices. **POSTMASTER:** Send address changes to A+, P.O. Box 56493, Boulder, CO 80321-6493.

A+ is an independent journal, not affiliated in any way with Apple Computer, Inc. Apple is a registered trademark of Apple Computer, Inc. Entire contents Copyright © 1988 Ziff-Davis Publishing Co., a division of Ziff Communications Company. All rights reserved; reproduction in whole or in part without permission is prohibited. The following are trademarks of Ziff-Davis Publishing Co., a division of Ziff Communications Company: A+, A+, The #1 Apple II Magazine, Rescue Squad, That's Entertainment, Teachers' Toolbox, Tips and Techniques, GamePort, Learning Curve. **PERMISSIONS:** Material in this publication may not be reproduced in any form without permission. Requests for permission should be directed to the Reprints Manager, Jennifer Locke, Ziff-Davis Publishing, a division of Ziff Communications Company One Park Ave., New York, NY 10016. **BPA**

BRIGHT IDEAS

"Over 1/2 Million Satisfied Customers"



IIGS,
IIC, Mac

Grappler c/Mac/GS

Universal Parallel Interface

This popular deluxe parallel printer interface works with an Apple IIGS, IIC or a Macintosh. It supports over 20 different printers, including color models. Pull-down menus, graphics screen dumps and snapshot feature for the Apple IIGS. **\$119**

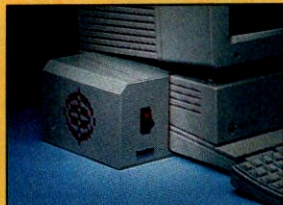

IIGS

JuiceBox™

GS Surge Suppressor/Fan

Provides the IIGS with voltage protection and a quiet "whisper" fan for cooling. Three power outlets for peripherals with automatic switching for user convenience. **Only \$79**

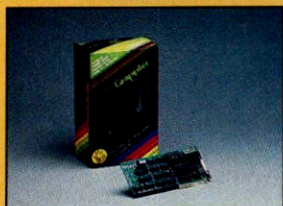

Ile

ProGrappler®

Printer Interface

Best selling printer interface in the world for parallel printers and the Apple Ile. Pull-down menus provide a variety of screen dumps of graphics and text. Over 1/2 million units in use. **\$119**



IIGS

RamPak 4GS™

Memory Sub-System

Provides 512K to 4 megabytes add on memory for IIGS. Includes unique software utilities which gives you up to 350% increased performance over regular memory cards. Uses state of the art 256K x 4 one megabit expansion chips. **\$279**

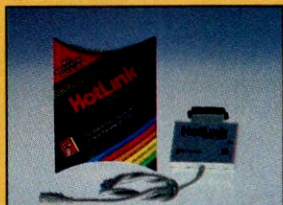

IIC

HotLink™

IIC Printer Interface

This is by far the most economical way to connect a printer to your Apple IIC. The HotLink and a parallel printer can save you up to \$200 over the Apple ImageWriter II printer. **\$69**



Image-
Writer II

ImageBuffer™

Provides 64K buffer (expandable to 128K, or 40 pages of text) to turbocharge your ImageWriter II. Now your computer can work while your printer prints simultaneously. **Limited Special \$59**

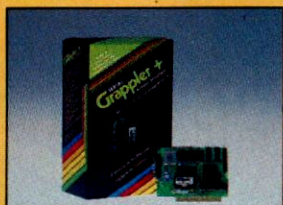

Ile

SERIAL Grappler+®

Interfaces the Apple Ile with the serial ImageWriter II. Provides over 30 text and graphics screen dump commands including full color. A \$40 savings compared to the Apple Super Serial Card. **Only \$89**

ORDER NOW!
1-800-223-8029
 IN CA (714) 779-2772



Or see your local Apple Dealer. We offer only top quality products backed up by a 30 day money back guarantee for direct orders. Immediate delivery.

Orange Micro Inc.

1400 N. Lakeview Ave., Anaheim, CA 92807
 "Quality Apple® products since 1980"

© Orange Micro, Inc. 1987

CIRCLE 108 ON READER SERVICE CARD

▶▶▶▶▶ THE APPLE II NETWORK

COVER STORY

26 APPLE BRINGS NETWORKING TO THE APPLE II

BY GARY B. LITTLE
Apple has finally introduced AppleTalk for the Apple II. Here's what it consists of, how it works, and why you might need it.

35 THE CORVUS NETWORKING ALTERNATIVE

BY TOM VIER
A comparison of AppleTalk and Corvus' Omninet

43 OTHER NETWORKS: ELAN, VNET, DNET, AND CLASSROOM NETWORK

BY ROD WILLIAMS
A quick rundown of other networking options for the Apple II, and a comparison chart "Networks at a Glance"

53 SOFTWARE ISSUES: PRICING, LICENSING, AND UPDATES

BY LISA RALEIGH
Besides the entanglements of setting up hardware, networks also introduce a host of software issues.

73 APPLETALK CABLING SCHEMES

BY DON LANCASTER
Five alternatives for enterprising networkers

EDUCATION

59 THE LEARNING CURVE

BY DAVID D. THORNBURG
The good news and the bad news about networks in the classroom

65 TEACHERS' TOOLBOX

BY JENNIFER BRAWER
A look at curriculum-management software

APPLEWORKS REPORT

97 EDUCATIONAL RESOURCES MAKE THE GRADE

BY DAVID CHESEBROUGH
In this second of a three-part series on the universe of AppleWorks products, we focus on education.

HARDWARE

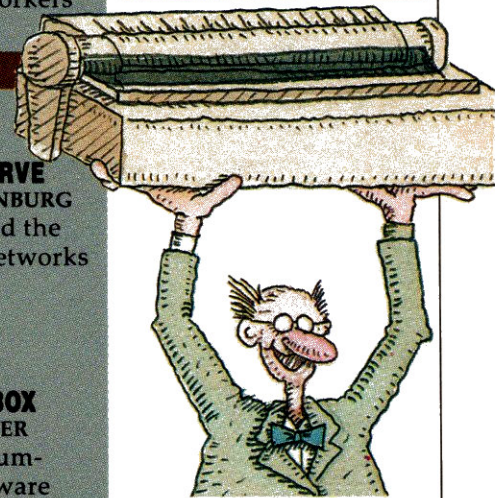

108 PREVENTATIVE PRINTER MAINTENANCE

BY SCOTT BRAINARD
Eighteen prescriptions for a healthy ImageWriter

GRAPHICS

111 SPEAKING OF GRAPHICS

BY ROBERTA SCHWARTZ AND MICHAEL CALLERY
The Graphics Studio marches to its own drummer when it comes to its user interface.

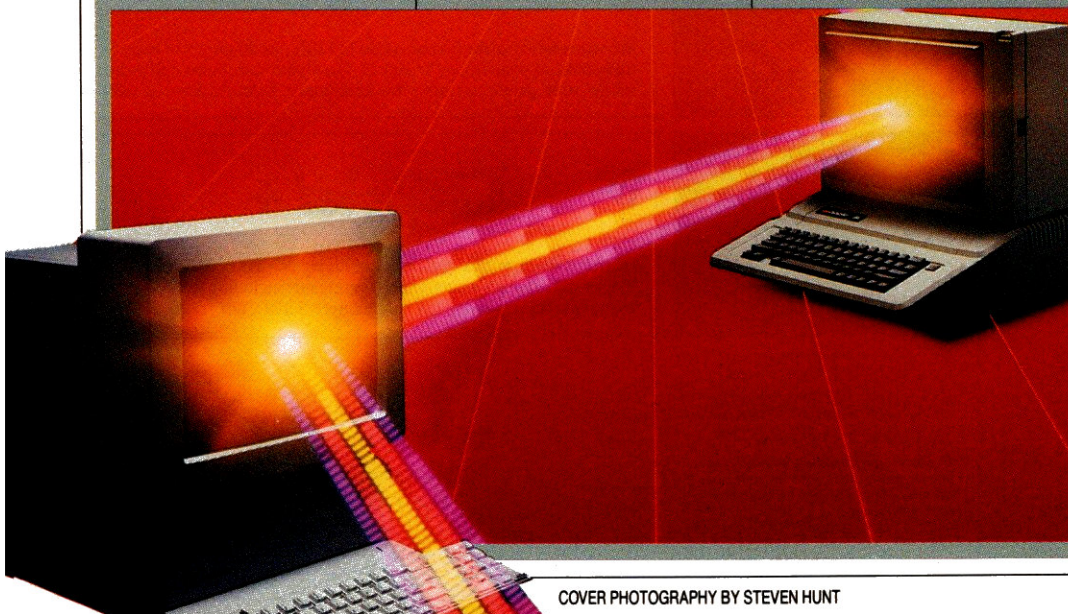

T E N T S

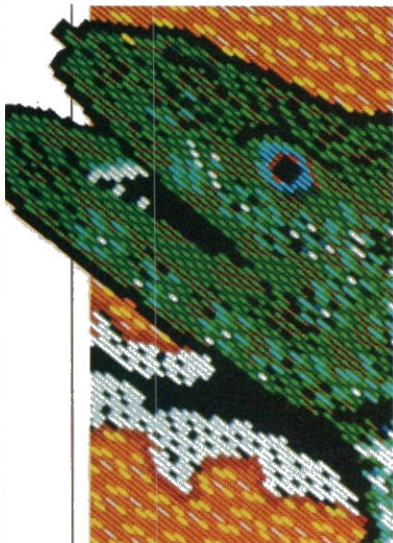

116

GRAPHICS GALLERY

Scenes from the sea from Japan, Bermuda, and the U.S.

RECREATION

119

GAMEPORT

BY BOB LINDSTROM
A preview of eight coming attractions—watch for them soon at a store near you. Plus a IIcs Bard's Tale update.

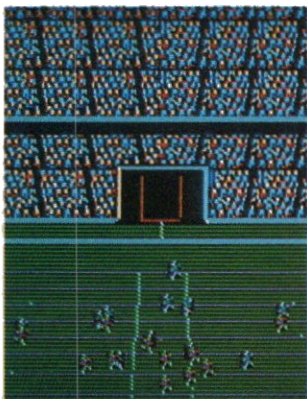

126

ENTERTAINMENT

Following "GamePort" are reviews of Wings of Fury by Brøderbund, Legacy of the Ancients by Electronic Arts, and Ticket to London by Blue Lion.

PRODUCTS

80

PRODUCT SPOTLIGHT

BY PETER TUCKER
The most interesting products of the month for the Apple II

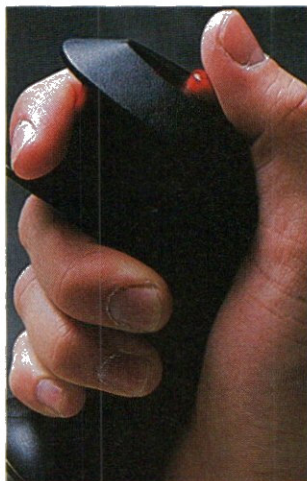

134

PRODUCT ROUNDUP

BY SHANON CULLEN
Products you want to know about—for the entire Apple II family

139

PRODUCT ALL-STARS

The A+ directory of the best Apple II products available

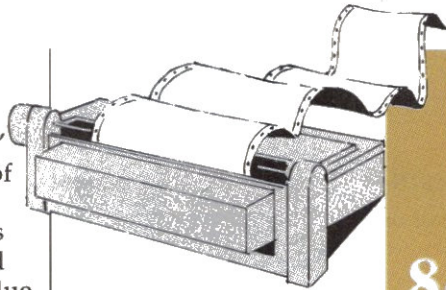

TO THE RESCUE

141

TIPS AND TECHNIQUES

Useful Apple II tips from our readers

152

RESCUE SQUAD

BY GARY B. LITTLE
A printer-activity-check subroutine and how to get your clock to say it's 1988

DEPARTMENTS

9

EDITOR'S PAGE

15

LETTERS

21

NEWSPLUS

BY LISA RALEIGH AND ALANE BOWLING
News and views of the personal-computer industry

142

MARKETPLACE

149

INDEX TO ADVERTISERS

IIcs

UPDATE

84

TWO PASCALS FOR THE IIcs

BY MICHAEL FISCHER
High-level languages are appearing for the IIcs, including Pascal compilers from TML and Orca. Here's how these two Pascals compare.

```
: integer  
: integer  
: real;
```

```
packed  
= integer  
number =  
code, pr
```

91

THE MEMORYSAVER BOARD

BY LARRIE EASTERLY
Checkmate's MemorySaver gives you speedy access to lots of memory for your cs.

Sharpen Your Apple II™ Skills and Build a Great Software Collection

ONLY \$6.65!
Monthly Software for your Apple II (+,c,e,gs) Computer.

Learn From the Experts

Draw on the vast experience of our editors to provide you with carefully selected software you can use each month, from spreadsheets to role-playing games, from telecommunications to accounting to recipe programs. With easy-to-use documentation, you will master each new application with confidence and ease.

Become Experienced Inexpensively

Without investing a fortune, SOFTDISK will help you to see why your Apple II is the most versatile and powerful tool you own. You will know more about your Apple, its capabilities, and software for it, than you would have thought possible. At \$6.65 a month, SOFTDISK is the best value in software today.

Try our Monthly Software for Three Months

Every month your postman will bring you the latest issue of SOFTDISK, contained on two unprotected 5¼" diskettes. Each issue is chock-full of great software, including utilities, games, home and business applications, and educational programs. Order now and you will receive 400 Print Shop graphics absolutely free.



Reviewers Love SOFTDISK!

"Having now looked at the three 'disk magazines' that I know of, I have to tip my hat to Softdisk, who seemed to have produced the most professional-looking disk, more programs, and at the least cost." . . . APPLE CART, NOV/DEC 1987

"■■■■■" INCIDER, APR 1987

Contents of Issue #76

- **Tharolian Tunnels Complete** arcade game from Datamost™!
- **No-Liners** EXECable routines.
- **Twittering Birds** Bird call tutorial.
- **World Cities** Geography Quiz.
- **Hangman** Unbeatable version.
- **Pixel Puzzler** CATastrophic hi-res jigsaw puzzle.
- **Volume Control** Units of volume measurement conversion program.
- **The Crossword Machine** Hi-res crossword puzzle game.
- **And Much More**, including some great April Fool's Day fun!

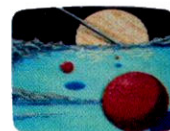
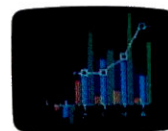

Apple II is a trademark of Apple Computer Inc. Print Shop is a trademark of Broderbund Software.

Available at Waldenbooks, B. Dalton Booksellers, and fine bookstores everywhere (cover price \$9.95). Commodore 64/128 and IBM PC versions also available.

Yes! Please rush my free 400 Print Shop Image and start my 3 month subscription to SOFTDISK for my 64K Apple II+, IIe, IIc or IIgs for only \$19.95 postage paid. I understand that this is a **trial subscription** and that I am under no obligation to continue beyond three months. (*Overseas \$27.95*)

Name _____

Address _____

City _____ State _____ Zip _____

Telephone _____

VISA/MC AmEx Payment Enclosed

Card # _____ Exp. Date _____

Call Toll Free 1-800-831-2694

(In Louisiana call 1-318-221-8718) A+058

SOFTDISK • P.O. Box 30008 • Shreveport, LA 71130-0008

CIRCLE 222 ON READER SERVICE CARD

FREE "Premium Collection" – a collection of 400 images for use with Broderbund's Print Shop™ program – when you order the next three issues of SOFTDISK for your Apple II or compatible computer. Image categories include:

Disk 1
 Buildings and Places
 Monograms
 Food and Plants
 Games and Hobbies
 People and Sports
 Tile Patterns

Disk 2
 Artifacts
 Signs and Symbols
 Graphic Designs
 Animals
 Holidays
 Transportation

Your Satisfaction Guaranteed

If you are not satisfied with your purchase for any reason, return your first issue for a full \$19.95 refund. The 400 Print Shop Images is yours to keep. You can't lose.

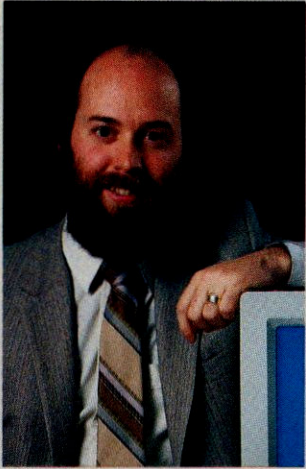

APPLE II NETWORKS

Apple's announcement last March of AppleTalk products for the Apple II family makes *network* the hot buzzword for 1988. Simply put, a network is a group of computers and peripherals connected together in such a way that every workstation can communicate with any other on the network. With a network in place, users can share such high-ticket items as laser printers and high-capacity hard-disk drives. They

can also exchange disk files with other computers on the network, even if those computers are of different types. Therefore, networks tend to increase a group's efficiency and, of course, its productivity.

Networks are useful for all small work groups, whether they are made up of students in a classroom or colleagues in a business. But there is a price to pay, and I'm not just talking about the cost of the hardware and software. Networks are notoriously difficult to set up and maintain, although I will agree that AppleTalk is simpler than most. In fact, most require a network administrator, an individual responsible for assigning user names and passwords, configuring the network, and troubleshooting when things go wrong. And when things do go wrong, tracking down the source is frequently difficult, given that the network puzzle has so many pieces. Nevertheless, the benefits of a network usually outweigh the liabilities.

Curiously, networks also cause problems for software developers. First, developers must tackle the issue of how to write a program that works properly when more than one network user tries

to run it at the same time. Then they have to worry about how to price the program to get a decent return on their investment. They just can't sell a program for a conventional price if every student in a classroom is permitted to run it over the network, for example.

The purpose of this issue of *A+* is to raise your network IQ. We introduce you to the major Apple II networks (AppleTalk, Omninet, VNET, ELAN, Classroom Network, and DNET) and explain how they work, how much they cost, what their best features are, and what features they're missing. We'll also explain the jargon peculiar to

I expect the number of Apple II networks to grow dramatically in the coming year.

networks, elaborate on software-licensing issues, and let you know what kind of network-compatible software we can expect to see from publishers in the near future.

I expect the number of installed Apple II networks to grow dramatically in the coming year. *A+* will be closely monitoring developments in network hardware and software. Expect to read follow-up stories in future issues.

CD-ROM, Where Are You?

Apple also announced a CD-ROM drive for the Apple II and Macintosh, the AppleCD SC, in March. It uses optical technology to read (but not write to) compact discs containing up to 550 megabytes of data; that data can represent text, sound, or video information. The future for CD-ROM technology seems bright, but I won't get too excited about it until I see more than the two or three CD titles now available for the Apple II.

So I'm on the prowl for Apple II CD developers—when I've got products in my hand, you'll be sure to hear about them here in the pages of *A+*. First

EDITOR'S PAGE

CARMEN STRIKES AGAIN!



WHERE IN EUROPE IS CARMEN SANDIEGO? SWEEPSTAKES

WIN A TRIP TO EUROPE FOR TWO; 4 days in London, 4 days in Paris; sightseeing tours, theater, 1st class accommodations, airfare and more! Sweepstakes starts March 15, 1988. Entries must be received by June 15, 1988.

SEE YOUR FAVORITE BRØDERBUND RETAILER FOR COMPLETE ENTRY DETAILS. NO PURCHASE NECESSARY.

The thick night fog is torn by the shriek of a whistle as the Orient Express hurtles through the sleeping countryside. In one of the sleek train's compartments, a dim light illuminates the face of a striking woman. A slight smile plays over her lips: If all goes according to plan, when the citizens of Venice awake, they will find every last one of their precious gondolas missing. . .

Carmen's back! And you're going to have more thrills than ever as you chase her and her new gang. This time, they're out to steal the priceless treasures of Europe. They *must* be stopped!



ON-SCREEN MAP OF EUROPE

Start out at the scene of the crime. Question witnesses, search for

clues, and talk to a local tipster. Then decide on your next move. To help you unravel the clues, you'll have Rand McNally's 96-page, full-color *Concise Atlas of Europe*™

Before you're done, you'll know Europe inside out. But best of all, you'll have so much fun, they'll have to drag you away from the computer.

► NEW VILLAINS, new locations, new clues, new treasures, new challenges! ► NEW CRIMESTOPPER'S COMPUTER NOTEBOOK for keeping track of your clues. ► NEW FACTFINDER'S DATABASE shows you how a data base can help you interpret clues faster. ► GAMES GET MORE CHALLENGING as you gain more experience.

Brøderbund®

HOW TO ORDER: Look for our products at your local software retailer or to order direct call 1-800-527-6263, 8:00am-5:00pm PT, with credit card orders (VISA, MasterCard, Amex). To order by mail, send check, money order or credit card information to Brøderbund Software-Direct, P.O. Box 12947, San Rafael, CA 94913-2947. California residents add 6% sales tax. For shipping and handling, add \$3.50 for one program and \$1.00 for each additional program ordered. Allow 4 weeks for delivery. Direct orders carry a 10-day money-back guarantee.

WHERE IN EUROPE IS CARMEN SANDIEGO?™ is available for Apple II® IBM PC®/Tandy® \$44.95, Commodore 64® \$39.95. **WHERE IN THE WORLD IS CARMEN SANDIEGO?®** is available for Apple II, IBM PC/Tandy \$39.95, Commodore 64 \$34.95. **WHERE IN THE U.S.A. IS CARMEN SANDIEGO?™** is available for Apple II, IBM PC/Tandy \$44.95, Commodore 64 \$39.95. **TEACHERS:** School Editions and Lab Packs are available for all CARMEN SANDIEGO programs.

Apple, IBM, Tandy and Commodore are registered trademarks of Apple Computer, Inc., International Business Machines Corp., Tandy Corporation and Commodore Electronics, Ltd., respectively. The Orient Express name is a designation of the French Railways. © 1988 Brøderbund Software, Inc.

ALL PRICES ARE SUGGESTED RETAIL.

54CMA

EDITOR'S PAGE

stop: the Microsoft CD-ROM Conference in Seattle.

AppleFest

The AppleFest show in San Francisco last September was exciting. It brought together under one roof (for the first time in a long, long time) most of the major Apple II hardware and software publishers and included many excellent panel discussions and seminars.

Good news for those who couldn't make it to the Bay Area: Another AppleFest is just around the corner, this time in Boston, May 20-22. *A+* will be an exhibitor once again, and all our staff editors will be there. I'm also arranging for columnists Mike Fischer, Roberta Schwartz, Michael Callery, and Bob Lindstrom to appear. We'll be leading seminars, checking out hot new products, and generally making ourselves visible. We look forward to meeting as many of our readers as possible.

Exit Stage Left

With this issue, *A+* enters a new editorial era. Fred Davis, who was named *A+*'s first technical editor more than four years ago and who eventually moved up the ladder to become editor-in-chief (in other words, the king of the castle), has left us to become editor-in-chief of our sister publication *MacUser*. Under his direction, *A+* won the Computer Press Association's prestigious "Best Computer Magazine" award last year.

Fred's perceptive, yet often controversial, opinions on Apple II issues will certainly be missed. (His atrocious puns will not!) Of course, he's moved only a few doors down the hall, so, as *A+*'s new editor, I'll still have the benefit of hearing those opinions regularly. So Fred is still with us in spirit, and that's good news for all of us. Congratulations, Fred, and all the best in the crazy world of the Macintosh. +

GARY LITTLE/EDITOR

Your child's first step is the most important.

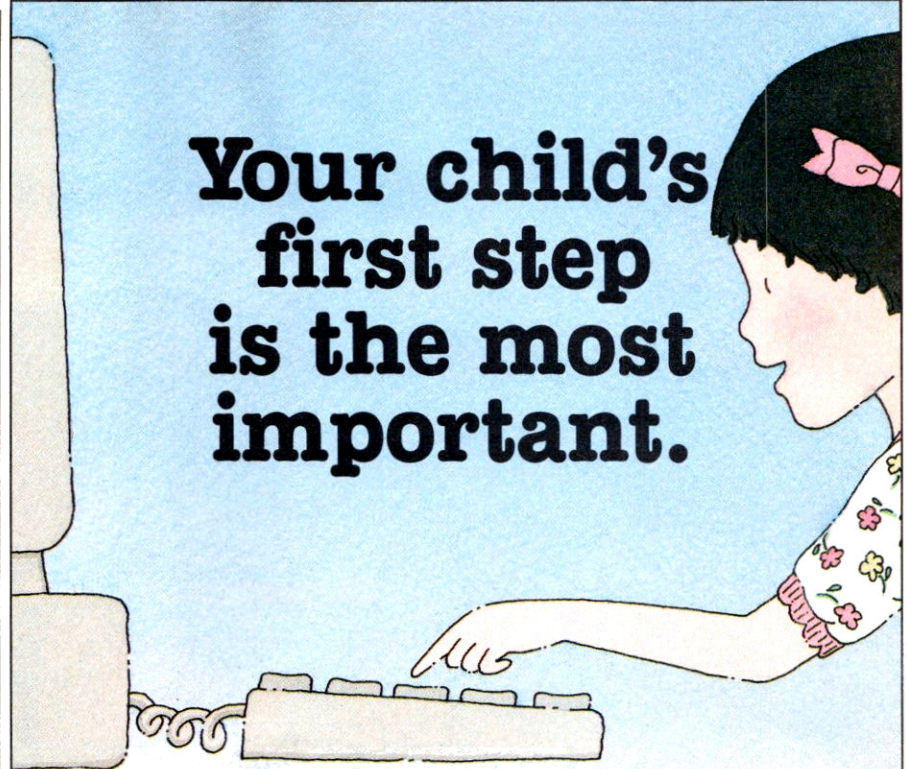

Introducing MATH and ME.™ Your child's first math program.

Your child's first experience with math will last a lifetime. And **Math and Me** will make that first math experience positive and rewarding.

Playful monkeys teach your child all about shapes, numbers, patterns, and simple addition. Colorful graphics and animation make learning exciting and effective.

And **Math and Me** is easy to use.

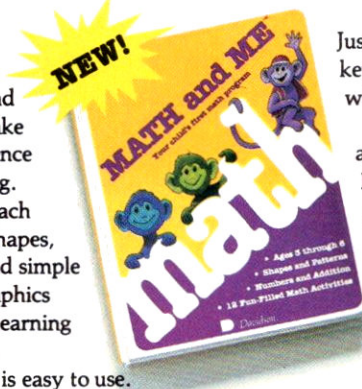

Just tap a few keys on the keyboard or point and click with a mouse.

Designed by teachers who are also parents, **Math and Me** instills confidence in your child while building a solid foundation in math.

Math and Me — the important first step in your child's future.

For ages 3 through 6.
\$39.95 suggested retail

Call us for the name of the software dealer nearest you.

800-556-6141 or 213-534-4070 (California only)

Available for Apple® IIGS, IIc, IIe (128K extended 80-column card req.) and IBM® (color graphics card and 256K req.), and most compatibles. Ask your dealer for new **Math and Me** workbooks.

WIN \$100 WORTH OF SOFTWARE. Clip and return this coupon to enter our monthly drawing for \$100 worth of free Davidson educational software programs for all ages. We'll also send information on our full line of programs for students and teachers.

Name _____

Address _____

City, State, and ZIP _____

Type of Computer _____



Davidson.

Teaching tools from teachers

Davidson & Associates, Inc.
3135 Kashiwa Street, Torrance, CA 90505

A+ M 5/88

*NO PURCHASE NECESSARY. Offer ends December 31, 1988. Void wherever prohibited or restricted by law. Odds of winning will be determined by total number of entries received.

FREE.



BUY 2, PICK 1 FREE!

We're sure that amongst all these choices, there's one that you'd like to pick - for free. So, go ahead - exercise your free choice by visiting your nearest retailer. Buy any two of these best-selling Electronic Arts products between April 1, 1988 and June 30, 1988 - and pick a third one for free!

To redeem your free software, simply fill out either your retailer's coupon or the coupon in this ad, and mail it with proofs of purchase (see requirements on coupon) along with \$3 per free product for shipping and handling (U.S. Funds). If you can't find a participating retailer, order direct by calling 800-245-4525 throughout the U.S. and Canada. Just tell us which products you want to buy, and what you want for free. Have your Visa/MC numbers ready.

HERE ARE YOUR CHOICES

- Amnesia
- Arcticfox
- The Bard's Tale
- The Bard's Tale II
- Chuck Yeager's AFT
- Deathlord
- Demon Stalkers
- Dragon's Lair
- Earl Weaver Baseball
- EOS: Earth Orbit Stations
- Get Organized
- GrandSlam Bridge
- Instant Music
- Instant Pages
- IntelliType
- Legacy of the Ancients
- Marble Madness
- Patton vs. Rommel
- PHM Pegasus
- Return to Atlantis
- Skate or Die
- Skyfox II
- Starflight
- Strike Fleet
- World Tour Golf
- B/Graph
- The Consultant
- DEGAS Elite
- DiskTools Plus
- Homepak
- IS Talk
- Outrageous Pages
- PaperClip Publisher
- PaperClip with Spellpak
- PaperClip III
- Thunder!
- Timelink

Product availability varies by computer format.
Ask your retailer or call (415) 572-2787 for details.

PICK ONE.



AND YOUR DELUXE CHOICES

Choose from our Deluxe Creativity Series for your purchase products. Or, redeem free Deluxe software when you buy any two of these Deluxe products:

- DeluxeMusic
- DeluxePaint
- DeluxeProductions
- Construction Set
- DeluxePaint II
- DeluxeVideo



ELECTRONIC ARTS®

All products are registered/trademarks of Electronic Arts.

PICK 1 FREE! MAIL-IN COUPON

Please send my free software to the following address. I have enclosed the required proofs of purchase (specified below) and \$3 (check or money order payable to Electronic Arts) for shipping and handling.

PLEASE PRINT

Name _____

Address _____

City _____ State _____ Zip _____

My free software choice _____

The computer I own _____

PROOF OF PURCHASE REQUIREMENTS: Send the following original items: 1) the dated cash register tape(s) or sales receipt(s) showing the two products you purchased, and 2) find the Command Summary Card or the Manual (where no Command Summary Card exists) inside each package, cut off the part number on the back, lower portion of the Card or Manual.

MAIL TO: Electronic Arts, BUY 2, PICK 1 FREE, P.O. Box 7530, San Mateo, CA 94403. Only valid requests postmarked by July 15, 1988 will be honored. Allow 3-6 weeks for delivery.

CIRCLE 171 ON READER SERVICE CARD

A+ MAGAZINE INVITES
COMMENTS FROM READERS.
PLEASE WRITE TO US AT:
A+ MAGAZINE
950 TOWER LANE, 18TH FLOOR
FOSTER CITY, CA 94404

CAT DOCTOR PLUSES

Dear A+: In the "All-Stars" coverage of disk utilities in the December 1987 issue of A+, I find that Gary Little did not give Glen Bredon's ProSel utilities enough credit compared to the other programs. Although I realize that the article was not trying to compare the different programs, I feel that some of the features that made ProSel first on the list were ignored in the article.

First, Bredon's Cat Doctor can be completely mouse-driven—the description made no reference to this feature, which alone makes the program ten times better than Copy II Plus for those of us with mice.

The second missed feature is that Cat Doctor allows users to sort files in a directory, using the open-apple and arrow keys. The latest version of Copy II Plus that I have lets you sort only alphabetically, not into any order as Cat Doctor does. Anyone trying to make a system file first in a directory listing, using Copy II Plus, has a lot of work to do, since you can only alphabetize the catalog. Cat Doctor allows you to move the file easily with the open-apple/arrow-key combination and can sort alphabetically by date (of either creation or modification), by file type, or alphabetically by file type.

Even though Cat Doctor can use a mouse, users without that luxury will find the program just as easy to use, since you also have the option of pressing a single character key to access a function. In other words, to copy files, you either use the mouse to select Copy, use the arrow keys to move the highlighted bar to the function, or simply press C to get that function to execute.

I realize this letter sounds more like a review than anything else, but I just wanted to point out some things that were ignored.

JOHN M. WARGO
AKRON, OH

Thanks for the testimonial. We tried to keep the All-Star write-ups as brief as possible because we had so many products to include in the issue.—Editors

DB MASTER LEARNING

Dear A+: Thank you for highlighting DB Master version 5 as one of your All-Stars in the December A+ and the new "Product All-Stars" listings. There are, however, a few comments I would like to make.

First, DB Master is not nearly as difficult to learn and use as Mr. High stated. Although he did mention that he was reviewing a prerelease version of the program, he failed to point out that he was

LETTERS TO THE EDITOR

also using a prerelease instruction manual, which had no tutorials. As page 1 of that manual states, "This is a pre-release version of both the program and the User's Guide . . . The final version of the User's Guide will include additional sections, such as step-by-step tutorials and appendixes."

As with any program, having the tutorials is going to make the learning process much easier. To use High's analogy, imagine trying to learn how to fly an airplane using only the blueprints and the service manual!

I assume High's review also led to your statement in the "Product All-Stars" listing that DB Master is "not suitable for merely routine tasks." I couldn't disagree more, and I suspect that most of our users feel the same way.

BARNEY STONE, PRESIDENT
STONE EDGE
TECHNOLOGIES, INC.
MAPLE GLEN, PA

Although the version we reviewed was indeed "prerelease," it was nonetheless the version that Stone Edge was selling. The company has a unique policy of marketing prerelease software and then updating its users

when the final version arrives. Since we reviewed what was commercially available, we stand by our review. We agree, however, that the tutorials now make DB Master easier to use than before.—Editors

Ile-TO-IIGs UPGRADE

Dear A+: I am writing to complain about Apple's Ile-to-IIGs upgrade kit. I feel that it is extremely poor and misrepresented. First, it is overpriced. Apple says it has a suggested retail price of \$499, which is deceiving. Yes, it does cost only \$499 for the IIGs motherboard and base pan, but that price does not include installation charges (which are left up to individual dealers), a mouse, and a numeric keypad. The mouse you must buy for an additional \$100 be-

LETTERS

cause almost all IIGs software is mouse-driven. Although the numeric keypad is not essential, it is included with a new GS and makes numeric entry smoother. These additions bring the price of an upgrade kit up to at least \$599 plus installation charges.

Second, Apple tells us that the upgrade kit will make your IIE a fully functional IIGs when, in fact, it does not. At the same time Apple released the upgrade kit, it also released an internal cooling fan, which you cannot use with an upgraded IIE because it is too large to fit into the IIE's case. Also, some IIGs RAM cards that use a piggy-back card cannot be used in an upgraded IIE. The IIGs has been out only a year and a half, and if there are already cards that don't work

with the upgraded IIE, I am sure there will be more to come.

I am not criticizing Apple for trying to give IIE owners a chance to upgrade, but what's the point, if it isn't totally compatible and is more expensive than buying a new IIGs and selling your old system? Since the upgrade kit should be released within a few months, I think other IIE owners should be informed of these factors.

FRANK LAWERENCE
PITTSBURGH, PA

The upgrade kit has, in fact, been available for more than a year. Our understanding is that Apple hasn't sold very many of them, for just the reasons you describe. Please see our February 1987 cover story for a fuller description of the economics of upgrading vs. buying a new IIGs. We favored the latter option.—Editors

The Wait Is Over! 2400 Baud For Your Apple II Is Finally Here

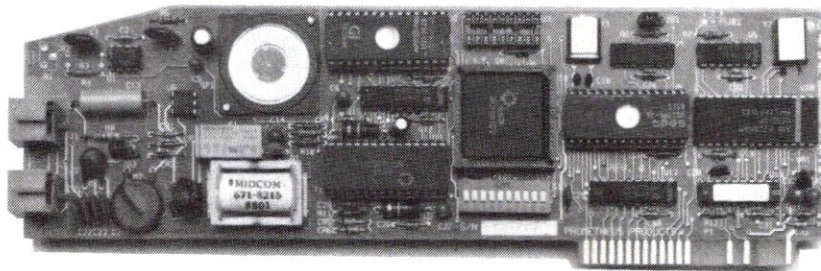

Introducing The ProModem 2400A From Prometheus Products

The new ProModem 2400A is an intelligent internal modem for the Apple II, IIE, and IIGs personal computers.

The ProModem 2400A is based on the latest low power CMOS VLSI technology, allowing all of the features of the 2400A to be incorporated into an Apple internal card.

It's fully Hayes compatible, so it will work with all of the popular communications programs. In addition, we've included our ProCom-A communications software to get you communicating with your 2400A right away.

The ProModem 2400A represents a real value in today's marketplace. Compare our \$269 price with the competition, and you'll see why. And if the features

of our modem and ProCom-A software weren't enough, we've added valuable coupons for free access to a number of popular on-line services. If you've been waiting for a full feature, competitively priced 2400 baud internal modem for your Apple II computer, the wait is over.

We've been making expansion products for the Apple II series for 7 years. So when it comes to modems for your Apple II, look to Prometheus for quality and value.



PROMETHEUS
PRODUCTS, INC.

Prometheus Products, Inc.
7225 SW Bonita
Tigard, OR 97223
(503) 624-0571

PACKET-RADIO SPECIFICS

Dear A+: Regarding the packet-radio article in the November 1987 issue of A+, I would like to know if any software is specifically designed to handle the communications requirements for packet-radio communications using an Apple IIE. Your article was a short general-interest story on the subject but lacked product references. I have done some research and found several programs designed for packet radio and Macintosh or IBM computers but no Apple IIE computers. I'd appreciate any help on this matter.

ROBERT J. FRANTZEN
LAS VEGAS, NV

Author Gabe Wiener responds: Most packeteers use ordinary terminal software. A packet-radio TNC (Terminal Node Controller) connects to a computer in the same way that a serial modem does. Therefore, any terminal package capable of sending to a serial port is fine for packet radio. Unlike modems, all TNCs currently on the market do not use the same set of commands, and, as a result, little specialty software is developed exclusively for packet radio. Depending on the brand of TNC you are planning to use, some software may be available from the manufacturer. You might also be able to find some public-domain software for your TNC. The Ham Radio Forum on CompuServe (G HAMNET) will probably have such programs in its data libraries.

CIRCLE 229 ON READER SERVICE CARD

Why MultiScribe GS 3.0 is the Best Word Processor for Your Apple IIGS.

1. MultiScribe GS™ 3.0 is the fastest, most powerful WYSIWYG word processor for the Apple® IIGS™

What you see on the MultiScribe GS screen is what you get when you print out—no confusing control codes on-screen, no unexpected formatting problems when you print.

2. MultiScribe GS was written especially for the Apple IIGS. So you get a word processor that will grow as your GS grows and work with new GS software and hardware enhancements.

3. MultiScribe GS is much easier to learn and use.

Because MultiScribe GS follows the famous Apple Interface guidelines, the same cut-and-paste editing and ruler-based formatting that made the Macintosh™ revolutionary make MultiScribe GS easier to learn and use than old-fashioned text word processors.

4. MultiScribe GS produces the best printouts of any GS word processor.

MultiScribe GS comes with an exclusive print driver that makes your ImageWriter printouts look better than anything you can create with any other GS word processor. And it prints beautifully on the LaserWriter, too.

5. MultiScribe GS now has the best on-line spell checking and thesaurus ever available on an Apple II.

MultiScribe GS 3.0 features the 80,000-word Merriam-Webster/Proximity spell checker and thesaurus. An on-line spell checker that checks for misspellings in your documents and suggests a list of possible alternative spellings for each misspelled word. And a thesaurus that uses 40,000 meaning-based entry points to generate *over 470,000* true synonyms.

6. MultiScribe GS reads AppleWorks files directly.

Add graphics, fancy type styles, and LaserWriter fonts to AppleWorks files. And use the MultiScribe GS spell checker to make all your AppleWorks files letter perfect.

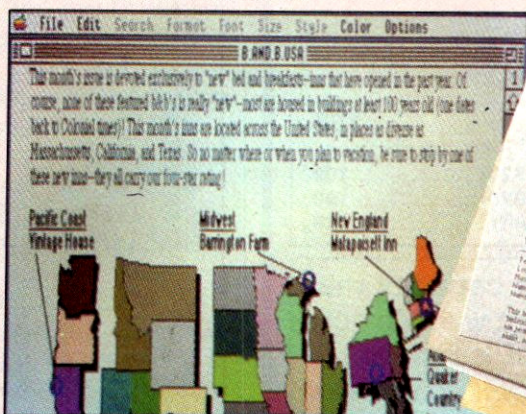

MultiScribe GS lets you combine graphics and text quickly and easily. Your ideas go from screen to page—without surprises.

7. MultiScribe GS works with all major IIGS graphics programs.

MultiScribe GS is compatible with every major GS graphics program—including TopDraw™, PaintWorks Gold™, Deluxe Paint II™, and 8/16 Paint™. No other program supports all these different graphic formats.

8. MultiScribe GS offers more graphics options than any other word processor.

With built-in structured drawing, you can draw lines, boxes, hollow and filled ovals, circles, and rectangles. Place graphics behind or in front of text. Use colored shapes to highlight reversed-out text. Place boxes around paragraphs and use lines to create rules and borders.

9. MultiScribe GS has complete keyboard commands.

Cursor movement, scrolling, text editing, and deleting can all be done with or without a mouse—giving you the best of both worlds.

10. "MultiScribe GS gives you the most bang for your buck"* (inCider magazine).

Nibble says that "MultiScribe GS does just about everything you would expect a full-featured word processor to do, and then some"† —and at \$99.95, it costs less than word processing programs that don't do half as much.

Of course, there are many other reasons why MultiScribe GS is the best word processor

for your Apple IIGS. To find out more, just call 800/233-4088 (in Texas call 713/668-0743). Or ask your dealer for a demonstration. And see why **A+** magazine called MultiScribe GS "the first IIGS word processing program to attain real stature."***



MultiScribe GS
Word power made easy.

StyleWare, Inc.
5250 Gulfmont Suite 2E
Houston, TX 77081

512K Apple IIgs Required • 768K Recommended.

*inCider, November, 1987, **A+, December, 1987, †Nibble, October, 1987
MultiScribe, MultiScribe GS, TopDraw, StyleWare, and the StyleWare logo are trademarks of StyleWare, Inc. Apple, ImageWriter and LaserWriter are registered trademarks of Apple Computer, Inc. Apple IIGS is a trademark of Apple Computer, Inc. PaintWorks Gold is a trademark of Activision, Inc. Deluxe Paint II is a trademark of Electronic Arts, Inc. 8/16 Paint is a trademark of Baudville, Inc.
Merriam-Webster/Proximity Linguibase (c) copyright 1984 Proximity Technology Inc., Merriam-Webster, Inc.

CIRCLE 155 ON READER SERVICE CARD

NOW TOLL FREE:
1-800-777-2822

ORDERS ONLY

lle/llc/llgs

Want the best, easiest-to-use & only 80 column RAM card on the market w/BATTERY BACKED-UP RAM options (unlike Ramworks III™), that save programs like AppleWorks for years — at the best price & most support? Buy Checkmate's **MULTIRAM RGB CARD™** from us! 100% compatible w/all 3rd party software/hardware, (RGB monitor not required), 80 columns/Double Hi-Res! Direct substitute for Apple's 80 col card or Ramworks. **FREE APPLEWORKS EXPANDER/RAM DISK/RAM LOAD/& MORE W/EVERY CARD, 5 YR WARRANTY, 15 DAY MULTIRAM MONEY BACK GUARANTEE & FREE SOFTWARE UPDATES ONLY FROM US!** Schools & approved PO's welcome.

MultiRam MultiRam RGB Card lle Card	MultiRam-PLUS Piggyback
64k MultiRam ... 154. 109.	256k MultiRam Plus 209.
320k MultiRam ... 174. 144.	512k MultiRam Plus 267.
512k MultiRam ... 215. 189.	1024k MultiRam Plus (32x256k) ... 359.
768k MultiRam ... 258. 229.	1024k MultiRam Plus (8x1024k) ... 439.
1024k MultiRam ... 289. ← ← ←	2-4 meg MultiRam Plus Call.
	Battery/AC Kit (for Plus) 36.

MultiRam CX easily expands your llc to 640k and has a CX+ Piggyback to add another 512k (1152k total)! It's 100% compatible with all llc software/hardware & upgradable — all at about 50% less power than Z-RAM™. SAME SOFTWARE & 5 YR WARRANTY AS ABOVE.

512k MultiRam CX	187.
512k MultiRam CX+ (req CX)	209.
1024k MultiRam CX/CX+ Combo	364.

Cermetek 1200 internal modem lle/ll+/llgs	138.
(+ FREE Source & Compuserve subscription/ProTERM™ Setup Instructions)	
1200 Baud universal ext modem (llc/llgs/Mac/IBM. Cables \$20)	109.
2400 Baud universal ext modem (llc/llgs/Mac/IBM. Cables \$20)	195.
ProTERM Modem Software 2.0 (NEW—Best Modem Software)	79.

MultiRam gs RAM cards have 1/3 larger capacity that gsRAM™ — 2 megs, the most versatile card with Memory Saver, 5 yr warranty, free software, less cost, less hype.

256k MultiRam gs	139.	NEW
512k MultiRam gs	179.	NEW
1024k MultiRam gs	249.	NEW
2 meg MultiRam gs	499.	NEW
MemorySaver gs card	119.	
(Battery protects most gs RAM cards — even Apples')		
Memory Saver Batteries (6 AA Nicads)	18.	
Memory Saver Extender (more space & more cards)	45.	

256k Q card for lle (Ext 80 col + more)	99.
CMS/ProAPP/other 20/40/60 Meg Hard Drives (any comp)	Call
Prairie Power llc/Laser 8 hr battery/case	130.
Apple lle Enhancement Kit	59.
Apple 3.5 800k Unidrive (lle/llc/)	324.
Apple llgs 3.5 800k drive	339.
Apple llgs 100% Compatible Drive (daisy chainable too!)	179.
14" RGB Monitor (llgs/lle/llc-Cables extra)	306.
Mappler Compatible Apple-IBM RGB converter (lle/ll+)	42.
Copy II Plus 8.x (NEW—Best 3.5/5.25 Utility)	27.
Timeout UltraMacros (Best AW stepsaver/Macro)	43.
Timeout DeskTools/Filemaster/Sidespread (ea)	37.
Timeout QuickSpell (Best AW Spell Checker)	49.
Timeout Superfonts (AW Fonts + More)	57.
Timeout Graph (AW Graphs + More)	61.

Terms: Add \$4-Ground/\$6-Air shipping & phone # to each U.S. MultiRam card order (foreign orders/FPO/APO extra). Add 3% for MasterCard/Visa/Amex (include expir date) & P.O.'s. For fast delivery send Cashier's/Cert check/MO. C.O.D. (add \$5) & pers checks accepted (allow 16 days). Tax res add 8% tax.

Telex: 6502969684 MCI UW • MCI 2969684

Ordering: CALL or PRINT name & address, Res & Bus phone, credit card name/number/expire date where appropriate, qty/description/price/shipping charges if known. Call for questions.

Prices subject to change. Software non-returnable. 20% restocking on non-MultiRam approved returns. Ramworks/TimeMaster/Z-RAM/gS-RAM trademarks of Applied Engineering.

COIT VALLEY COMPUTERS 14055 Waterfall Way
(214) 234-5047 Dallas, Texas 75240

CIRCLE 105 ON READER SERVICE CARD

LETTERS

MODEM MGR SHOULD BE A STAR

Dear A+: I thoroughly enjoyed reading the December 1987 issue of A+, with its special All-Stars coverage. I believe the Apple community should be made aware of the finest software products that are available.

There was one program that should have made the telecommunications list in my opinion: Modem MGR by James H. Okubo. I am strictly a user and not a telecommunications-program expert; I would, however, like to inform you and your readers of the support I have received after purchasing this program.

At first, Modem MGR did not work with my Rixon modem. When I informed the author of this problem, he immediately called Case Communication and programmed the necessary information to resolve this compatibility problem. I considered this alone to be a first-class support effort.

Approximately four months later, I began a subscription to a commodity data-retrieval service. This service provided a special software package for downloading prices. Unfortunately, I ran into the same compatibility problem with my Rixon modem. I called the data-retrieval company for assistance, but no one there was able to resolve the problem.

As a last resort, I wrote to James Okubo for help. Within a week, I received the data-retrieval program back from Okubo, and it was now totally compatible with my modem. I got all this support free with the purchase of the original Modem MGR program.

I have never received this type of support from the so-called national software companies. You didn't include Modem MGR in your top 96, but if you'd had a special category for authors or companies that provided the best support, James H. Okubo would have to have been on top of that list.

BRUCE W. THOMPSON
 SCHAUMBURG, IL

LASER 128EX

WHEN YOU FEEL THE NEED FOR SPEED



The Laser 128EX is 3 times faster than an Apple IIe or //c.

The Laser 128EX Apple-compatible computer has all the built-in features of the popular Laser 128, plus more. MORE FEATURES, MORE MEMORY, MORE SPEED AND MORE EXPANDABILITY. The Laser 128EX is designed for the serious computer user, and it's ready-to-run — plug it in, insert your program and take-off. This machine is built to race.

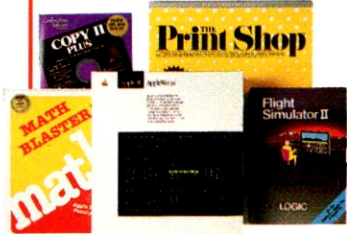

Speed through the largest software library in the world.

The Laser 128EX runs Apple IIe and //c software at speeds never before achieved. Its built-in 192K RAM (128K — User and 64K — Video) memory and triple speed processor lets you run programs at a world class pace. The Laser 128EX is a machine designed for leading performance.

The 128EX has everything built-in, including a disk drive and interfaces to all your peripherals, including

serial and parallel printers, a modem and mouse, joysticks, external 3½" and 5¼" drives, and even a color RGB or monochrome monitor. Only the Laser 128EX has these performance features built-in.

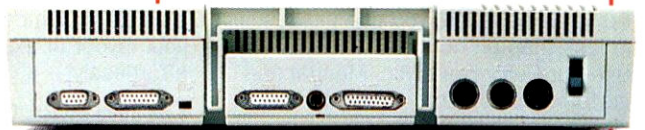

The Laser 128EX is expandable!

Boost the internal memory of the 128EX over 1Mb with its fully socketed AppleWorks-compatible RAM board. And, it has an expansion slot to let the computer grow with your increasing demands.

The Laser 128EX performs like a top-of-the-line Apple, but is priced like a Commodore. The 128EX is

about half the price of an Apple //c with three times the performing power. **For more information on the Laser 128EX and the name of your nearest dealer, call Central Point Software at 503/244-5782,**

8 - 5, M - F. Or order the

128EX direct from

Central Point at 9700 SW Capitol

Highway, Portland,

OR 97219. VISA/

MC/CASHIER'S

CHECK add

\$20 shipping

& handling.

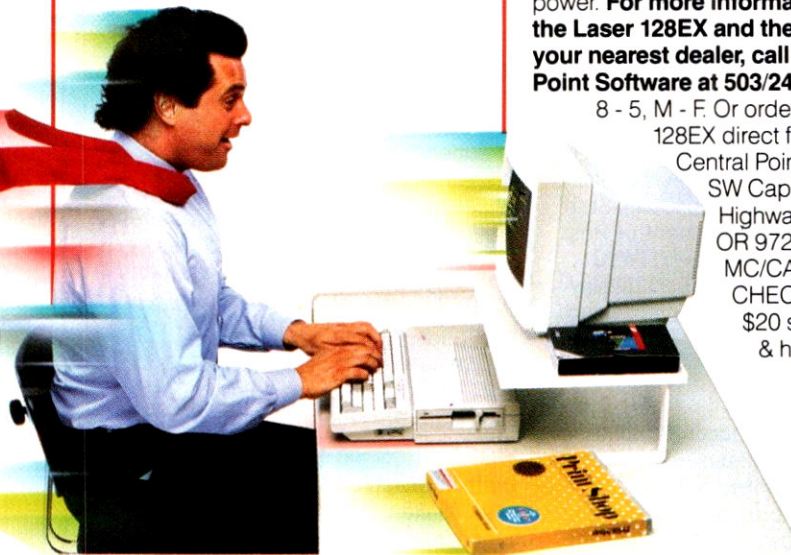

LASER 128EX

Apple, Apple IIe and Apple //c are registered trademarks of Apple Computer, Inc. Commodore is a registered trademark of Commodore Business Machines, Inc. ©1987

Central Point Software, Inc.

THE AFFORDABLE COMPUTER-\$499

CIRCLE 107 ON READER SERVICE CARD

With Timeworks You Get:
 • Free Customer Technical Support
 • A Money Back Guarantee

Publish It! in less than an hour

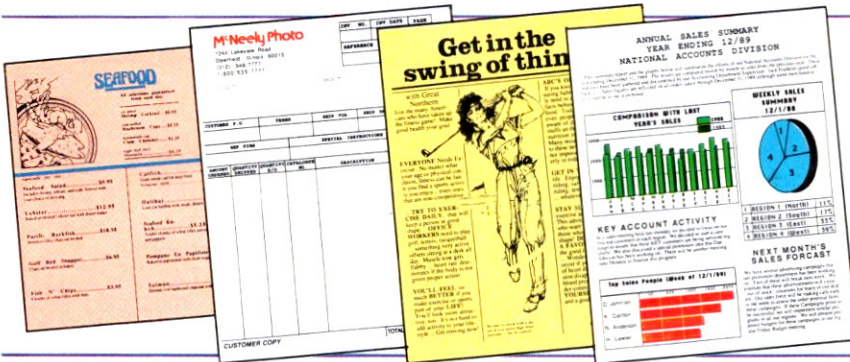

Introducing **PUBLISH IT!** A full-featured, fully integrated desktop publishing powerhouse with word processing, page layout, and graphics.

Even if you have no design skills or publishing experience, you can get results in less than an hour with **PUBLISH IT!** Use our Quick-Start Mini-Manual and go to press. It's that simple.

Your computer display shows you *exactly* how your finished documents will look. Use the program's built-in layout tools to reposition and resize elements on the page. Once it's perfect, just press a key and print out on your dot matrix or laser printer.*

For all its state-of-the-art ability, **PUBLISH IT!** is incredibly easy to learn—refreshingly so. **PUBLISH IT!** combines the familiar Macintosh User Interface, our Quick-Start Mini-Manual, a full complement of Help Screens, and the practical **WYSIWYG (What-You-See-Is-What-You-Get)** display—all designed to get you up and running in less than one hour!

SPECIAL FEATURES:

- **Macintosh User Interface:** It's familiar and easy. Pull-down menus, icons, scroll bars and dialogue boxes help you learn and use the program quickly. Your display screen shows you exactly what your final product will look like when you print—What-You-See-Is-What-You-Get.
- **Flexible Page Layout:** With your mouse or joystick, and keyboard, you can

overlap, reposition, resize, and reshape the text, columns, graphics. Change your layout or experiment—almost effortlessly!

- **Built-in Fonts:** Choose from more than 1280 possible type-style combinations! Opt for bold, italic, underlined, outlined, shadow, and superscript or subscript characters. Select your effect with ease! Type sizes range from 9 point to 72 point.
- **Premium Quality Printouts:** **PUBLISH IT!** uses a special high density (72 x 120) printout format that gives you superior quality printouts on your dot matrix printer.
- **Built-in Word Processor:** All the features necessary for everyday word processing, plus most of the sophisticated ones found only in more expensive programs.
- **Text Importing:** Load documents from APPLEWORKS, BANK STREET WRITER** or any other word processor in standard ASCII format directly into **PUBLISH IT!**
- **Built-in Graphic Toolbox:** Draw lines, boxes, circles, rules and more. Plus, choose from a wide variety of built-in line and fill patterns, or create your own.
- **Graphics Importing:** Directly import graphics and illustrations from any standard Apple** double-high-resolution drawing program—including

ing Broderbund's DAZZLE DRAW**. Then crop and size them to fit.

- **Special Typesetting Functions:** Kerning, leading, and more! Add professional finishing touches that make your message stand out.
- **Automatic Text Flow and Word Wrap:** **PUBLISH IT!** automatically flows text from column to column on the same page, or carries it over to subsequent pages.
- **Multiple Size Page Views:** View, edit and layout pages at actual, double or half-size. Or, reduce them so the entire page fills the screen.
- **Over 200 Professionally Drawn Graphics & Illustrations:** Ready-to-go art makes your documents even more eye-catching.
- **Plus, you get worksheets, time-saving features, sample documents & more!**

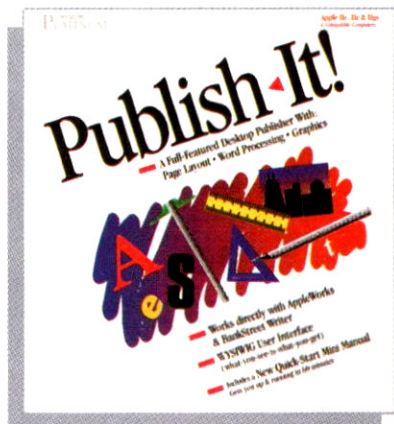

Start publishing in less than an hour—at a price you can afford! **PUBLISH IT!** retails for just **\$99.95**.

Find it at your local dealer or order direct from Timeworks—call:

312/948-9202



444 Lake Cook Rd., Deerfield, IL 60015
 312/948-9202

*Laser Printer requires Timeworks Accessory Pak. Details inside package. **Registered trademarks of their respective companies.

©1987 Timeworks, Inc. All rights reserved.

BY LISA RALEIGH AND ALANE BOWLING

NEWS PLUS

Apple tours with MTV, NAUG offers free AppleWorks advice, mail-order companies aim for better image, and other industry updates

APPLE AND EMPTY-V

Apple Computer, Inc., has become a mall rat, hanging out with the heroes of mall-ratdom, the folks from MTV. But don't look for Apple representatives to be acting like rude dudes in acid-washed jeans and buzz-cuts. Instead, conventionally attired Apple

folks are participating in a nationwide mall tour called MTV's Museum of UnNatural History, featuring interactive displays of music, fashion, and technology. For its part, Apple will be showing how you can use the Apple IIGs and the Mac with Apple's new MIDI box to create righteous tunes, as well as how Apples can be used for truly unnatural stuff—such as

productivity and education. The tour will hit 27 cities by mid-September. Catch it soon at a mall near you.

APPLEWORKS HELP LINES

Now that Claris Corporation has opened a telephone-support line, there's a ready source of assistance for AppleWorks users. That number, in case you missed it in our April issue, is (415) 962-0371. But perhaps you're unwilling to make that long-distance call to connect with Claris in California. If so, the National AppleWorks User Group has an alternative. As a service to its membership, NAUG identifies members from all over the country (and Canada and Mexico as well) who are willing to offer free AppleWorks help over the phone to other members. NAUG asks the volunteer helpers to identify the areas in which they're most expert (e.g., educational applications, add-on applications, and the like) and publishes a chart in its newsletter showing who's able to help with what and how to get in touch with them. For further information, contact NAUG, P.O. Box 87453, Canton, MI 48187; (313) 397-1594. The annual membership fee is \$24.



New!

STEREO CHART™

A six-disk powerhouse for the Apple II+, IIe, IIc, IIGS, Laser 128, and Franklin.

97 elegant chart styles in standard two dimensions or in eye-popping stereoscopic 3D! STEREOCHART supports 63 different printers. It's ready for instant use. No other programs or hardware required. Spreadsheets are not required. It's extremely simple data entry and user friendliness makes it perfect for home, school, or business.

YEARLY CASH RESERVE

1983

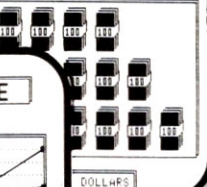

HIGH-LOW-CLOSE

DOLLARS

210
209
208

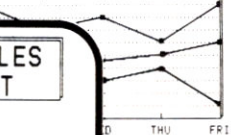

COMPANY SALES IN PERCENT



■ BARNES
■ SMITH

ABCD1234 ABCD1234
ABCD1234 ABCDE12345
abcd ABC123 ABC1234
ABC1234 ABC1234
abcd ABC1234
ABCDE1234

STEREOCHART creates horizontal and vertical bar charts, pie charts, scatter, area, trend and mathematical function charts.

COMPUTER SALES

NUMBER

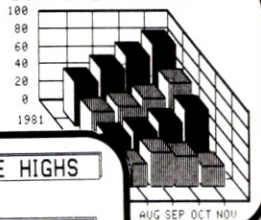

TEMPERATURE HIGHS

DEGREES

110
109
108
107



FOREIGN AUTO SALES

NUMBER SOLD

100000
80000
60000
40000
20000



■ HONDA

SALES PERFORMANCE

NUMBER SOLD

100
80
60
40
20
0

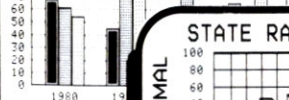

■ SMITH

STATE RAINFALL

% OF NORMAL

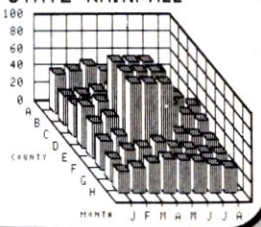

Add extra art to your chart with STEREOCHART's free-hand drawing program, with push-button creation of lines, boxes, circles and icons.

STEREOCHART also creates unique symbol charts with our library of 84 pre-drawn icons (or design your own).

STEREOCHART'S special text-typing program lets you add to your charts extra titles, labels, or any text whatever, anywhere you wish. Or, make view-graphs, signs, certificates, and ads. In 24 different letter styles and sizes.

ONLY \$69.95

VISA/MASTERCARD/C.O.D./CHECK

Order by phone or mail. Mon-Fri, 8am-6pm. Sat 8am-12pm. PDT

Orders only, Toll Free **1-800-826-2989**

Orders only, California **1-800-231-7316**

Or call now for \$3.00 demo disk which shows it all.

SPECTRAL GRAPHICS SOFTWARE

6333 Pacific Ave. • Stockton, CA 95207 • 1-209-473-2862

CIRCLE 255 ON READER SERVICE CARD

NEWSPLUS



YOU ARE THERE

As Buckaroo Bonzai says, "Wherever you go, there you are." And if you happen to take along an InfoCom game and a camera, you might receive fame (but not fortune) in InfoCom's newsletter, *The Status Line* (formerly *The New York Times*.) Here's the offer: The next time you visit a famous landmark, take a picture of yourself holding an InfoCom game and send it off to InfoCom. The company will then publish the best photos.

Actually, there might be fortune involved for one lucky traveler. The first person to send a self-and-game portrait from the Great Wall of China will receive a complete catalog of InfoCom games. Entries go to: Landmark Photo, InfoCom, Inc., 125 Cambridge Park Drive, Cambridge, MA 02140.

MAIL-ORDER ETHICS

If you've heard horror stories about buying computer products via mail order, you're not alone. Buying direct from the manufacturer or through a mail-order house can mean great prices, but it can also create headaches.

Aware that consumers are concerned about the performance of direct-marketing organizations, a group of such companies has formed the Micro Marketing Council. The purpose of the council is to improve the image of direct marketers by providing ethical guidelines, professional development, and consumer education. Members promise to state their sales policies in their ads and to charge customers' credit cards only once they've shipped the product.

Among the 19 compa-

ILLUSTRATION BY MAX SEABAUGH

A disk each month delivered to you... packed with eight programs for your Apple.

DISCOVER UPTIME. You deserve the best from your Apple. Have the best and save the most with UPTIME.

We make it easy and inexpensive — a disk each month. You deserve value. At UPTIME we believe in value. That's why each month 21,000 people like you enjoy a disk packed full of programs and information.

Make your life easier & get more from your computer. Organize your life and be more productive with **home management** and **finance** programs. Have fun learning with our **educational** programs and fun relaxing with **games** and **adventures**. You'll find **business, graphics, utilities** & more!

Ten programs and more on every disk. What's the opposite of "downtime"? It's UPTIME, of course. Just imagine... a disk each and every month, delivered right to your door and packed with programs for your Apple.

Subscribe now, with our introductory offer! Make the very next disk yours! Fill in the coupon and return it to us, or simply call. We'll start your subscription immediately, in addition to sending you...

**17
FREE
PROGRAMS**

Put work gloves on your Apple with **UTILITY TIME** — 17 programs including *Banner Maker*, *Musical Keys* and *Graphix Fun*. For **immediate service**, call toll-free: **1-800-437-0033** anytime, day or night.

**LESS THAN
60¢ PER
PROGRAM**



NOW
FOR ALL
APPLE II
COMPUTERS

A Typical Disk Includes:

- Puzzle Time · Playing the Market · Zippi Zombi
- College Bound · Spellpruf · Graf Edit
- Electronic Jukebox · Spell Evasion

Look for us in Waldenbooks, B. Dalton and other book and computer stores in your area.

**I'LL BYTE!!!
SAVE 60% → 12**

I'm an Apple enthusiast who wants more. Please start my subscription to UPTIME immediately.

6 Disk Issues \$69.95
 3 Disk Issues \$29.95
 1 Disk Issue \$11.95

Name _____
 Address _____
 City _____ State _____ Zip _____
 Bill my: Visa MC Exp. Date _____
 Signature _____ Account No. _____

(Add \$2 per issue in foreign countries, except Canada and APO)

Please send my **FREE Utility Time** disk (\$18.45 value)
 Payment enclosed. (Make checks payable to UPTIME.)

Send to:
UPTIME · PO Box 299
 Newport, RI 02840
 (401) 849-4925
 A05

New! RAMUP 4.0

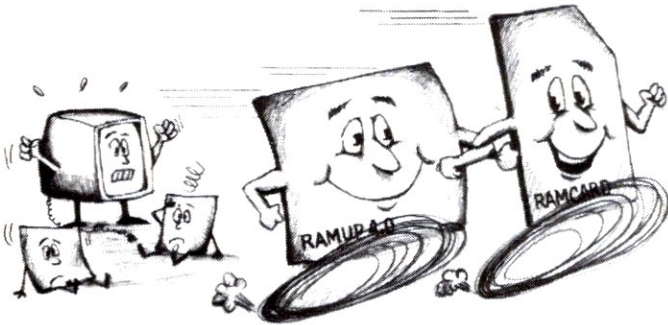

For speed and manageability nothing beats RAMUP 4.0 with your RamCard

Speed and manageability. All computer users want it. Few have it. With the new RAMUP 4.0, speed and manageability are just a key stroke away. RAMUP 4.0 is utility software that combines all your favorite programs onto your Apple compatible RamCard to make them act as one program. Now, changing programs is as easy as turning a page. No more disk swapping. No more waiting. You just flip from program to program at will. That's speed and manageability. That's RAMUP 4.0.

NEW FEATURES

- Autoload
- Back-up/Restore
- 200% Faster

PERFECT FOR

- IIGs — Ramkeeper, GS Ram; IIE - RamWorks, RamFactor; IIC — Z Ram.

YOU DON'T HAVE A RAMCARD?

Call us. We have the right RamCard for you. And, we'll show you how to combine your RamCard with RAMUP 4.0 for instant access to all your programs.

TRY IT! YOU'LL LIKE IT!

Not convinced? Try us out for 30 days. If RAMUP 4.0 with your RamCard doesn't significantly increase your productivity, simply return it for a quick and courteous refund.

RAMUP 4.0 and all RamCards are in stock and ready to ship. And, with your purchase, you'll receive, free, *Enhance*, our technical, informative, entertaining newsletter.

AE APPLIED ENGINEERING™
The Apple enhancement experts

RAMUP \$39.95

Transwarp.....	\$169.00	Phasor	Call
RamKeeper.....	148.00	Parallel Pro	79.00
RamCharger.....	136.00	Time Master	79.00
Serial Pro.....	114.00	View Master	109.00
Data Link.....	172.00	PC Transporter	Call

RamWorks III	Call
RamFactor.....	Call
GS Ram	Call
GS Ram +	Call
Z Ram I, II, III.....	Call

Due to fluctuating conditions in the Ram Chip market, we are unable to print current prices. Please call us, toll free, for fair, honest prices and same day shipment. We guarantee the lowest available prices.

PRICES SUBJECT TO CHANGE



Quality Computers

POWER FOR PERFORMANCE

15102 Charlevoix
Grosse Pointe, MI 48230
313/331-0700

To Order Call: 1-800-443-6697

CIRCLE 204 ON READER SERVICE CARD

NEWSPLUS

nies forming the council are at least two that are active in the Apple II market: JDR Micro-devices and Jameco Electronics. For a list of other direct marketers, contact John Irvine, John Irvine & Associates, 200 North Tustin Avenue, #100, Santa Ana, CA 92705; (714) 953-9449.

SOFTWARE FOR LIFE

Plenty of IIGs owners are disgruntled. They've found that if they want to move up to software designed especially for the GS's features, they must pay the full price for GS versions, even if they already own the IIE/IIC release. If they've been a loyal customer and made the investment in an 8-bit version, why shouldn't they get a break on the 16-bit release? The answer depends on which software company you talk to.

Electronic Arts has instituted a software-exchange program called Software for Life that lets you turn in the manual cover of your 8-bit EA program and then get the 16-bit version for half the retail price. EA isn't restricting you to any brand of computer, so you don't necessarily have to be going from the 8-bit IIE/IIC to the 16-bit GS. You can also get the same bennies moving up from another 8-bitter such as the Commodore 64 or the Atari 800.

CLUB MECC

MECC (Minnesota Educational Computing Corporation) has introduced the MECC Home Software Club, which gives members discounts on MECC's line of educational software. The major advantage to joining this club, though, is that it gives home buyers easy access to MECC's highly touted software, which is primarily sold directly to schools. To join the club, you pay \$75 and get four MECC titles (worth \$120) and a 10% discount on future purchases. Just as in a book or record club, this club offers a featured title every other month, which you can choose to receive or not. For further details, contact the MECC Home Software Club at 3490 Lexington Avenue North, St. Paul, MN 55126; (800) 228-3504.

ALL THE NEWS THAT'S FIT TO PUBLISH

Desktop publishing on the Apple II now has its own newsletter, the *Desktop Publishing Newsletter*. Yearly subscriptions cost \$20 for this 16-page bimonthly, which will offer hardware and software reviews and tips and techniques. It's published by Sage Productions, 5677 Oberlin Drive, San Diego, CA 92121; (619) 455-7513.

NEWS PLUS

UPDATE

■ Last year it was Kroy Color. This year it's Kroy Color Plus, the new color-transfer system from Kroy, Inc., that adds color to documents produced on laser printers including the Apple LaserWriter and H-P LaserJet. The Kroy Color Plus enables laser-printer users to add color to text or graphics. You place a laser-printed page between color-transfer sheets and pass them through the color processor. The color bonds to the toner image in less than 30 seconds. More than 50 colors of transfer film are available, including 14 metallic foils. The Kroy color-transfer film costs about \$60 per carton. The Color Plus processor itself is priced at \$875. For more information or to order, contact Kroy at (800) 328-1306 or (602) 948-2222.

■ There was more going on in Canada last winter than the Olympic Games. In January, Logo Computer Systems, Inc. (LCSI), of Montreal made available a ProDOS version of its word-processing and graphics product LogoWriter. The LogoWriter ProDOS version requires 128K of RAM and lets you convert ProDOS text or graphics files, including Apple II files, into LogoWriter pages that

ProDOS word-processing and telecommunications software can access. This new version also works with the Corvus, Nestar, and VELAN Classroom networks. LogoWriter's ProDOS version is available through LCSI's site-licensing program. The price of the Apple ProDOS extension for current licensees is \$35. For newcomers, the one-time site-license fee is \$450. For more information or to order, contact LCSI at (800) 321-LOGO.

■ Micromatics, Inc., maker of Math Teacher's Tool Kit, which we reviewed in our March issue, has informed *A+* that it inadvertently supplied the reviewer with its bulk-purchase—instead of single-sale—prices. The firm did honor the bulk-purchase prices (for 25 sets or more) for single sales through April 1. The correct single-sale prices are \$40 per disk and \$100 for a set of three.

■ In preparing the printer-compatibility chart for printer-interface cards in the March *A+*, we did not have access to Applied Engineering's new manual for the Serial Pro. As that manual clearly indicates, the Serial Pro works with the Apple ImageWriter, Epson, NEC 8023, Anadex, IDS, Okidata 84 and Mannesmann-Tally printers. +

New! EasyDrive™

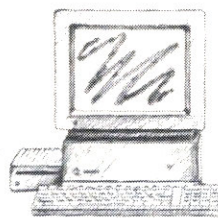

If you have this . . .

. . . and this

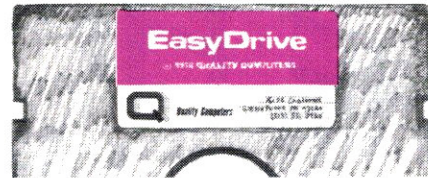
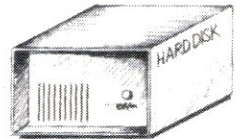

. . . you need this

EasyDrive is, simply, the most important breakthrough in hard-disk technology — ever. It's the first and only complete software interface for the hard-disk (for Apple IIe, IIs and compatibles). Nothing else is faster or easier. With EasyDrive you get:

- Complete control of all hard-disk operations
- Automatic installation
- Automatic loading
- Menu-driven simplicity
- Fast, accurate back-up and restore operations
- File indexing
- Complete statistical display
- ProDOS compatibility
- Plus much more!

And, EasyDrive is expandable and upgradeable. When we add features, you get them, too. Only EasyDrive gives you all of this. Only EasyDrive gives you complete control. If you have a hard-disk, you need EasyDrive.

FREE! FREE! FREE!

With your purchase of EasyDrive, you'll receive the book "Setting Up Your Hard-Disk with ProDOS 8 & 16", the definitive manual of hard-disk use and maintenance — a \$19.95 value, free from Quality Computers.

TAKE A TEST DRIVE ON US!

Too good to be true? Try us out for 30 days. If EasyDrive doesn't make your hard-disk work faster and easier, just return it for a quick and courteous refund. You can keep the free book.

Quality Computers also carries a full line of hard-disks from top manufacturers like CMS and Sider, all with a 30 day money back guarantee.

EasyDrive — \$69.95

SIDER		CMS	
20 Meg.	\$549.00	20 Meg. SD	\$579.00
40 Meg.	Call	40 Meg. SD	879.00
C46	Call	60 Meg. SD	949.00
C96	Call	SCSI Controller	95.00

PRICES SUBJECT TO CHANGE



Quality Computers

POWER FOR PERFORMANCE

15102 Charlevoix
Grosse Pointe, MI 48230
313/331-0700

To Order Call: 1-800-443-6697

CIRCLE 209 ON READER SERVICE CARD

*What it is, how it works,
and why you might need it*

THE APPLE II NETWORK

Just over three years ago, in January 1985, Apple Computer, Inc. introduced the world to the AppleTalk Personal Network, later renamed the AppleTalk Network System. At that time, AppleTalk was simply the means by which several Macintoshes, wired together like links in a chain, could share an expensive LaserWriter printer. AppleTalk became even more useful in January 1987, when Apple released a program called AppleShare, which allowed Macintoshes to share files on a hard-disk drive connected to a specially configured Mac called a file server. Apple now sells products that permit MS-DOS computers to work with AppleTalk-compatible printers and file servers as well.

Last March, Apple finally revealed that it would start selling a suite of hardware and software products this summer that would allow an enhanced 128K Apple IIe and a 512K IIGS to be part of an AppleTalk network. Apple has no way to network the IIc and II Plus, nor is it working on one.

The AppleTalk network is the most significant new "peripheral" Apple has released for the Apple II family in some time. In a nutshell, networking can do away with the costly duplication of peripherals in the classroom and in small-business work groups and will lead to the development of software that can help make networked groups become very productive. This article will focus on the AppleTalk

network—what it is, how to set it up, and how to decide if you're ready to take the plunge. You'll also find many other articles in this issue discussing networking issues and other network brands.

Setting Up an AppleTalk Net

AppleTalk is nothing more than a set of communications protocols, or rules, that devices on a network must utilize to send and receive packets of data through the net-

work instead of Printer Port. The result is that serial port 1 becomes the AppleTalk port.

The Apple IIe has no built-in AppleTalk port, so you need to add one by plugging in a new Apple II Workstation Card (see figure 1). You should plug the card into slot 7 if you want to be able to boot automatically from the network when you turn on the IIe. An adapter box connects to the card and provides a serial port for a directly connected printer and an AppleTalk port that behaves much like the one on the Apple IIGS.

(The ROM on the Apple II Workstation Card contains all the software that defines the AppleTalk communications protocols; the AppleTalk ROM in the Apple IIGS does not. To load the missing AppleTalk routines into a IIGS, you must boot a new version of the Pro-

Figure 1: Apple II Workstation Card

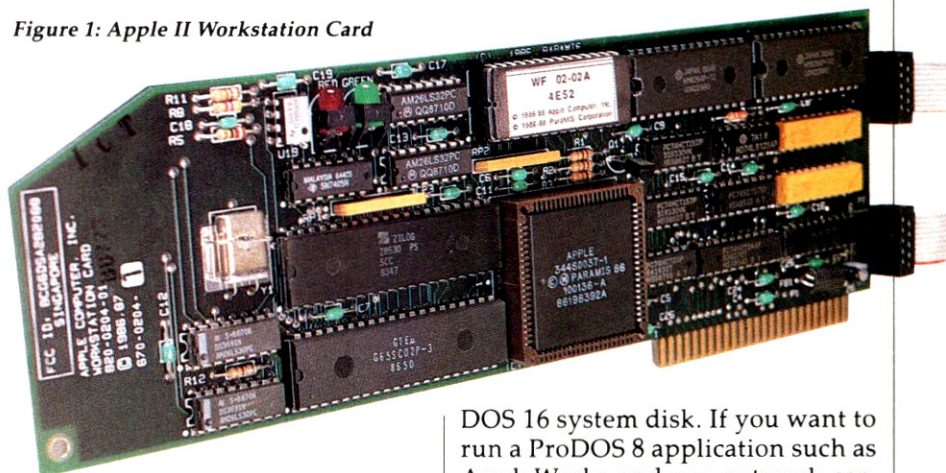

work medium. The most common AppleTalk medium is Apple's LocalTalk cable, although you can use other types of media as well (see "Buzzwords" on page 32 for definitions of AppleTalk terms).

Each device you want to connect to an AppleTalk network must have an AppleTalk port. Macintoshes, LaserWriters, and the Apple IIGS all have built-in AppleTalk ports. To activate the AppleTalk port on a GS, you use the Slots command on the Control Panel to change the slot 7 option to Built-in AppleTalk instead of Your Card. Then you change the slot 1 option to Your

DOS 16 system disk. If you want to run a ProDOS 8 application such as AppleWorks and use network services as well, you must first boot ProDOS 16 and then select the application from the ProDOS 16 Finder or Launcher.)

You can also buy AppleTalk-port interface cards for ImageWriter II printers and MS-DOS computers.

For each device you want to connect to the network, you need a LocalTalk Connector Kit. The kit includes a LocalTalk connection box with a short drop cable for connecting to the device's AppleTalk port (see figure 2). It also comes with a two-meter LocalTalk cable for joining the connection box to the next box in the chain of network de-

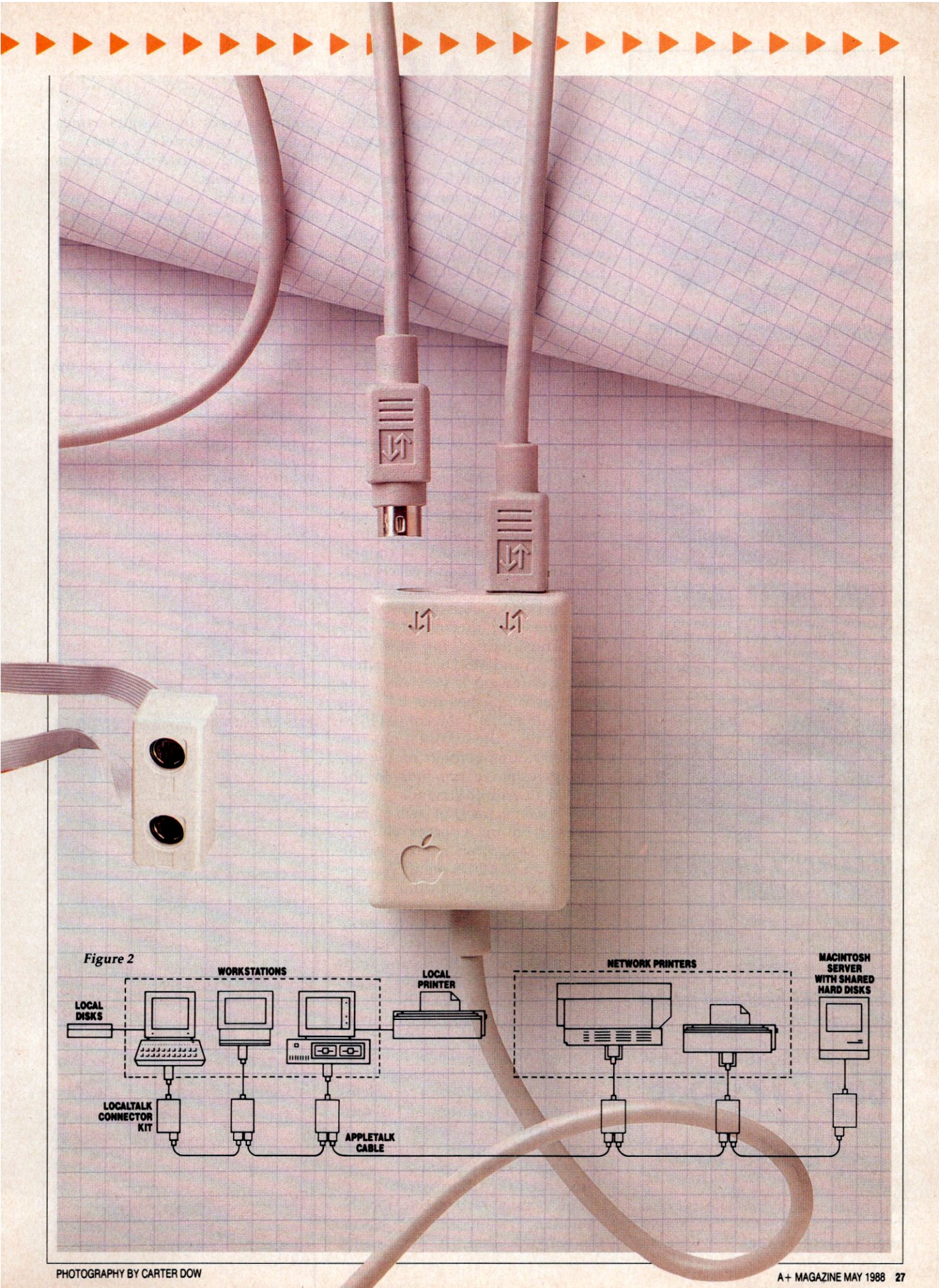
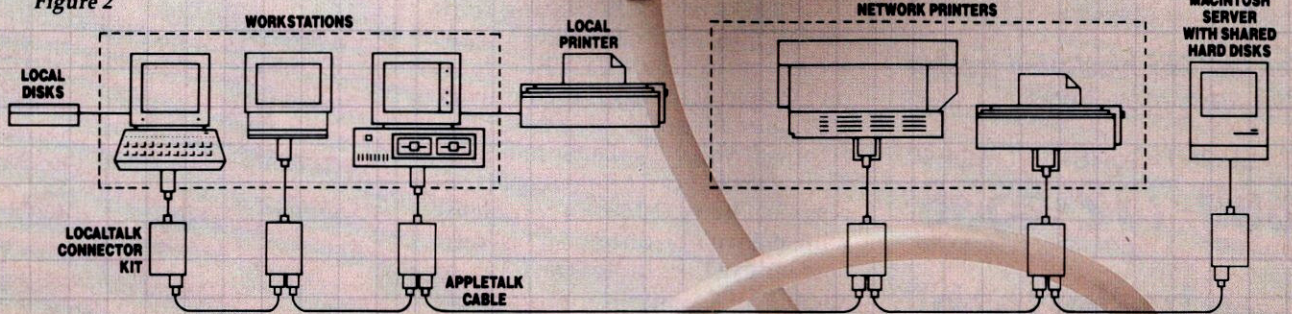

Figure 2



▶▶▶▶▶ NETWORK ▶▶▶▶▶



\$-SAVING RIBBON INKERS

Now you can re-ink fabric ribbons again and again! This product pays for itself. FREE 4-oz. of black ink.

IMAGEWRITER PRINTER INKER \$49.00
EPSON PRINTER INKER \$52.95



\$29.95 PRINTER SILENCER

Reduce irritating printer noise up to 90%! Attractive wood grain finish, 200 lb. test corrugated cdb. Ideal for light and medium use of printers up to 17.5" x 13" x 5.5".

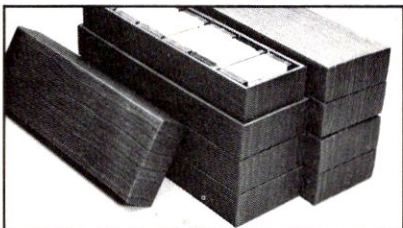

HI-CAPACITY, LOW-COST DISK ORGANIZERS

Hi-gloss white or wood grain finish. Sturdy 200 lb. test corrugated cdb. Styles hold 50 or 100 disks—5 1/4", 3 1/2" or C.D. Priced \$3.49-\$7.45

Call for **FREE illustrated catalog** with many more items.

CALL 24 HOURS TO ORDER
800-772-4536
IN OHIO 216-631-4214 • FAX 216-631-1452

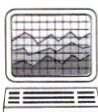

bede tech™
Division, Bede Industries, Inc.
Established 1976 A5
8327 Clinton Rd. • Cleveland, OH 44144

CIRCLE 244 ON READER SERVICE CARD

vices. You can connect up to 32 devices in this way to form a single AppleTalk network.

The AppleShare File Server

Apple's file-server software is called AppleShare (see figure 3). The new version, 2.0, now works with Apple II ProDOS as well as the Mac and MS-DOS operating systems. Keep in mind, however, that AppleShare runs only on a Macintosh, so an all-Apple-II AppleTalk network is not possible if you need access to a file server—you will need a Macintosh to run the server. (You may, however, have an all-Apple II network if you simply want to share network printers.)

AppleShare manages the disk volumes that are connected to the Mac (usually large hard disks) and makes them available to all computers on the network. Although files are stored in the Macintosh format, Apple II computers see them as ProDOS files, and MS-DOS computers see them as MS-DOS files. Thus, exchanging files with Macintosh and MS-DOS computers over the network is very easy. The server accomplishes this by using the Apple Filing Protocol (AFP) to manage files; the workstations run translators that convert native operating-system commands to the equivalent AFP commands.

AFP keeps track of two names for each file on a server volume. One is a Macintosh name, and the other is an MS-DOS name. An Apple II workstation running a conventional ProDOS application can use files on the server only if the Macintosh name is also a valid ProDOS name. (ProDOS naming rules are far more restrictive than Macintosh naming rules.) Therefore, non-Apple-II users on the network must give files and folders (subdirectories) valid ProDOS names if they want to give Apple II users access to them. Naming problems will eventually disappear as software developers learn how to adapt ProDOS applications to handle Macintosh-style names.

The Network Administrator

The person responsible for the smooth operation of the file server, the network administrator, defines

groups of users and assigns names and passwords to network users so they can log onto AppleShare as registered users.

You don't have to log on with a name and a password, but you'll want to so you can control how other users may access the folders and files you've put onto the server. If you log on as a guest (i.e., without specifying a user name and password), you cannot restrict access at all.

The administrator also sets up

Figure 3: The AppleShare software on the Macintosh server presents you with a status screen showing network activity. AppleShare software also lets network administrators change access attributes, create user and group lists, and assign a startup application, prefix, and printer for each Apple II network user.

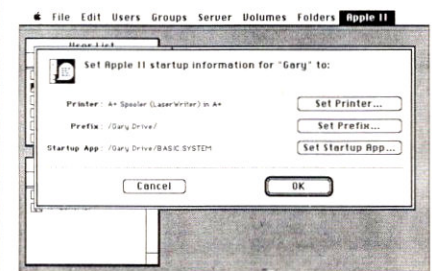
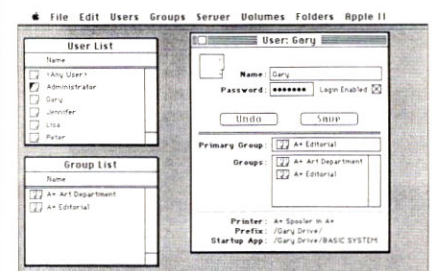
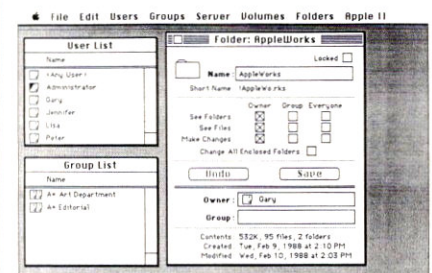
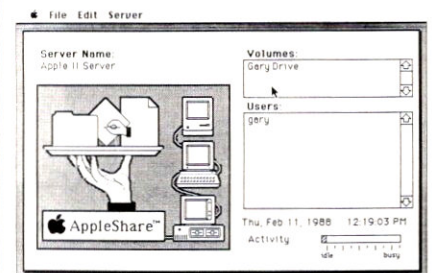

Global communications. Down-to-earth price.

\$219

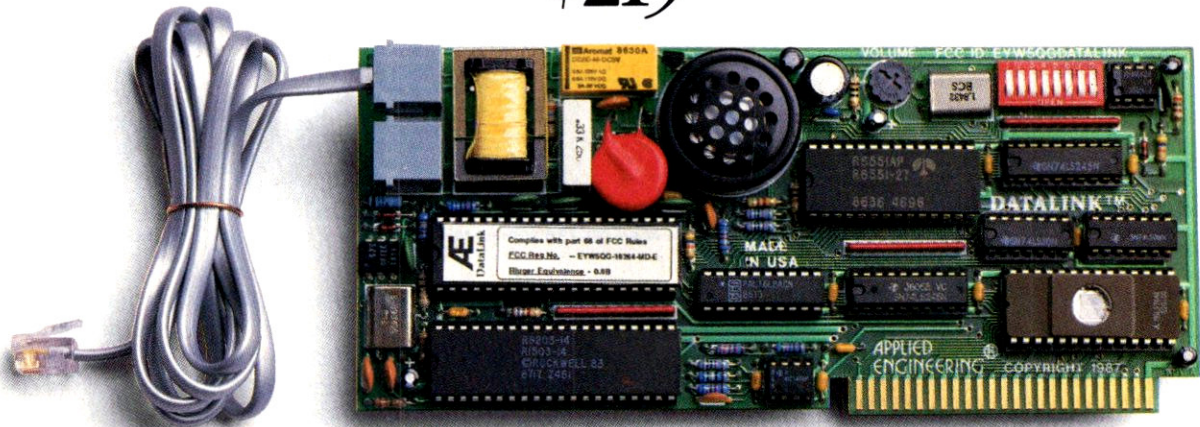

Introducing the DataLink™ modem.
Get instant access to networks and databases
— plus network memberships and discounts worth \$177.95!

Now you can tap into a world of information — without draining your resources. Our DataLink™ modem lets your Apple IIGS, IIe or II+ communicate with other computers, download free software from networks and bulletin boards, access database services and more. For a remarkably low price.

The world at your fingertips.

With the DataLink modem, you'll be able to draw information from thousands of databases. Send and receive electronic mail — even overseas. Join clubs and bulletin boards to exchange software or solve computing problems with other Apple users. Download free public domain software. And share files with personal computers and mainframes.

There's nothing missing on DataLink.

Unlike the Smartmodem®, DataLink comes with its own easy-to-use communications software in ROM and on disk that supports macros, file transfers, on-line time display, data capture and datascopes mode. The software also allows you to store hundreds of phone numbers for auto dialing and log on.

Because DataLink is 100% Super Serial Card compatible, you can also run virtually all other communication software, including Point-to-Point, Apple Access and ASCII Express, to name a few.

The compact design allows DataLink to fit in any slot — including slots 1 and 2 of the IIGS with a cooling fan installed. DataLink operates at 1200 or 300 baud. Built-in diagnostics check for accuracy of data transmission, and DataLink lets you track the progress of calls either electronically or via an on-board speaker.

Introductory offers from popular networks included.

When you purchase DataLink, you'll get a fee-waived membership to The Source worth \$49.95. \$60.00 worth of free on-line time from NewsNet. A free \$50.00 subscription to the Official Airline Guide. And a free subscription to the GENie network worth \$18.00!

	Applied Engineering DataLink	Hayes® Smartmodem 1200A
Price	\$219	\$349
Max. transmission rate	1200 baud	1200 baud
Warranty period	5 years at no charge	2 years or 4 years for \$75
Software included	YES	NO
Hayes AT command set	YES	YES
Help screens	YES	NO
On-board telephone jacks	YES	NO
Fits any slot (even with fan)	YES	NO

Smartmodem is a registered trademark of Hayes Micro Computer Products.

Order today!

To order or for more information, see your dealer or call Applied Engineering today, 9 a.m. to 11 p.m. 7 days. Or send check or money order to Applied Engineering. MasterCard, VISA and C.O.D. welcome. Texas residents add 6¼% sales tax. Add \$10.00 outside U.S.A.

AE Applied Engineering
The Apple enhancement experts.

P.O. Box 798, Carrollton, TX 75006
(214) 241-6060

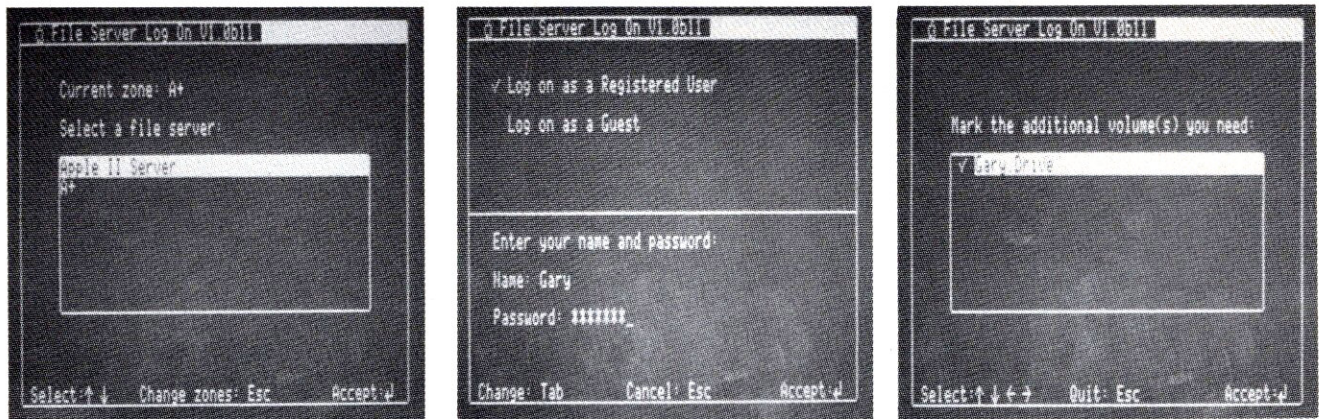

Figure 4: Logging onto AppleShare. The Logon program first asks for the server you want, then your name and password, and finally the server volumes you want to use.

which program will run when an Apple II user tries to boot from the network instead of from a local drive. Booting from the network is possible if you've previously put the necessary ProDOS system files onto the server. Any 128K enhanced Apple IIe can auto-boot from the network; if you have a GS, you need at least 768K of memory.

Accessing the Server

Before you can use an AppleShare disk volume from your Apple II workstation, you must run the Logon program on the ProDOS system disk. When Logon starts up, it scans the network for AFP file servers and displays a list of them on the screen. You then select the server you want to use, enter your user name and password (or specify guest access), and then select the server volumes you want to work with. (See figure 4.)

Thereafter, you can use the selected server volumes just as if they were on a disk directly connected to your II. You can create folders,

transfer programs and files to the server and back again, and so on.

Controlling Access to Folders

Although a file server is ideal for sharing files, you may want to prevent other users from seeing your files or changing them. AppleShare maintains three access-control attributes for each folder on the server, and the owner of the folder can adjust them to specify just who has the right to perform the following types of operations (see figure 5):

See Folders. Permits users to see the names of any folders within the current one.

See Files. Permits users to see the names of files inside the folder, read files, and copy files.

Make Changes. Permits users to move, change, and delete files inside the folder and add new files.

You can set these attributes for each of three user categories:

Owner. The person who created the folder or who was assigned ownership of the folder.

Group. Any group (set of users) the system administrator has previously set up.

Everyone. Any user with access to the server.

When a user first creates a folder, it is private. In other words, only the owner has the See Folders, See Files, and Make Changes privileges. You can use the ProDOS system program called Access to change the access attributes for Owner, Group, and Everyone.

Accessing Network Printers

More than one printer can be present on an AppleTalk network—you may have a LaserWriter for high-quality work and an ImageWriter II for draft work, for example. Thus, you must choose which printer you want to use before starting a print job, whether your file is on a IIe, IIGS, Macintosh, or IBM PC.

If you're printing from a IIe application program (which may be running on a GS in the Emulation mode), you choose a network

Figure 5: Changing access privileges. The Access program lets you adjust See Folders, See Files, and Make Changes attributes.

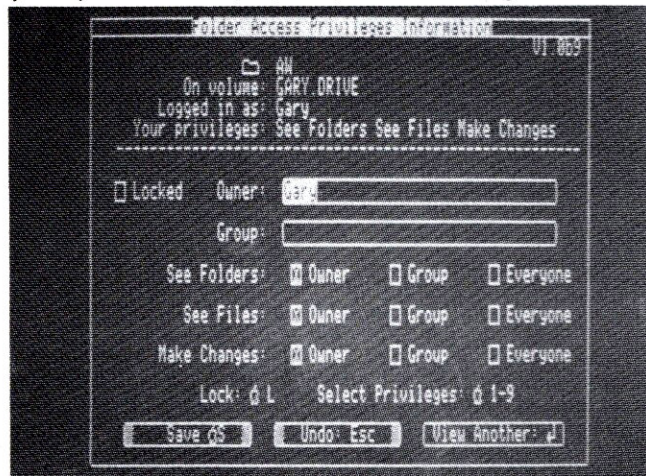
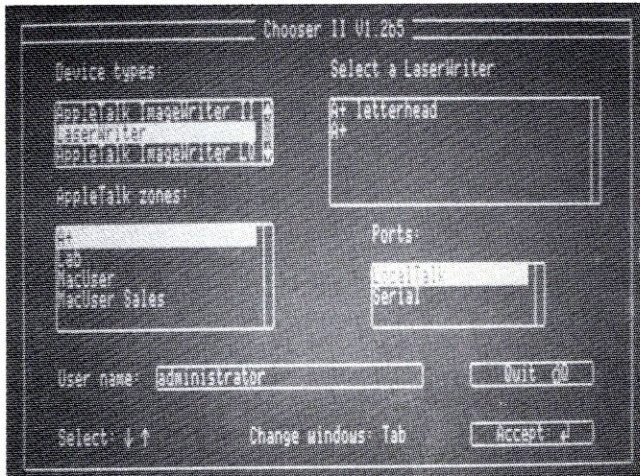
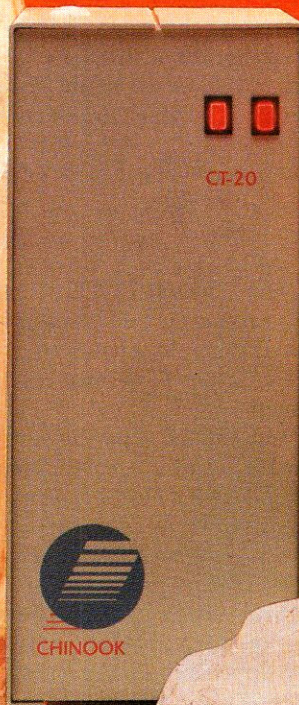

Figure 6: Choosing a printer. The Chooser.II program lets you select the network printer you want to use.



APPLE II OWNERS... YOU'VE BEEN OUT IN THE COLD TOO LONG



Announcing the CT-20 from Chinook Technology

For a while now, Apple II™ owners have been sort of, well, ignored. It seemed that all the exciting new products were developed for Macintosh™ systems rather than for Apple II's. Well, good news....those days are over. Now there's the CT-20 from Chinook Technology. Our 20 megabyte SCSI Winchester disk drive system was developed with only one thing in mind... you — the Apple II owner.

Quality and Cost

With the CT-20 you get a lot of one for a little of the other. We use disk drives known for their superior quality. We also include the system cable and SCSI adaptor card. And it gets better.

The CT-20 includes Easy Drive™ storage management software from Quality Computers. Quality hardware. Quality software. Quality system. There's just one more thing we should add — it doesn't amount to much — the price. Only \$650.

We Don't Leave You Out In The Cold

Our suppliers test each product extensively. Chinook then "burns in" each CT-20, checking all system functions. We are so confident in our testing procedures that we'll go one step further. Should you receive a system "dead on arrival", we'll ship another one out immediately, second day air, at no charge.

Also, don't confuse selling direct with abandoning the customer after the sale. We sell directly to you, the end user, because we strongly believe that we can support our system better than most dealers can. We offer toll-free technical support — just give us a call and we'll be there to answer any questions you may have.

We accept Visa/MC/AE/Personal check or Money Order. We offer a One Year Limited Warranty and a 30 Day Money-Back Guarantee.

To order your drive or for more information, write or call Chinook today.

CIRCLE 118 ON READER SERVICE CARD



Chinook Technology 601 Main Street #635 Longmont, Colorado 80501 1-800-727-5544 303-678-5544

Visit Us at AppleFest®!

Apple II and Macintosh are registered trademarks of Apple Computer, Inc. AppleFest is a registered service mark of Apple Computer, Inc. Easy Drive is a registered trademark of Quality Computer.

THE PERFECT PROMOTIONAL TOOL!

Quality reprints* of articles appearing in this magazine are available and will be custom designed to meet your special requirements.

For full details contact:
Jennifer Locke—
Reprints Manager,
Ziff-Davis Publishing
Company, One Park
Avenue, New York, NY
10016, 212-503-5447.

* Minimum quantity—500 reprints.

PROTECT YOUR COPIES OF A+ MAGAZINE

Make your collection of *A+ Magazine* a handsome addition to your office or home—and protect and organize your copies for easy reference!

A+ Magazine Binders and Cases are made of durable, luxury-look leatherette over quality binder board. Custom designed for *A+ Magazine*, every order receives FREE transfer foil to mark dates and volume numbers.

FOR FAST SERVICE CALL TOLL-FREE 1-800-972-5858

MAGAZINE BINDERS

Hold your issues on individual snap-on rods. \$9.95 each; 3 for \$27.95; 6 for \$52.95.

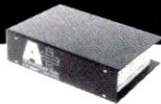

OPEN BACK CASES

Store your copies for individual reference. \$7.95 each; 3 for \$21.95; 6 for \$39.95.



A+ MAGAZINE

c/o Jesse Jones Industries
499 E. Erie Ave. · Philadelphia, PA 19134

Please send Binders Cases Quantity _____

Payment enclosed \$_____. * Add \$1 per case/binder for postage & handling. (Outside USA, add \$2.50 per case/binder ordered, US currency only.)

Charge my: Amex Visa MC (Minimum order \$15.)

Card No. _____ Exp. Date _____

Mr./Mrs./Ms. _____
Please Print Full Name

Address _____
No P.O. Box Number Please

City _____

State _____ Zip _____

*PA residents add 6% sales tax.

printer by running a utility program called Chooser.II (see figure 6). If you choose a LaserWriter, Chooser.II sends ImageWriter emulation software to it so that it will behave just like an ImageWriter. To print over the network, just specify slot 7 as the printer slot in your application program.

Third-party IIGS software that follows the standard desktop interface should have a Choose Printer option in the File menu, which you can use to choose a network printer. If you choose a LaserWriter, your program will call on the GS Print Manager to send PostScript commands to the LaserWriter over

the network. PostScript is the page-description language the LaserWriter uses to draw text and graphic images on a page.

The AppleShare Print Server software manages printing requests from workstations, saves printing jobs to disk if the printer is busy, and prints deferred jobs as soon as the printer is free. The net effect is that workstations aren't tied up while they're trying to print, even if someone else is using the printer.

When considering whether to set up an AppleTalk network for your group of Apple II computers, consider first the main benefits:

BUZZWORDS

ACCESS PRIVILEGES.

Permission assigned to individual users or groups of users to view or make changes to certain folders on a server.

APPLESHARE. The file server software sold by Apple Computer.

APPLETALK. The set of protocols and conventions comprising Apple's local-area network.

CHOOSE. A program for selecting which printer you want to use on an AppleTalk network.

AFP. AppleTalk Filing Protocol. A standard file-handling scheme used by an AppleShare file server. Workstations have translators to convert commands from the native operating-system format to AFP format. AFP lets you connect ProDOS, MS-DOS, and Macintosh workstations to the network.

DISK SERVER. A computer that partitions a hard disk into several discrete volumes and lets network users access only their own volumes. Users can't open files on volumes assigned to other users.

FILE SERVER. A computer on a network that manages access to files on a hard disk. Users can access other users' files, given the proper access privileges.

GROUP. A collection of registered users to which the network administrator assigns a name.

GUEST. A user who logs onto an AppleShare file server without specifying a user name. Everyone has access to files and folders

guests create on the server.

LOCALTALK. An AppleTalk cabling scheme from Apple involving shielded, twisted-pair cables.

NETWORK. A system of interconnected computers and peripherals.

NETWORK ADMINISTRATOR. The person responsible for the operation of a network. The administrator sets up user and group lists and assigns passwords.

NODE. Any device connected to a network, such as a workstation or printer.

PASSWORD. A secret combination of characters that is sometimes required to log onto a file server.

REGISTERED USER. A user who logs onto an AppleShare file server by specifying a valid user name and password.

SPOOLER. A program that manages printers on a network. It accepts print requests from workstations and forwards them to the printer when the printer is ready, thus freeing up the workstation to do other tasks even if the printer is in use.

VOLUME. Usually a single disk device. A disk server can create multiple logical volumes on a single drive, however.

WORKSTATION. A networked computer that can run application programs and also take advantage of network services. —Gary Little

NETWORK

work-group efficiency and the ability to share expensive peripherals such as Apple's new CD-ROM drive or the LaserWriter printer. In other words, no more trotting disks down the hall to coworkers; no more waiting in line to work with a computer connected to a printer; and, for teachers, no more wasting time while you distribute program disks at the beginning of every class and collect them at the end.

You can also take advantage of useful software specifically designed for a network setting—electronic mail and multiuser database programs, for example. Apple will soon sell a teacher/student network-management program called Aristotle, which teachers can use to specify which programs on a file server the members of a particular class are permitted to use.

The network should also reduce your disk-drive budget—since Apple IIs can boot directly from the file server, you won't have to buy as many drives for your workstations, or any at all for that matter.

Although AppleShare is very slick, it is clearly not for everyone. Keep in mind that it works only with ProDOS-based software. If you are using some DOS 3.3-, Pascal-, or CP/M-based software, you won't be able to take full advantage of the network. Even some ProDOS programs may not work perfectly, but, in most cases, only minor changes will be necessary to make them "network aware."

And then there's the matter of price. First, each IIe requires a \$249 workstation card and perhaps a \$70 enhancement kit if you haven't yet enhanced your IIe. (Advice to everyone: Stop buying the IIe. The GS has always been more economical, and its built-in AppleTalk port makes it even more so if you're considering an AppleTalk network.) You also need a \$75 LocalTalk Connector Kit for each computer, perhaps some extra LocalTalk cable (\$75 for a ten-meter extension), and—the real kicker—a Mac with at least a 20-mega-byte hard-disk drive (\$3578 for a Mac Plus), AppleShare File Server software (\$799), and AppleShare Print Server software (\$299). We expect educational discounts will be available for all these products.

APPLE'S NEW NETWORKING PRODUCTS

Apple II Workstation Card, \$249
Aristotle, \$199 per server
AppleShare File Server 2.0, \$799 per server
AppleShare IIGS Workstation Software, \$99 per server
AppleShare Print Server, \$299 per server

CLASSROOM EDITIONS AVAILABLE



A classic education starts right here.

- IBM PC and Compatibles
- Apple II Series
- Macintosh



CHILDREN'S SOFTWARE™

For information about Compu-Teach software, call toll-free: 1-800-44-TEACH (CT: 203-777-7738).

Compu-Teach Software is available at fine dealers coast-to-coast.

CIRCLE 192 ON READER SERVICE CARD

You never knew your Apple IIgs™ could sound so good.

Buy a Bose® RoomMate® powered speaker system with your new IIgs or Apple® MIDI interface, and Bose will send you an exciting music product—FREE.



KidsNotes allows children to explore many aspects of music and create their own songs on a piano screen keyboard. *ABKey*, a fun letter recognition/keyboard skill program, contains many levels of challenge.

MDIdeas' SuperSonic™ Stereo Card

Hear your Apple IIgs in true stereo! SuperSonic taps the powerful new Ensoniq™ sound chip of the IIgs so you can hear the exciting stereo sounds of popular music software, like the three previously mentioned, in real stereo. Advanced circuitry and multistage filters ensure distortion-free audio.

Act now.

Audition the IIgs paired with the Bose RoomMate system at your authorized Apple dealer. Or, order a RoomMate system by calling 1-800-526-5313 (in NJ call 201-728-8080). To get your free music product, send proof of purchase from Apple IIgs or Apple MIDI interface along with RoomMate proof of purchase and warranty card to: Bose FREE Software Offer, PO Box 8204, Beaverton, OR 97076. Allow 7-9 weeks for delivery. Offer expires September 30, 1988.

Turn your IIgs into a high fidelity musical tool.

If you're a music maker, your system is not complete without the RoomMate powered speaker system from Bose—a world leader in innovative audio products.

The RoomMate system unlocks the full potential of the IIgs's digital sound synthesizer chip. Simply plug the RoomMate system into the IIgs's earphone jack and your room is filled with faithfully reproduced sound—from a symphony to a human voice to a crashing wave. The Bose RoomMate system also brings out the best in MIDI keyboards, portable CD players and personal stereos.

Since looks are as important as sound, we designed a Special Edition RoomMate system

with a platinum cabinet and grilles to match your IIgs.

Get a high quality music product free—up to a \$99.95 value.

Buy a Bose RoomMate system along with either an Apple IIgs or Apple MIDI interface between May 1, 1988 and September 30, 1988, and we'll send you one of the following free:

Activision's *The Music Studio™ 2.0*

The new *Music Studio version 2.0* is the only IIgs music software with *real time MIDI input* plus *more than 15 new features*, including new digitized instruments and a "Jukebox" that automatically plays any selection of songs. The *Music Studio 2.0* combines power with ease-of-use for musicians at all levels. Compose and edit music, add lyrics, print sheet music, adjust MIDI parameters, edit instrument sounds, and more!

Electronic Arts' *Music Construction Set®*

Designed expressly for the IIgs, *Music Construction Set* makes it easy to compose and edit music. You can write 15-voice music using professional notation found in no other Apple IIgs software, then play your work on over two dozen new digitized instruments that sound sensationally real. When your work is done, print out high-quality sheet music.

Great Wave's *KidsTime™ II*

Created for children aged three to ten, *KidsTime II* has two educational programs emphasizing creativity, exploration and skill development.

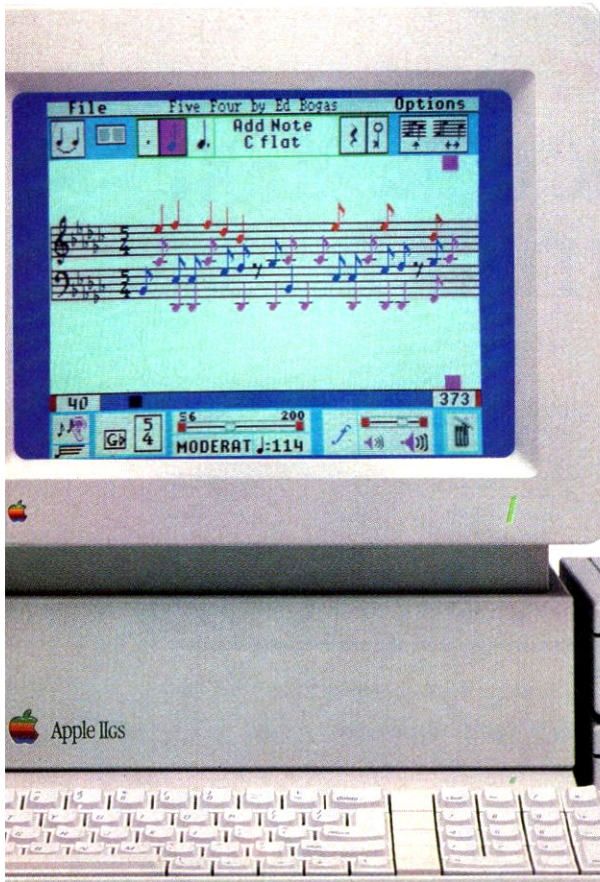

BOSE®
Better sound through research.

© Copyright 1988 Bose Corporation. All rights reserved. Covered by patent rights issued and/or pending. Features and specifications subject to change without notice. Apple and the Apple logo are registered trademarks of Apple Computer Inc. Apple IIgs and the Apple colors are trademarks of Apple Computer Inc. Bose and RoomMate are registered trademarks of Bose Corporation. Music Construction Set is a registered trademark of Electronics Arts, Inc. KidsTime and Great Wave are trademarks of Great Wave Software. The Music Studio is a trademark of Activision. SuperSonic is a trademark of MDIdeas.

CIRCLE 313 ON READER SERVICE CARD
Software: *The Music Studio 2.0* by Activision.

*Comparing Omninnet
with AppleTalk*

THE CORVUS ALTERNATIVE

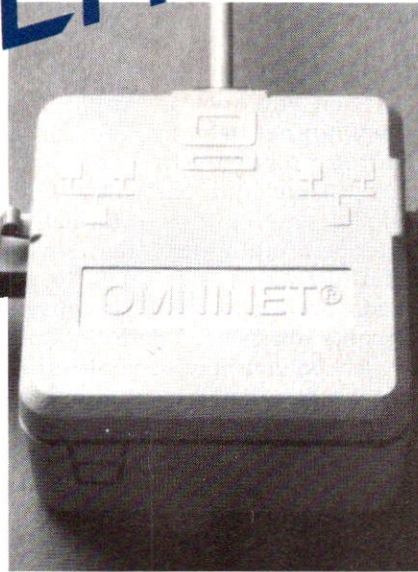

Apple's entry into the Apple II network market is getting a lot of attention, but does Apple provide the best method for networking Apple II computers? Maybe, maybe not. In this article, we're going to take a good look at an old-timer in this market, Control Data/Corvus, and see how its network compares with Apple's.

Corvus is the pioneer that brought hard-disk drives to the Apple II world in 1979. In 1980 Corvus introduced its Constellation I network software. It used Corvus' disk multiplexer, a device that lets eight computers share a single hard disk. The following year, Corvus announced Omninnet, a conventional network with a transmission rate of 1 Mbps (megabit per second). In 1984, Corvus came out with a network-management-software system called Constellation II, which greatly increased the capabilities of Omninnet. For the first time, for example, you could use the ProDOS operating system. Constellation III, introduced last summer, features a convenient pull-down-menu interface and extensive on-line help.

Earlier this year, Control Data Corporation teamed up with Corvus to market the Omninnet. Con-

trol Data/Corvus estimates that there are more than 12,000 Apple II Omninnet networks worldwide, which tie together more than 120,000 computers.

Omninet can handle Apple II, Macintosh, and MS-DOS computers together on the same network. It also allows for simultaneous use of the ProDOS, DOS 3.3, Pascal, CP/M, Macintosh, and MS-DOS operating systems, although moving files from one system to another is not that convenient. Each Omninnet network can accommodate up to 63 computers and as many as 10 drives, with a total of one gigabyte of disk storage. Contrast this capacity with that of Apple's network, which can handle up to 32 devices and the ProDOS, Macintosh, and MS-DOS operating systems only.

Speed: That's the Ticket

Connecting multiple computers is a means for sharing expensive peripheral equipment, using a cen-

tral supply of application software, exchanging files and data, and sending electronic messages. A primary concern for any network user is that speed not be compromised. Ideally, network printers and hard-disk drives respond just as quickly as locally connected devices. Omninnet shines in this area.

Omninet is significantly faster than a LocalTalk implementation of AppleTalk. Why? For one thing, its 1-Mbps raw data-transmission rate, the speed at which data moves through the network wires, is about four times the AppleTalk rate. The effective AppleTalk rate is even slower because Apple's network software takes quite a while to create a network data packet before actually sending it. Refer to "AppleTalk Cabling Schemes" in this issue for author Don Lancaster's comments on the effective transfer rate through an AppleTalk network.

Dollar for Dollar

Besides speed, expense is a consideration. The biggest-ticket item for AppleShare is the Macintosh you need to run the AppleShare File Server software. A Macintosh Plus with an Apple 20-megabyte SCSI hard-disk drive has a suggested retail price of \$3578. Since it is



The Corvus 21-megabyte OmniDrive disk server

dedicated to acting as the file server, you cannot use the Mac as a network workstation. The AppleShare File Server software is an additional \$799, and the AppleShare Print Server software is \$299. Each of the computers needs a \$75 LocalTalk Connector Kit, and any IIe computers also require the \$249 Apple II Workstation Card. So the total for a sample network connecting five Apple IIe computers comes to \$6371, a price that does not include the cost of the extra LocalTalk cable you will probably need.

Here's how a Corvus system adds up, in comparison. A Corvus 21-megabyte OmniDrive disk server (a stand-alone unit) has a suggested retail price of \$2795. To this figure add \$695 for the Constellation III network-management and diagnostic software (it includes operating systems, utilities, and printer-server software). The print server is a stand-alone IIe (\$829) with an Omninet Network Interface Card (\$249) and up to six standard printer-interface cards. Each Apple II workstation needs a \$249 Omninet Network Interface Card, a \$45 cable with a network box for each computer, and a \$65 print-spooler card. Thus, our sample network connecting five Apple IIe workstations comes to \$6453 for Omninet, or about the same as the cost of an AppleTalk network. Extra cable is relatively inexpensive (\$149 for 500 feet), however.

AppleTalk is less expensive if you're networking IIGS computers—they don't need the Apple II Workstation Card for AppleTalk, but they still need the Network Interface Card for Omninet.

Using Omninet

When you boot an Apple II on the Omninet network, the Corvus startup program asks you to enter your name and password. Once you've entered this information, the operating system the network administrator has assigned to you loads, and up to ten disk volumes become available. These volumes, which behave like separate disks, can be designated as read-only or read/write. You can get access to additional volumes during a session by removing and adding any of a maximum of 24 volumes. With ProDOS, the Corvus volumes, after the first two, appear as ProDOS volumes with "phantom" slot and drive assignments, and you can use them just like locally connected drives.

At this point, you should begin

to see some of the design differences between the Omninet server and Apple's AppleShare server. On an AppleShare server, all users see the hard disk as the same big volume and can store files and create folders anywhere on the volume (subject to access restrictions). With Omninet, users gain access to specific private portions of the hard disk, which appear to be discrete disk volumes. That's why the Omninet server is called a disk server and AppleShare a file server.

Omninet has several problems, some minor, some not so minor. Updating the Omninet operating system or driver software is difficult unless you're content to wait for new updates to the Constellation disks from Control Data/Corvus. The operating system and driver software are stored in Pascal files, regardless of the operating system, meaning that their replacement or correction requires conversion to the Pascal format. You cannot just place a new version of the PRODOS file in the ProDOS boot volume.

Also, exchanging disk files with other users on the server is awkward, because files sit in their users' separate volumes, unless the administrator happens to allow two users access to the same volume. To exchange a file, you first have to send it to a special transfer area on the server; to complete the transfer, the recipient has to re-

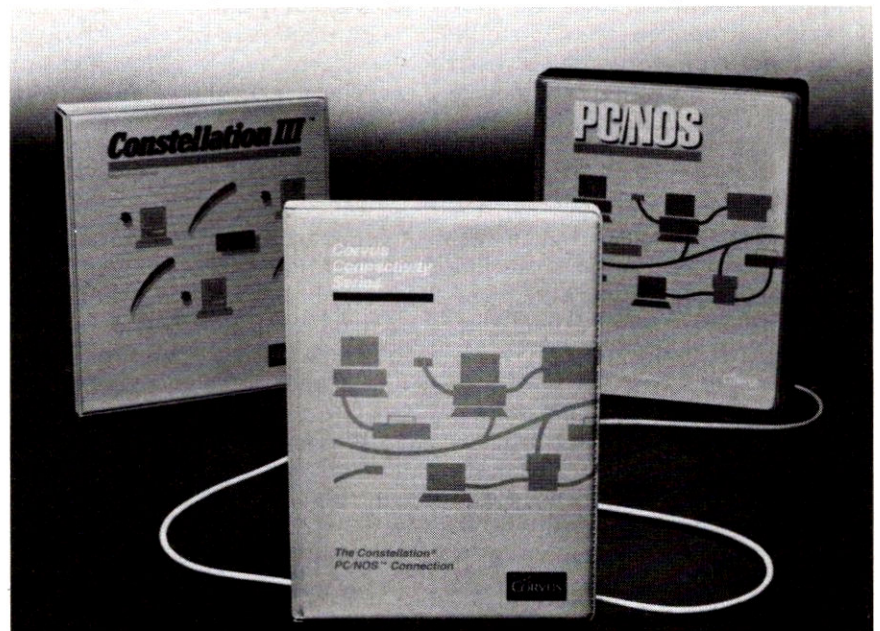

Constellation and PC/NOS are the network management programs for Omninet.

Log on to Scholastic Software

You are invited to enter a new era of educational technology—
with 7 Apple Share Aware™ titles for the AppleTalk Network.™

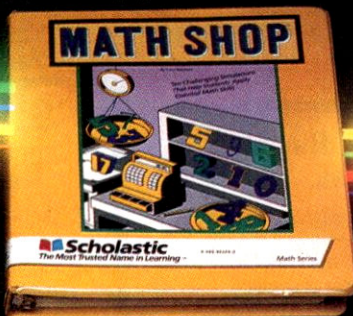
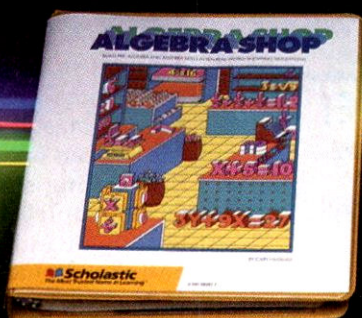

America's leading educational software publisher is leading the way again.
First Scholastic pioneered the development of instructionally
relevant and easy-to-use school software.

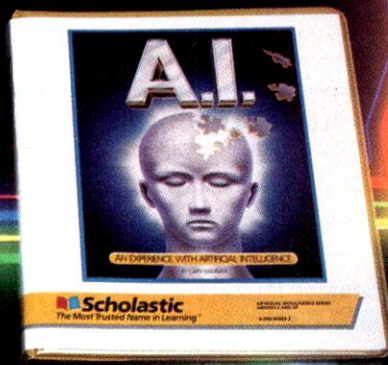
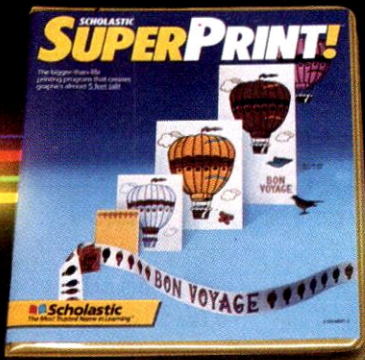

Now Scholastic is at the forefront in supporting technological
innovations that expand your access to this outstanding software—
with new Apple Share Aware™ titles for the new AppleTalk Network.™

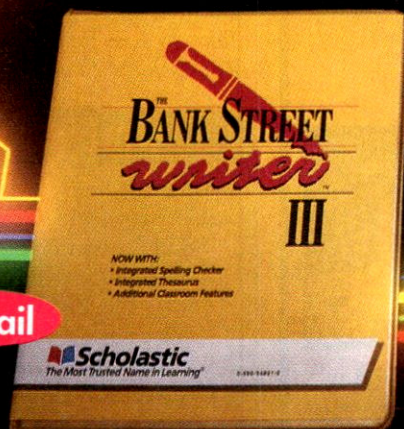

E-Mail

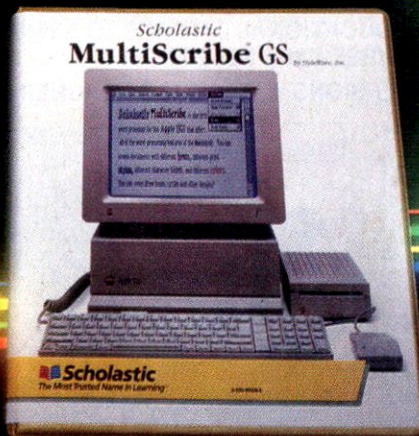

For free details, call TOLL-FREE 800-325-6149. Or use the Reader's Service Card.

CIRCLE 302 ON READER SERVICE CARD

SCHOLASTIC

The Most Trusted Name in Learning
P.O. Box 7502, 2931 E. McCarty St., Jefferson City, MO 65102

GUARANTEED VALUE!

3.5" DS/DD
135 TPI Diskettes
\$1.09 ea.
Qty of 100

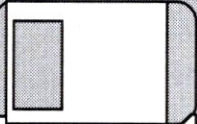

Incl. Color-Coded User Labels
\$1.19 ea. qty of 50
\$1.29 ea. qty of 25

FREE...
shipping for
orders
of \$100 or
more!
(Otherwise
add only
\$3.50!)

5.25" DS/DD Diskettes
33¢ ea. Qty of 100



Incl. Tyvek Sleeves, Labels,
& Write Protect Tabs

Imagewriter™ Ribbons!
\$3.95 ea.

Colors are available!

- NO EXTRA CHARGE for VISA/MC.
- Check or Money Order accepted!
- Please add \$2.50 for C.O.D.
- Ohio residents add 5.5% sales tax.

GUARANTEE!

**ORDERS SHIP IN ONE
BUSINESS DAY!**

- Diskettes are 100% certified DS/DD Error Free!
- If you are not completely satisfied, simply return the product for refund or replacement.

DIRECT MICRO
1776 Dividend Drive
Columbus, Ohio 43228
(614)-771-8771

TO ORDER CALL

1-800-288-2887

Hours: 9 a.m.-7 p.m. EST

CIRCLE 173 ON READER SERVICE CARD

CALL FOR
FREE CATALOG



DISKETTES 38¢
IMAGEWRIER RIBBONS \$2.99
MULTICOLOR RIBBONS \$7.95

YOUR SINGLE SOURCE SUPPLIER FOR COMPUTER SOFTWARE • DISKETTES • ACCESSORIES

NATIONWIDE TOLLFREE
1-800-624-2926



IN ILLINOIS CALL
312-884-7040

SAVE UP TO 45% EVERYDAY!

NOW YOU CAN BUY WHERE THE SCHOOLS BUY

- OVER 5,000 SOFTWARE TITLES AVAILABLE
- NATIONWIDE TOLL FREE SERVICE
- TRAINED EDUCATIONAL EXPERTS TO ASSIST YOU IN COURSEWARE SELECTION
- SCHOOL VERSIONS W/BACKUP & TEACHER MATERIALS

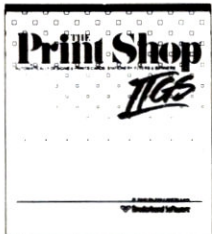

Your Cost
\$27.95 APL/C64
\$35.95 IBM/IIGS
Sch. Vers. Add \$7.00

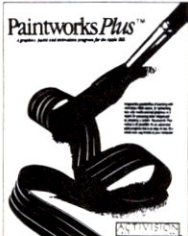

Your Cost
\$45.95 APL IIGS
W/CLIPART
3 Pk. - Paint/Write/Draw \$119.95



Your Cost
\$26.95 APL/IBM/C64
School Version \$37.95
Lab Pack \$87.95



Your Cost
\$21.95
APL/IIGS/IBM/MAC/C64

MAIL SCHOOL P.O.'S TO:

EDUCATIONAL RESOURCES
2360 HASSEL ROAD
HOFFMAN ESTATES, IL 60195



CIRCLE 183 ON READER SERVICE CARD



trieve it from the transfer area.

Perhaps the most serious problem with the Omninet network at present is that you cannot use it with an Apple IIGS running in the Fast mode. This limitation makes running super-hi-res desktop applications painfully slow. Corvus is aware of this problem and is working on a solution.

Decisions, Decisions

You may prefer Omninet over AppleTalk because it's faster with Apple IIe's, and it does not require a Macintosh (meaning you won't have to master another computer). Also, it can handle all major Apple II operating systems, not just ProDOS. AppleTalk/AppleShare, on the other hand, is better for file and peripheral sharing and can be less expensive, particularly if you have a lot of IIGS computers.

Corvus technical support has a reputation for high-quality service. Apple's support is as yet untested, but we can surmise that Apple's dealers will support this product as well as they support the rest of the Apple line.

Even though the momentum of the Apple label could propel AppleTalk and AppleShare into the forefront, the performance and reliability of Omninet make it a worthy competitor. +

Tom Vier has been the Washington Apple Pi user group's Corvus expert for more than five years. He also works with a much larger network as a senior transmission engineer for the American Broadcasting Company in Washington, D.C. If you have a pre-OmniDrive Corvus system, contact Tom c/o A+ for information on a new ROM that lets you run ProDOS.

VITAL STATISTICS

Omninet

Control Data/Corvus
8800 Queen Avenue South
Bloomington, MN 55431
(800) 328-1109

List Price: Omninet Omni-Drive, \$2795 (21 megabytes); Omninet Network Interface Card, \$249; Omninet Network Box, \$45; Omninet Print Spooler Card, \$65; Constellation III software, \$695

CIRCLE READER SERVICE NO. 365

**The
best-selling
Apple
software
just got
the ultimate
upgrade.**

Its own C

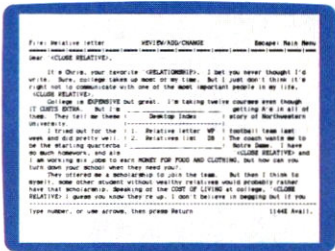
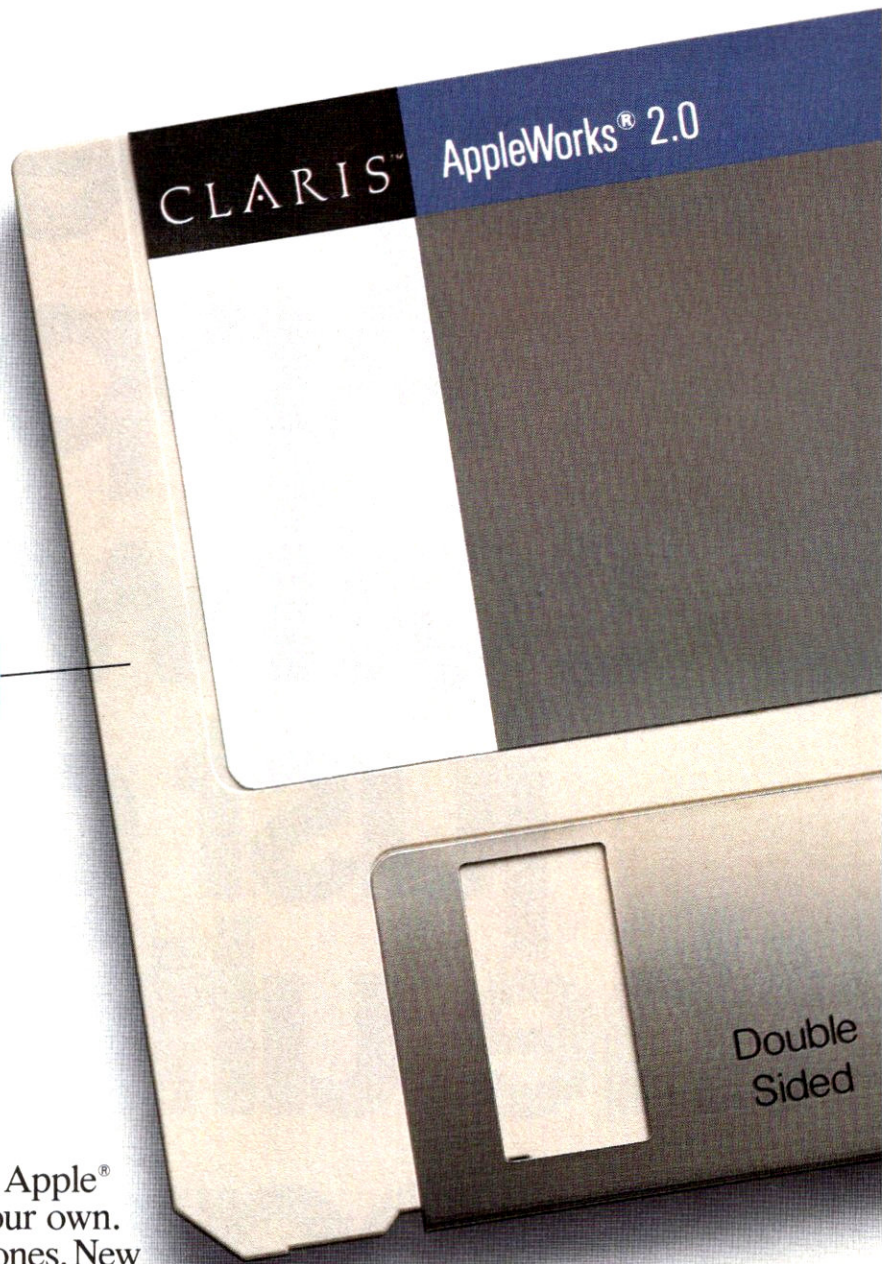

AppleWorks' powerful word processor has headers, footers and on-screen page breaks. Now, mail merge integrates database information with text.

Presenting Claris™ 1.0.
We used to be a part of Apple®
Computer. Now we are on our own.
New stationery. New phones. New
offices. The whole bit.

And here we are, while the halls are
still filled with the scent of new carpet,
introducing a more powerful version of
the best-selling Apple program in history.
Or should we say, the three best-

selling Apple programs in
history. Because AppleWorks® already
included a sophisticated word processor,
full-function spreadsheet and heavy-duty
database manager in a single, easy-to-use
integrated package.

ompany.

File: College costs	REV: 04-23-88	CHANGES	ENCLOS: 0	Page: 1
10	02	02	00	00
11	02	02	00	00
12	02	02	00	00
13	02	02	00	00
14	02	02	00	00
15	02	02	00	00
16	02	02	00	00
17	02	02	00	00
18	02	02	00	00
19	02	02	00	00
20	02	02	00	00
21	02	02	00	00
22	02	02	00	00
23	02	02	00	00
24	02	02	00	00
25	02	02	00	00
26	02	02	00	00
27	02	02	00	00
28	02	02	00	00
29	02	02	00	00
30	02	02	00	00
31	02	02	00	00
32	02	02	00	00
33	02	02	00	00
34	02	02	00	00
35	02	02	00	00
36	02	02	00	00
37	02	02	00	00
38	02	02	00	00
39	02	02	00	00
40	02	02	00	00
41	02	02	00	00
42	02	02	00	00
43	02	02	00	00
44	02	02	00	00
45	02	02	00	00
46	02	02	00	00
47	02	02	00	00
48	02	02	00	00
49	02	02	00	00
50	02	02	00	00
51	02	02	00	00
52	02	02	00	00
53	02	02	00	00
54	02	02	00	00
55	02	02	00	00
56	02	02	00	00
57	02	02	00	00
58	02	02	00	00
59	02	02	00	00
60	02	02	00	00
61	02	02	00	00
62	02	02	00	00
63	02	02	00	00
64	02	02	00	00
65	02	02	00	00
66	02	02	00	00
67	02	02	00	00
68	02	02	00	00
69	02	02	00	00
70	02	02	00	00
71	02	02	00	00
72	02	02	00	00
73	02	02	00	00
74	02	02	00	00
75	02	02	00	00
76	02	02	00	00
77	02	02	00	00
78	02	02	00	00
79	02	02	00	00
80	02	02	00	00
81	02	02	00	00
82	02	02	00	00
83	02	02	00	00
84	02	02	00	00
85	02	02	00	00
86	02	02	00	00
87	02	02	00	00
88	02	02	00	00
89	02	02	00	00
90	02	02	00	00
91	02	02	00	00
92	02	02	00	00
93	02	02	00	00
94	02	02	00	00
95	02	02	00	00
96	02	02	00	00
97	02	02	00	00
98	02	02	00	00
99	02	02	00	00
100	02	02	00	00

Without swapping disks, AppleWorks jumps to its powerful spreadsheet for heavy-duty number crunching.

File: Relatives List	Page: 1			
NAME	RELATIVE	ADDRESS	CITY	EST. GROSS INCOME
John Stone	Uncle	One Chatham Court	Beverly Hills, CA	\$100,000
Paula Roberts	Sister	2 Southampton Road	San Fran, CA	\$150,000
John DeLong	Brother	1 Madison Avenue, Penth	New York, NY	\$1,200,000
Caroline Chandler	Sister	200 North Michigan Ave.	Chicago, IL	\$120,000
John Price	Brother	87 Shaker Lane	Shaker Heights, OH	\$60,000
Paula F. Roberts	Sister	65 Westmoreland St.	Cambridge, MA	\$177,000
Paula F. Roberts	Sister	1000 University Ave.	Lawrence, MA	\$1,100,000
John Stone	Uncle	88 River Road	Santa Cruz, CA	\$500,000
John Stone	Uncle	112 South Main	Seattle, WA	\$500,000
John Stone	Uncle	1 Vanhook Drive	North Haven, CT	\$200,000
Paula Roberts	Sister	3000 11th Ave	Manhattan, NY	\$200,000

A few keystrokes, and you arrive at the impressive AppleWorks database. Organize, file, sort and manipulate vital info—from your record collection to VIP addresses.

AppleWorks 2.0 is even better. It has extended memory support. So you can take advantage of the new power of the Apple IIGS.[®]

And it has mail merge capability. So you can do things like start a mail-order business in the spare bedroom.

Or, take your traditional copy machine holiday letter and personalize it for thousands of very close friends. (Speaking

of personal, there's an upgrade information kit waiting for you at 800-544-8554.) But here's where things get really exciting.

Because the whole point of Claris is to create better Apple software than anyone has ever seen before. And to bring a whole new vision to the world's computer screens. It's all coming to an Apple computer near you. Stay tuned.



For more information and the location of the nearest Claris dealer call (800) 334-3535. For information in Canada call (800) 668-8948.

CIRCLE 322 ON READER SERVICE CARD

PROVEN TO INCREASE SAT SCORES*

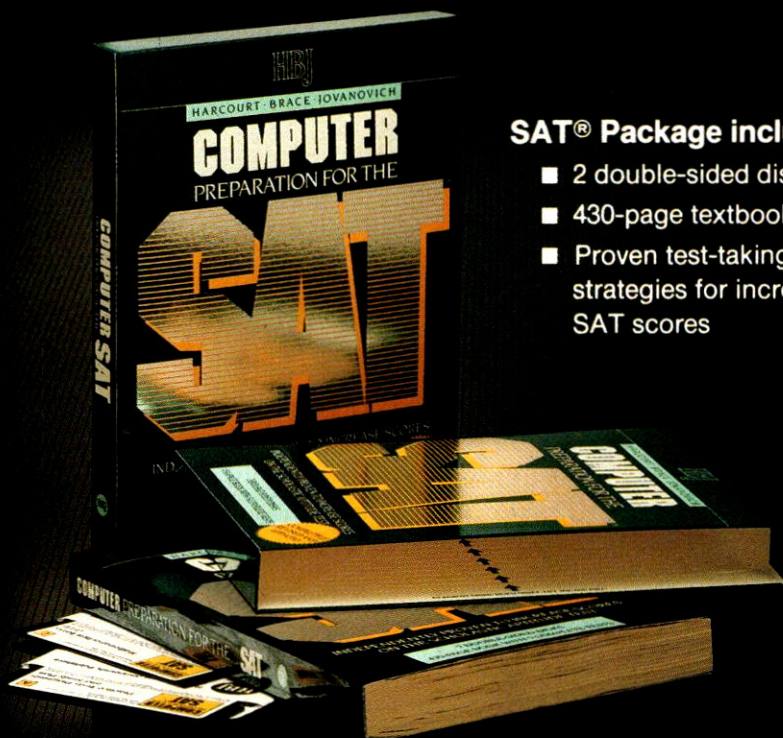

SAT® Package includes:

- 2 double-sided disks
- 430-page textbook
- Proven test-taking strategies for increasing SAT scores

Computer Preparation for the SAT
available for:

- Apple® II Series with 48K and Applesoft® **\$39.95**
- IBM® PC & PCjr. with 128K **\$39.95**

Computer Preparation for the ACT
available for:

- Apple® II Series with 48K and Applesoft® **\$42.50**
- IBM® PC & PCjr. with 128K and graphics card **\$42.50**

Why HBJ's Test Preparation Series Increases Test Scores

- Accelerates learning by combining books with software
- Offers real test-taking experience with full-length exams
- Diagnoses individual strengths and weaknesses in key SAT and ACT areas
- Generates a personalized study plan
- Provides immediate feedback on hundreds of computer drill items

- Automatically times and scores practice tests and drills
- Reveals sure-fire strategies for scoring high

CIRCLE 175 ON READER SERVICE CARD

- Builds test-taking skills and confidence in just a few hours
- Includes toll-free technical assistance and full-year warranty on disks
- Requires no previous computer experience

*Through independent research conducted at Florida State University and the University of Southern Mississippi

HBJ

Harcourt Brace Jovanovich, Publishers

465 South Lincoln Dr., Troy, MO 63379

Toll-Free (800) 543-1918 In MO and AK collect (314) 528-8110

*A quick
rundown of
other Apple II
alternatives*

OTHER NETWORKS

Besides Apple and Corvus, three other companies are significant players in the Apple II network market. Here's a look at what they have to offer and what their strengths and weaknesses are. You'll see that LanTech offers a file server, whereas Velan and Major Educational Resources offer disk servers. The difference between the two types of servers is that a file server allows users to share all files on the server hard disk (which is what AppleShare does), whereas a disk server allows users to have private areas on a shared disk—the users can't share files directly.

LanTech's ELAN

LanTech specializes in Apple II networks for schools. Its current installed base is approximately 300 networks, which average 20-25 workstations each.

LanTech offers file/print/boot servers and workstation cards, which together form ELAN (Educational Local Area Network). The server is an Apple IIe running LanTech's proprietary operating system, AROS; it connects to workstations with interface cards called Satellite Boards. Workstations that run ProDOS require an additional EXpander Board. The network can

have as many as 128 workstations and can be up to 1000 feet long.

To create a LanTech ELAN server, you first need a 128K Apple IIe with a 5¼-inch disk drive and monitor (\$1326). For it you need a LanTech Satellite Board (\$189) and cable assembly (\$17), the LanTech AROS Operating System (\$400), a 20-megabyte LanTech hard-disk drive (\$1295), a hard-disk interface (\$100), and a Super Serial Card for each of up to four printers (\$139 each). The total server cost, including the IIe itself and four serial cards, is \$3883.

Each workstation requires a Sat-



Photo of a typical ELAN environment

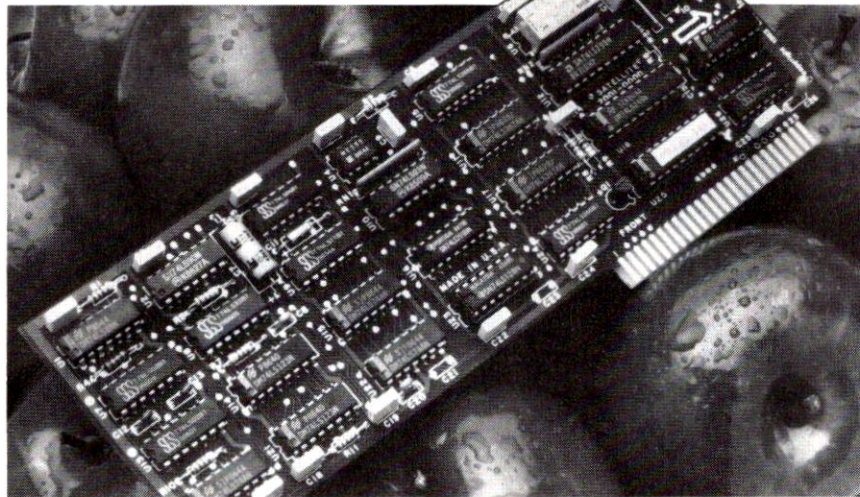

The LanTech Satellite Board

elite Board (\$189), a ten-foot cable assembly (\$17), and an EXpander Board for ProDOS (\$120), which totals \$326.

Thus, the cost for a five-workstation network comes to \$5513, not including the cost of the Apple IIe workstations. To see how this price compares to the cost for a similar AppleTalk or Omninet network, see the chart "Networks at a

Glance" on page 50. Like Apple and Corvus, LanTech offers educational discounts.

The file-server software features automatic file locking for both DOS 3.3 and ProDOS 8. (File locking prevents conflicts when more than one person tries to use a file at the same time.) The network cannot handle Pascal and CP/M. It can accommodate up to six disk drives

with volumes as large as 32 megabytes and uses a disk-caching scheme to improve the speed of disk access over the network.

Other than a menu-setup utility program, no classroom-management or automatic-lesson-collection software is provided by LanTech, but the company is working with software publishers that provide such software.

ELAN's print service provides spooling (print-job queuing) for up to four printers, which you get by adding printer-interface cards to the IIe server. You can spool as many as eight documents. It works with dot-matrix printers such as the ImageWriter but not with the LaserWriter.

ELAN works with the Apple II Plus and the IIe (enhanced or not) but not with the IIc or the IIGS running ProDOS 16 applications.

ELAN is perhaps the most similar network to AppleShare/AppleTalk, in that it offers file, print, and boot service. One of LanTech's strengths is that it allows schools to use Apple IIe equipment they may

TALK!

Presenting First Byte's Talking Educational Library. Exciting learning activities for children ages 3 to 12. Available for the Apple IIGS and Macintosh Computers. *No additional speech hardware required.* Suggested retail price \$19.95-49.95

- Dealer Inquiries call 800-448-8822
- Special Educational Discount for Schools
- See us at the Electronic Arts booth at AppleFest and NECC

For ordering and catalog information call... **800-245-4525 (USA & CANADA)**

First Byte, 3333 East Spring Street, Long Beach, CA 90806 213-595-7006
 Apple IIGS and Macintosh are trademarks of Apple Computer Inc. © First Byte 1988.



CIRCLE 149 ON READER SERVICE CARD

GO AHEAD AND DRAW YOUR OWN CONCLUSIONS.



PRINT MAGIC™

This is from Print Magic's graphics library.
Note the extreme detail.

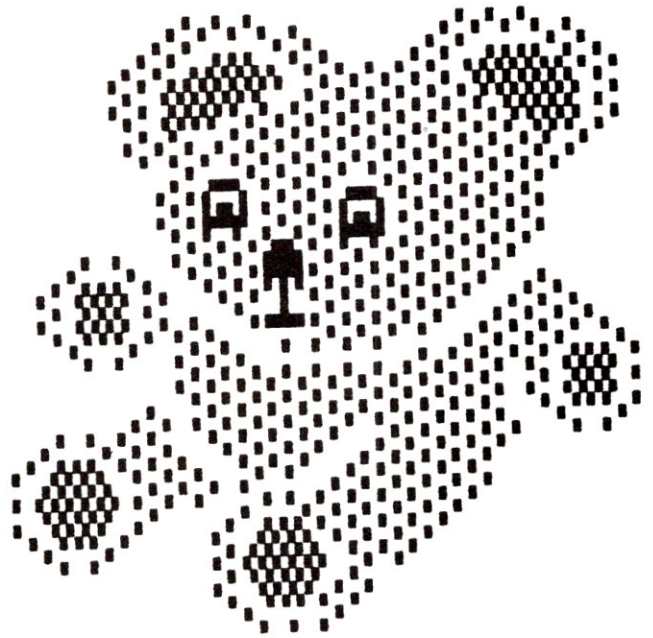

PRINT SHOP™

Print Shop's bear is barely there.

They say a picture is worth a thousand words. So go ahead and compare bears.

Now, for those who still need a few words, consider the following*:

Print Magic™ allows users to place an unlimited number of fonts, graphics and borders anywhere on the page or card. *Print Shop*™ doesn't.

Print Magic graphics can be enlarged up to six times. *Print Shop*, just three.** *Print Magic* borders can be sized in nine thicknesses. *Print Shop* offers a single standard size for each border.

And *Print Magic* comes with

a complete set of paint tools, including 24 paintbrushes, 5 pen sizes, fill patterns, and circles, ovals, boxes, rectangles and lines. *Print Shop*? Well, you get the idea.**

Finally, while *Print Shop* lets users work on just a piece of the page at a time, *Print Magic* lets users work on the full page. So no preview is necessary.

To make a long advertisement short, no other software of its type gives you as many choices or as much power of expression as *Print Magic*.

BUT PRINT SHOP DOES HAVE SOME REDEEMING VALUE.

Why not draw your own glorious conclusions? Right now, you can save a slick \$40 off the price of *Print Magic* simply by sending in your *Print Shop* manual cover and \$19.95, plus \$2.95 for shipping. And you'll get a bonus graphics disk absolutely free. But the offer ends June 30, 1988 so read the fine print quickly.

Print Magic offer is available for Apple IIe/c/gs and IBM and compatibles. Allow 4-6 weeks for delivery. When ordering, specify computer type and send your check or money order plus the front cover of your *Print Shop* manual to: Epyx, Inc., 2995 Woodside Road, Dept. 004, Suite 400-383, Woodside, CA 94062.



PRINT MAGIC

BY Epyx

*product comparisons for Apple IIe/c/gs, IBM and compatibles
**excludes *Print Shop* Apple IIgs

Print Magic is a trademark of Epyx, Inc. *The Print Shop* is a trademark of Broderbund Software, Inc. The graphics were printed using an Apple IIc and ImageWriter® printer.

CIRCLE 147 ON READER SERVICE CARD

already have, which helps reduce the already relatively low cost, and it works with DOS 3.3 and ProDOS 8. (AppleShare works with ProDOS 8 and 16.) The network transfer rate is also faster than AppleTalk.

Some weaknesses are its expensive cabling and connectors and the requirement of a second \$120 card in each workstation to run ProDOS. Although the file service is impressive for a product priced so low, the security and system-management capabilities are simplistic. Print service is reasonable with four printers but needs more flexibility and expansion possibilities beyond spooling eight jobs. Technical support is limited to the central factory location and not available locally.

Velan VNET

Velan was founded in 1985 to develop classroom networking systems. Headquartered in California, it operates four regional sales offices. Velan now has more than 100 networks installed nationwide.

The company offers a combina-

tion disk/print/boot server based on an unusual animal for the typical K-12 classroom—an IBM PC/AT (or compatible).

The first thing you can say about Velan's network technology is that it is different. First, each workstation connects directly to a central server rather than to the next device in a chain of devices, in a so-called star configuration. Second, the network interface is simply a standard serial port. The network can include as many as 64 workstations, and the cabling can be up to 1000 feet long.

Velan sells its servers as upgrade packages for existing PC/AT computers but most often delivers them in complete bundles with an IBM PC/AT or compatible, a hard-disk drive, serial cards with 16 ports, server software, classroom-management software, and menu-driven student software. A 16-port, 20-megabyte server bundle costs \$5745.

Each Apple II or IBM PC work-

station requires a serial-interface card (\$85) and a cable assembly (about \$30). Thus, a five-workstation setup comes to \$6320. Educational discounts are available.

A special \$20 ROM is available for the Apple Super Serial Card that makes it usable as a VNET interface. Computers with built-in serial ports, such as the IIC and Macintosh, can be connected without interface cards, but you need special disks containing drivers.

Velan's file service is basically disk service with some file-locking capabilities. Disk service means that although files from different operating systems can coexist on the server's disk, they cannot be shared. Each user has access to a certain area of the disk and that area only.

Where this odd star really shines in comparison to most other classroom networks is in classroom-management software. Integrated with the system-management software and included with every system is a set of flexible utilities specifically for the classroom:

COMPUTER LAB CHAOS?

If your computer lab looks more like an All-Star Wrestling match than a classroom, the Q-System™ is for you.

COMPUTER LAB ASSIGNMENT:

Write and print out a letter home to Mom or Dad.
Wait for your turn on the printer.

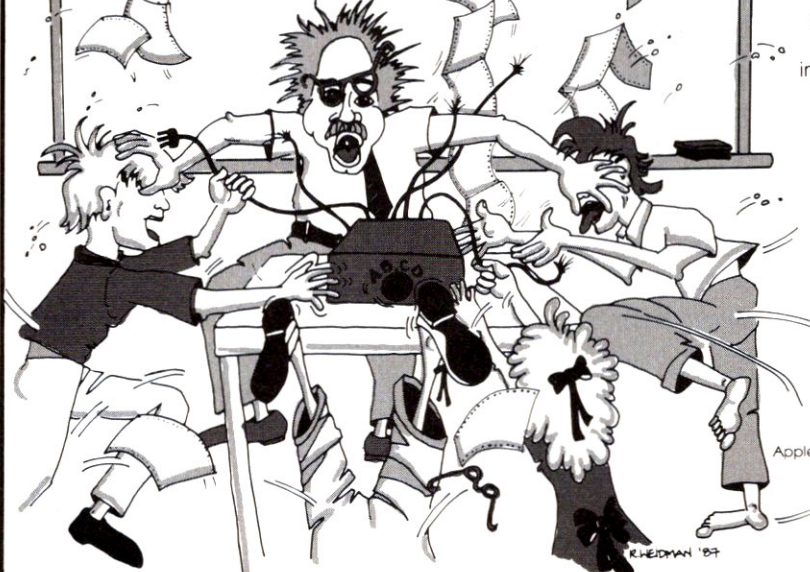

The Q-System™ is THE fully automatic parallel or serial printer sharing product for the Apple II, II+, //e and //gs on an internal card!

The Q-System™ has no switches, buttons, lights or anything else to operate, nor will your students need to learn any special commands. Instead of waiting in line for the printer, the Q-System's™ on-board print buffer lets them continue with other computer work.

For around the same price as a manual system, why not make the switch to the Q-System™? Your computer lab will go from chaos to classroom order without pinning your budget to the mat.

Suggested Retail Price **\$249.95***

Educational Discounts Available.

Q-System PC™ now available for IBM labs!



All Sequential Systems' products are made in the U.S.A. and include an exclusive two year immediate replacement warranty. For more information about Sequential Systems' products contact your dealer or call **1-800-999-1717**

* Price does not include printer cards or cables. Apple II, II+, //e and //gs are registered trademarks of Apple Computer, Inc. IBM is a registered trademark of International Business Machines, Inc.

SEQUENTIAL SYSTEMS
computer products for education

CIRCLE 200 ON READER SERVICE CARD

For Those Who Want the Most. From Those Who Make the Best. GS-RAM™

Now expand the IIGs' RAM and ROM with up to 8 MEG of "Instant On" memory with the all new GS-RAM!

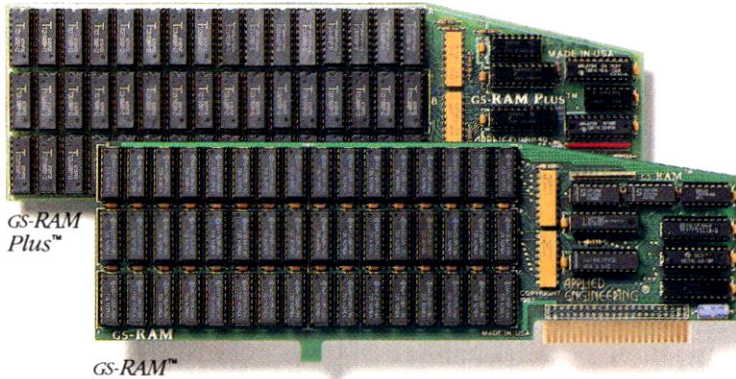

GS-RAM has an all new design. A design that delivers higher performance including increased speed, greater expandability, and improved software.

More Sophisticated, Yet Easier to Use

GS-RAM works with all IIGs software. In fact *any* program that runs on Apple's smaller memory card runs on the GS-RAM. But with GS-RAM you can have more memory, improved performance, and almost unlimited expansion capabilities. We've designed the new GS-RAM to be easier to use too—you don't have to adjust the size of your RAM disk every time you use a DMA device. No other RAM card with more than 4 banks of memory installed can make the same claim.

More than Just Hardware

Each GS-RAM and GS-RAM Plus includes the most powerful set of IIGs software enhancements available anywhere. In fact, our nearest competitor offers only a fraction of the invaluable programs that we include with each GS-RAM card. This software includes the most powerful disk-caching program available, the GS-RAM Cache. The Cache will make most of your applications run up to *7 times faster*. Also included is a diagnostic utility that lets you test your GS-RAM by graphically showing the location of any bad or improperly installed RAM chips. And for AppleWorks users, we give you our exclusive Expander program that dramatically enhances both the capabilities and speed of AppleWorks.

Making AppleWorks Even Better

Applied Engineering's Expander program eliminates AppleWorks internal memory limits allowing it to recognize up to 8 megabytes of desktop workspace. You can increase the limits from only 7,250 lines to 22,600 lines in the word processor and from 6,350 records to 22,600 records in the database. The Expander allows all of AppleWorks, including print functions, to automatically load into RAM. The clipboard size will increase from 255 to 2,042 lines maximum. GS-RAM will automatically segment larger files so you can save them onto multiple floppies. And

GS-RAM provides a built-in print buffer that allows you to continue working in AppleWorks while your printer is still processing text. You can even load Pinpoint or MacroWorks and your favorite spelling checker into RAM for instant response.

Grow by Kilobytes or Megabytes

We offer GS-RAM in two configurations so you can increase your memory 256K at a time (GS-RAM) or a megabyte at a time (GS-RAM Plus). Both are IIGs compatible and both come with our powerful enhancement software. GS-RAM can hold up to 1.5 MEG of 256K chips and GS-RAM Plus can hold up to 6 MEG using 1 MEG chips. And since both use standard RAM chips (not high-priced SIMM's), you'll find expanding your GS-RAM or GS-RAM Plus easy, convenient, and very economical. For further expansion, you can plug a 2 MEG "piggyback" card into the GS-RAM's expansion port for up to 3.5 MEG of total capacity. Or up to a whopping 8 MEG on GS-RAM Plus. If a GS-RAM owner outgrows 3.5 MEG, he can easily upgrade to GS-RAM Plus for a nominal charge.

Permanent Storage for an "Instant On" Apple

With our RamKeeper™ back-up option, your GS-RAM or GS-RAM Plus will retain both programs and data while your IIGs is turned off! Now when you turn your IIGs back on, your favorite software is on your screen in under 4 seconds! With RamKeeper you can divide your IIGs memory into part "electronic hard disk," and part extended RAM. Even change the memory boundaries at any time—and in any way—you want. Because



Steve Wozniak, the creator of Apple Computer

"In quality, performance, compatibility, expandability and support, Applied Engineering's GS-RAM and GS-RAM Plus are number one."

Applied Engineering has the most experience in the industry with battery-backed memory for the Apple, you are assured of the most reliable memory back-up system available. And in the world of battery-backed memory, *Reliability* is everything. That's why Applied Engineering uses state-of-the-art "GEL-CELL's" instead of Ni-Cad batteries (if Ni-Cads aren't discharged periodically, they lose much of their capacity). RamKeeper has about 6 hours of "total power failure" back-up time. That's 6 times the amount of other systems. But with power from your wall outlet, RamKeeper will back-up GS-RAM, GS-RAM Plus, or most other IIGs memory cards indefinitely. Should you ever have a "total power failure," RamKeeper switches to its 6-hour battery. When power returns, RamKeeper will automatically recharge the battery to full power. RamKeeper incorporates a dual-rate charger, status L.E.D.'s, and advanced power reducing circuitry. RamKeeper comes *complete* with battery, software, and documentation.

GS-RAM's Got it ALL!

- 5-year warranty — parts & labor
- 6 RAM banks (most cards have 4)
- Memory expansion port
- ROM expansion port
- Ultra-fast disk caching on ProDOS 8 AND ProDOS 16.
- Expands AppleWorks internal limits
- Includes hi-res self test
- No soldered-in RAM chips
- Expandable to 8 MEG
- No configuration blocks to set
- RamKeeper back-up option allows permanent storage of programs & data
- 15-day money-back guarantee
- Proudly made in the U.S.A.

GS-RAM with 256K	\$189
GS-RAM with 512K	\$259
GS-RAM with 1 MEG	\$399
GS-RAM with 1.5 MEG	\$539
GS-RAM with 2.5 to 3.5 MEG	CALL
GS-RAM Plus with 1-8 MEG	CALL
RamKeeper Option	\$179

Order today!

See your dealer or call Applied Engineering today, 9 a.m. to 11 p.m. 7 days. Or send check or money order to Applied Engineering. MasterCard, VISA and C.O.D. welcome. Texas residents add 7% sales tax. Add \$10.00 outside U.S.A.

AE APPLIED ENGINEERING™
The Apple enhancement experts.

(214) 241-6060

P.O. Box 798, Carrollton, TX 75006
Prices subject to change without notice.

NETWORK

The VSETUP utility allocates network resources such as hard-disk space and printers on a class-by-class basis.

VCLASS allows teachers to set up program-access menus for each class and even each student within each class. Students select programs from the menu without ever seeing a native operating system, pathname, or even program name.

COLLECT and DISTRIBUTE are utilities that let teachers collect homework or other documents to be combined, displayed, printed, or distributed to other students.

VCOMM is an electronic-mail and electronic-bulletin-board system that enables students and teachers to communicate with each other individually or in groups within a class or an entire school.

Velan's print service provides spooling for up to 8 printers on the 16-port system. It works with ImageWriter or other dot-matrix printers but not with the LaserWriter.

A VNET workstation can be an Apple II Plus, IIe (enhanced or

not), or even an Apple IIc via its built-in serial port. Macintosh and MS-DOS computers also work with this network, through their built-in serial ports. Apple IIe computers may be diskless workstations and boot either DOS 3.3 or ProDOS 8. IIGS computers cannot currently run ProDOS 16 programs on VNET, but will "soon" be able to.

VNET's main strengths are its classroom-management software, accommodation of workstations using different operating systems, and the ability to attach lots of printers. Also, network performance appears to remain relatively constant even as the number of workstations increases.

One of the weaknesses of this system is that it is based on an IBM PC/AT, which is unfamiliar and perhaps unattractive to many K-12 teachers. Also, cabling for the star configuration is less convenient and more expensive than that of other setups. The added cost of the cables offsets much of the lower

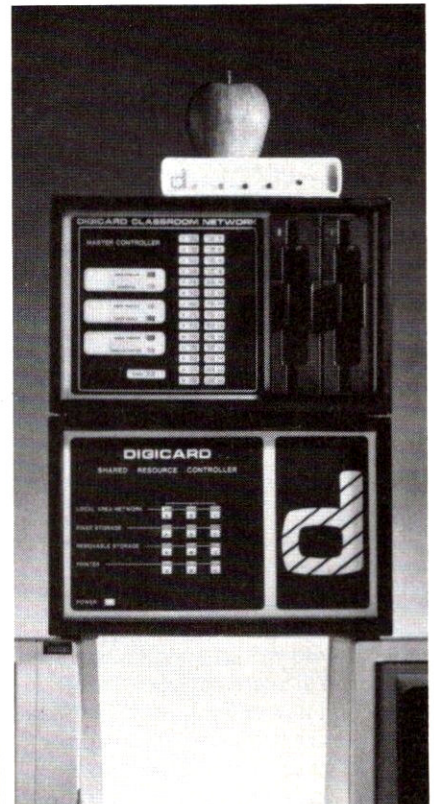

The DigiCard Master Controller (for the Classroom Network) and the Shared Resource Controller (for DNET)

ALL NEW!! Design Your Own Home Architecture, Interiors, Landscape

New Features, New Interface, Same Price!
Work with Apple II+, IIe, IIc, and IIGS. (special IIGS versions coming soon)

All programs now have pull-down menus, and new precision color-fill. And, as always, work with 51 printers.

Architecture

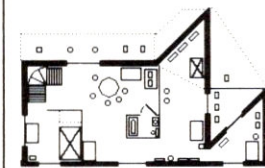

Architecture for all your floor plans, and side-view drawing needs: 4 types of overlays, our fantastic stud/beam repeater function with calculations, plus icons for box, line, circle, ellipse, arc, regular polygons; 1 to 4-screen plans. Includes 154 architectural symbols and fixtures.

Interiors for room and furniture plans: automatic side views, 11 different rotations for each furniture piece. Rearrange, move, explore color schemes, and create custom furniture.

Interiors

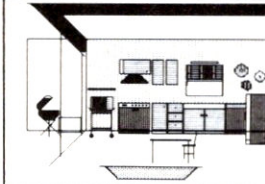

Landscape plans for your property - the easy way: includes top views plus automatic side views from all 4 directions, slopes, aging, two scale options, measurements, and even shopping lists.

Landscape



Architecture, Interiors, Landscape: \$69.95 each. Demo disk: \$10 (add \$3.55 p/h). Updates available. Call for information.

IIGS versions \$89.95 each (plus \$3.55 p/h)

Or see your local dealer.



Abracadata

the source of plan-making software

Dept. A

PO BOX 2440
EUGENE, OR 97402
(503) 342-3030

VISA
MASTER
CARD
AMERICAN
EXPRESS

CIRCLE 227 ON READER SERVICE CARD

POWER PROBLEM?

The Solution!
KALGLO

Computer Grade Power Protection Products

Transient Voltage Surge Suppressors • Power Line Filters
• Power Line Conditioners • Data Line Protectors • FAX/Modem/
Telephone Line Protectors • Standby Uninterruptible Power Systems

1-800-524-0400, in PA 215-837-0700
CALL TODAY FOR FREE LITERATURE

Kalglo Electronics Co., Inc.
6584 Ruch Road
Bethlehem, PA 18017-9359

DEALER-VAR-OEM
INQUIRIES INVITED

CIRCLE 158 ON READER SERVICE CARD

THE NO. 1 MAGAZINE FOR ALL

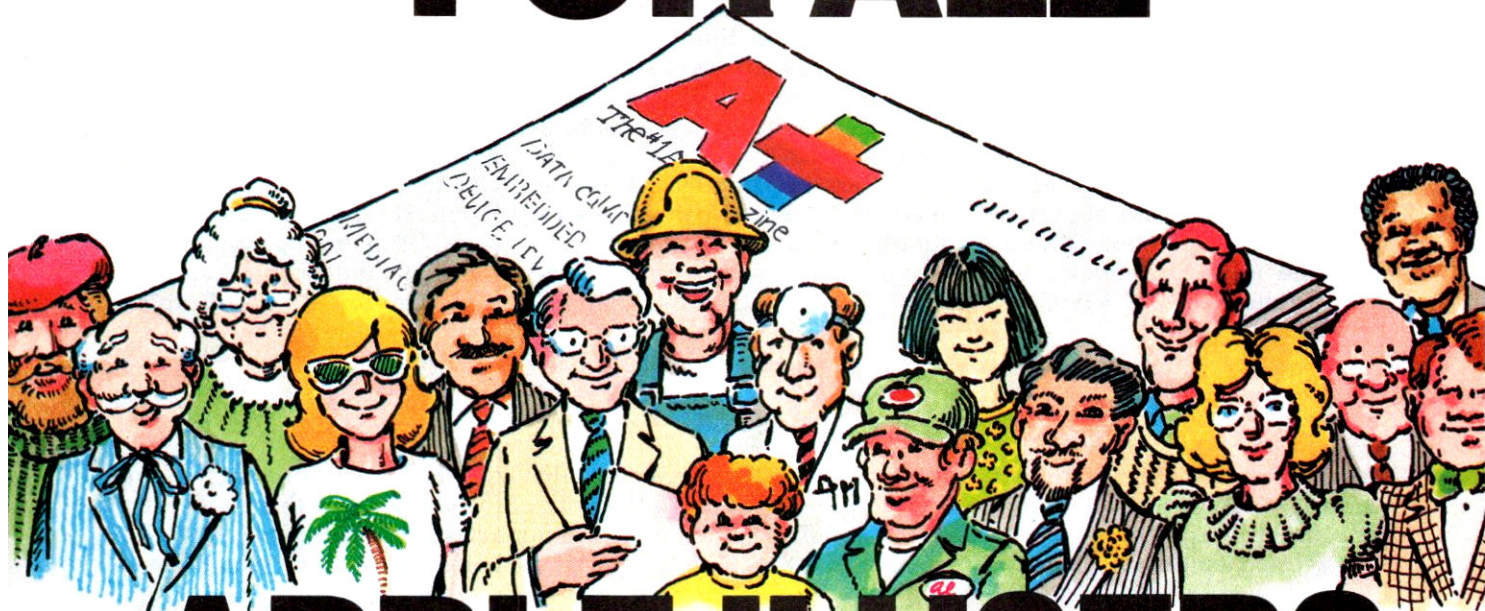

APPLE II USERS

- Because you use an Apple II computer...
- Because you require in-depth product reviews and evaluations...
- Because you want hands-on tutorials...
- Because you need information covering new business, educational and personal applications...

YOU NEED A+ MAGAZINE!

Every issue of A+ Magazine brings you the most complete information on applications,

new products and ways to expand the overall performance of your system. There's no other Apple II magazine as complete and definitive as A+, and there's no better time than now to subscribe to A+ and save 50%!

Enter your subscription to A+ Magazine today and save 50% off the annual single-copy price—that's just like getting 2 issues for the price of 1!

For Fast Service Call 1-800-525-0643

(In Colorado 1-303-447-9330)

Basic annual subscription price is \$24.97.



A+
The #1 Apple II Magazine

NETWORK

cost of the network interface. Also, you can have only one hard-disk drive per server. The transfer rate is among the lowest of all the classroom networks, but it is difficult to compare, since each workstation has a dedicated cable through which to communicate.

Classroom Network and DNET

Major Educational Resources Corporation has approximately 400 network installations in the United States and offers a combination disk/print/boot server called a Digicard Master Controller (\$2495) for use with its Apple II-only Classroom Network. It can connect up to 28 Apple II computers, which can be about ten feet apart from each other. It also has a Shared Resource Controller (SRC), which gives you a hard-disk drive and allows the sharing of three printers. SRCs are available with hard disks with three capacities: 20 (\$2995), 43

(\$4995), and 70 megabytes (\$6995). An SRC allows you to set up DNET, a network for Apple II, Macintosh, and MS-DOS computers.

The technologies of DNET and the Classroom Network differ markedly from each other. The Classroom Network consists of interconnected external Network Interface Units that enable each workstation's disk controller to access the two floppy disks of the Master Controller. This network is the only one in this overview in which users share access to floppy, rather than hard, disks.

DNET is a more traditional multiple-access network that uses internal network-interface cards. The medium is twisted-pair cable with familiar modular phone-jack connectors. The network can be up to 4000 feet long. A DNET can in-

clude up to 32 nodes and provides access to the SRC hard disk.

Each workstation requires either a \$195 Network Interface Unit (for the Classroom Network) or a \$195 DNET interface card. Thus, a five-workstation configuration, not including the price of the workstations themselves, comes to \$3470 for a Classroom Network (two shared floppy-disk drives) or \$3970 for a DNET (a shared 20-megabyte hard-disk drive). Educational organizations typically receive a discount.

The Shared Resource Controller provides a rudimentary disk-serving capability. It can accommodate the widest variety of operating systems, including DOS 3.3, ProDOS 8 and 16, UCSD Pascal, CP/M for the Apple II, and the Macintosh and MS-DOS operating systems. It provides no file-locking capabilities, however. You can attach up to six

NETWORKS AT A GLANCE

This chart shows which computers and operating systems are compatible with the networks covered in this issue of *A+*. Also, we've provided a cost comparison, showing the price of each network with a 20-megabyte hard-disk drive, print-spooling capabilities, and five Apple IIe workstations connected to it. Costs are based on suggested list prices, but actual prices can be lower, with the educational discounts each vendor offers.

	APPLESHARE	OMNINET	ELAN	VNET	CLASSROOM NETWORK	DNET
CPUs						
Apple II Plus		■	■	■	■	■
Apple IIc				■		
Apple IIe	(1)	■	■	■	■	■
Apple IIgs	■	(2)	■	■	■	■
Macintosh	■	■		■		■
IBM-compatible	■	■		■		■
OPERATING SYSTEMS						
ProDOS 8	■	■	■	■	■	■
ProDOS 16	■	■				■
DOS 3.3		■	■	■	■	■
Pascal		■			■	■
CP/M		■			■	■
COST OF A NETWORK						
WITH 5 WORKSTATIONS	\$6371 (3)	\$6453	\$5513	\$6320	\$3470 (4)	\$3970

1. Enhanced IIe only

2. Only at Normal (not Fast) speed

3. In an all-IIgs configuration, the price would be \$995 less because no network cards are required.

4. Floppy-based system

disk drives to the SRC.

Other than a menu-setup utility, no classroom-management or automatic-lesson-collection software comes with the system, but software from two other companies, Ideal Learning and SkillsBank, works with this network.

DNET's print service, with its built-in printer interfaces, provides spooling for up to three printers. The number of spooled documents is limited only by available disk space. The network works with ImageWriter and similar dot-matrix printers only.

The following computers can be workstations on this network: Apple II Plus, IIe (enhanced or not), and IIGS. MS-DOS computers can connect via a DNET interface card, and you can attach Macintoshes through their serial port. This product is, in some ways, the least sophisticated, but it runs the most operating systems and can include the most types of workstations. The floppy-based Classroom Network's "burst load" feature for simultaneous program loading by workstations is very fast.

Weaknesses include the lack of file locking. This system offers no backup capability and is the least sophisticated in terms of system management. +

Rod Williams is a computer consultant who specializes in networks. He lives in Irvine, California.

FURTHER INFORMATION

LanTech
4501 North 22nd Street
Suite 220
Phoenix, AZ 85016
(602) 955-7746

CIRCLE READER SERVICE NO. 380

Velan, Inc.
849 Independence Avenue
Mountain View, CA 94043
(415) 960-3388

CIRCLE READER SERVICE NO. 381

Major Educational Resources
Corporation
10400 Ridgeland Road
Suite 5
Hunt Valley, MD 21030
(301) 628-1527

CIRCLE READER SERVICE NO. 382

Random House
presents

// Write

AppleShare
Version
Network Price
\$269⁹⁵

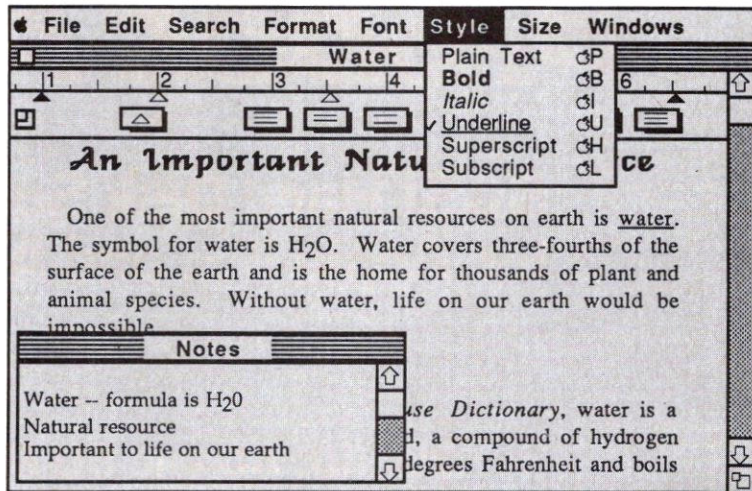

Now Your Students' Papers Can Be Written Like This!

Give The //Write Advantage To Your Students—
Grades 4 to Adult.

- Simple yet powerful word processing**
Pull-down menus, rulers, scroll bars, and dialog boxes make //Write easy to use. True WYSIWYG (What You See is What You Get) lets students see documents on-screen exactly as they will be printed.
- Promotes good writing skills**
Students can use up to four document windows. Keep notes in one window, free write in another, edit and rewrite in a third. Cut and paste between windows as easily as within a single window.
- Helps organize research papers**
Multiple windows enable students to view their notes, organize footnotes, and refer to their bibliography, while writing their final draft.
- Attractive fonts, styles and sizes are ideal for class projects**
Create classroom newsletters, or event announcements.

The Apple II Word Processor with Macintosh Performance

SPECIAL SCHOOL PACKAGE **\$89⁹⁵** includes: 5 1/4" //Write disk, Free backup, Student activities disk, and Teacher's Guide with application worksheets.

To Order or for More Information Call Toll-Free

(800) 638-6460 Ext. 5000

In Maryland (800) 492-0782

In Alaska call collect (301) 848-1900



Random House Media
400 Hahn Road
Westminster, Maryland 21157

System Requirements:

// Write runs on the Apple IIe/c (128K) and Apple IIgs. Requires only one disk drive. All functions can be used with the keyboard or with a mouse.

// Write developed by UNICOM Software Development Group. Apple is a registered trademark of Apple Computer, Inc. Macintosh and Apple IIgs are trademarks of Apple Computer, Inc.

ProDOS Power

SCSI Hard Disk Subsystems for Apple IIgs and Apple IIe

**20, 40, 60 and 80 MB capacities
One year warranty**

BEST PRICE • BEST PERFORMANCE

**Call today for the name and number
of your nearest CMS dealer.**

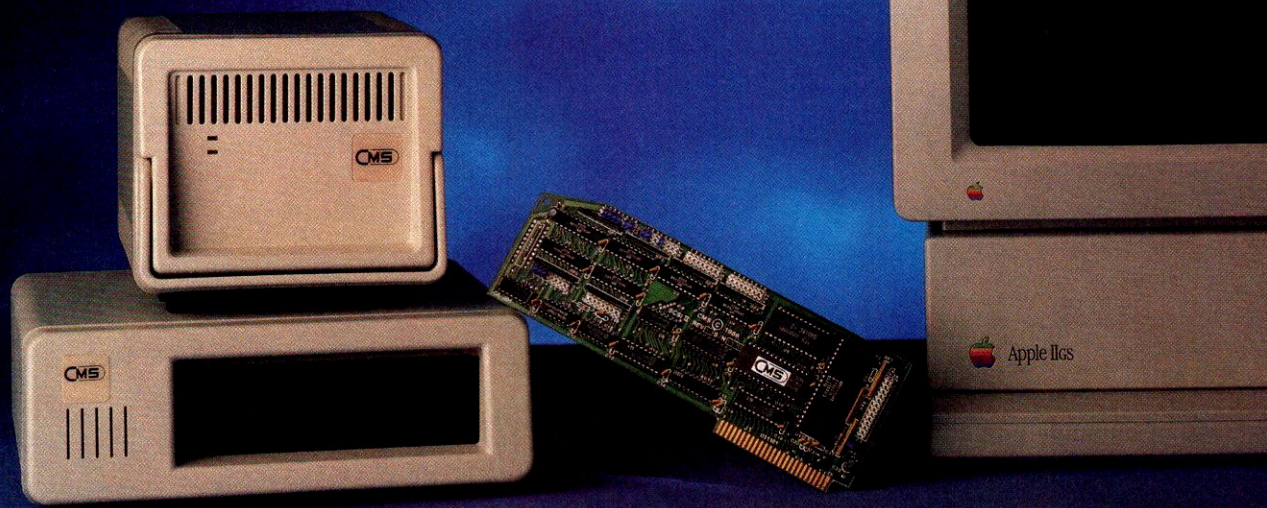

CMS Enhancements, Inc.

1372 Valencia Avenue, Tustin, CA 92680 (714) 259-9555
Telex (023) 371-8711 FAX (714) 549-4004



ProDOS, Apple IIgs and IIe are registered trademarks of Apple Computer Inc.
CMS logo is a registered trademark of CMS Enhancements, Inc.

CIRCLE 300 ON READER SERVICE CARD

Pricing, licensing, and updates

SOFTWARE ISSUES

Setting up a network can involve complex tasks, not the least of which is sorting through the software issues. To get the most out of your network, you might need to buy specialized network software, which is costlier than single-user software and comes with a different sort of license. Perhaps the biggest software issue, though, is upgrading. If you already have, say, five copies of AppleWorks in your computer lab, do you then fork over the full price for the network version, or do you get some kind of price break since you're an existing customer? The answer may not be readily apparent—it depends on the individual software vendor.

Why New Software?

Application software presents challenges on a network because single-user versions may not work properly in a network setting. Many single-user programs are copy-protected, so you won't have much luck getting them installed on the network's hard disk. Even unprotected programs can cause difficulties, because it's one thing to be able to install software on the network and another to get it to cooperate when several people are trying to use it at once. Network applications typically have intelligence that prevents users from working on the same files at the same time. (In classrooms, life can be further complicated by the need for curriculum-management software. See "Teachers' Toolbox" in this issue for details.)

Paying the Price

One reason network software costs more is because it's more so-

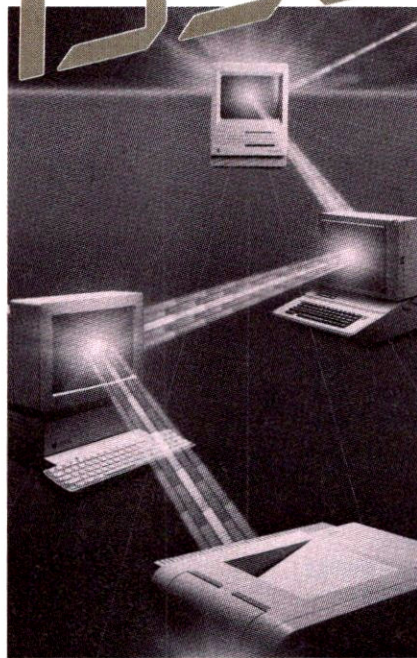

phisticated and harder for publishers to support than single-user versions. How much more does it cost? Typically, a network application package runs three to five times the price of a single-user version. (Of the 11 companies we interviewed for this article, the extremes were Temporal Acuity, which is charging 2½ times the single-user price for its network software, and Claris, charging 6½ times the single-user price of AppleWorks.)

The main reason, though, that vendors charge more for network versions is that more than one person uses the software. Publishers easily justify a 400% cost markup, assuming that you'll have as many as 10 or 15 or 20 users sharing the same program. (In fact, none of the companies we surveyed for this ar-

ticle place any limit on the number of users you can have—see below.)

Licensing of network software is generally pretty straightforward. We interviewed the 11 companies that Apple Computer told us were developing products for the AppleTalk network, and most of them said they would simply sell network versions separately from the single-user versions. The network license allows purchasers to install the software on a single file server and lets an unlimited number of workstations access that software, as long as those workstations are connected to that file server, not gaining access through a bridge from another network.

A couple of companies, though, have a different approach to licensing. MECC, for instance, likes to deal with school districts rather than individual buyers and offers its customers "memberships" that entitle a district to make as many copies of a product as necessary, with the price based on the district's enrollment. Logo Computer Systems, Inc., prefers to work with individual schools and offers a site license for its LogoWriter for the AppleTalk network. In this case, the \$450 license agreement covers all the file servers in the school.

Upgrade Paths

The least-defined issue pertaining to networking software is upgrading. Most of the companies told us that they would offer some kind of upgrade path but didn't have the details ironed out by the time we went to press. Here are the ways that different companies say they'll handle it:

SOFTWARE FOR APPLE TALK

Here's the list of companies developing software for the AppleTalk network that Apple Computer, Inc., gave us at the beginning of February 1988. It includes specific titles that they are modifying for use with AppleTalk. Undoubtedly, many more companies have commenced AppleTalk development since then, but this list should give you an idea of the breadth of products that will soon be available in network versions.

CLARIS CORPORATION 440 Clyde Avenue Mt. View, CA 94043 (415) 960-2688	APPLEWORKS	Integrated word processing, database management, and spreadsheet
HARBOR SOFTWARE 403 Great Road, #8 Acton, MA 01720 (617) 263-1870	MOUSEFILER	Utilities
LOGO COMPUTER SYSTEMS, INC. 1000 Roche Blvd. 9th Floor Vaudreuil, Quebec Canada J7V 6B3 (514) 455-5636	LOGOWRITER	Integrated word processing, graphics, and programming
MECC <i>Approximately 100 of MECC's 300 educational titles</i> 3490 Lexington Avenue North St. Paul, MN 55126 (612) 481-3560		
MILLIKEN 1100 Research Road P.O. Box 21579 St. Louis, MO 63132 (314) 991-4220	THE FIRST "R"	Reading
PINPOINT PUBLISHING 5865 Doyle Street, #112 Emeryville, CA 94608 (415) 654-3050	PROFILER LET'S TALK POINT-TO-POINT DOCUMENT CHECKER	Database management Electronic mail and bulletin board Telecommunications Word-processing enhancement
SCHOLASTIC 730 Broadway New York, NY 10003 (212) 505-3000	BANK ST. WRITER III WITH ELECTRONIC MAIL AI ALGEBRA SHOP MATH SHOP TALKING TEXT WRITER MULTISCRIBE GS SUPERPRINT <i>Scholastic has announced that it intends to also make the rest of its product line compatible with AppleTalk.</i>	Word processing Logic Math Math Word processing Word processing Banner and sign making
STONE EDGE TECHNOLOGIES P.O. Box 200 Maple Glen, PA 19002 (215) 641-1825	DB MASTER VERSION 5 DB MASTER PROFESSIONAL	Database management Database management
SUNBURST COMMUNICATIONS Washington Avenue Pleasantville, NY 10570 (914) 769-5030	ANT FARM BOUNCE! GEOMETRIC PRESUPPOSER 39 GEOMETRIC PRESUPPOSER: CIRCLES GEOMETRIC PRESUPPOSER: QUADRILATERALS GEOMETRIC PRESUPPOSER: TRIANGLES MUPPET WORD BOOK MUPPETS ON STAGE MUPPETVILLE SUPER FACTORY	Problem solving Problem solving Math Math Math Math Reading Prereading Basic skills Problem solving and math
TEMPORAL ACUITY <i>20 music-education titles</i> 300—120th Avenue NE, Bldg. 1 Bellevue, WA 98005 (206) 462-1007		
TML SYSTEMS 8837-B Goodbys Executive Drive Jacksonville, FL 32217 (904) 636-8592	TML PASCAL TML BASIC	Programming language Programming language

A Comparison Between the #1 Maker of Apple Memory Cards (Applied Engineering) and the #2 Maker (Apple Computer)

FOR THE IIc			FOR THE IIgs			FOR THE IIc		
	RamWorks III®	Apple's™ Card		gsRAM™ gsRAM Plus™	Apple's™ Card		Z-RAM Ultra™	Apple's™ Card
Maximum Desktop	3017K	1012K	Maximum Desktop	8000K	1012K	Compatible with All IIc's	YES	NO
Maximum Number of Records in Database	22,600	6350	Maximum Number of Records in Database	22,600	6350	Maximum Desktop	727K	1012K
Maximum Number of Lines in Word Processor	22,600	7250	Maximum Number of Lines in Word Processor	22,600	7250	Maximum Number of Records in Database	22,600	6350
Maximum Clipboard Lines	2042	255	Maximum Clipboard Lines	2042	255	Maximum Number of Lines in Word Processor	22,600	7250
Autoloads All of AppleWorks	YES	NO	Autoloads All of AppleWorks	YES	NO	Autoloads All of AppleWorks	YES	NO
Multiple Disk Save	YES	NO	Multiple Disk Save	YES	NO	Multiple Disk Save	YES	NO
Built-in Printer Buffer	YES	NO	Built-in Printer Buffer	YES	NO	Built-in Printer Buffer	YES	NO
Compatible with All Versions of AppleWorks	YES	NO	Displays Time & Date on AppleWorks Screen	YES	NO	Compatible with All Versions of AppleWorks	YES	NO
Displays Time & Date on AppleWorks Screen	YES	NO	Time and Date Macros	YES	NO	Displays Time & Date on AppleWorks Screen	YES	NO
RGB Option	YES	NO	3.5 Disk Cache	YES	NO	16 Bit Co-Processor Port	YES	NO
16 Bit Co-Processor Port	YES	NO	Built-in Hi-Res Diagnostics	YES	NO	Built-in Hi-Res Diagnostics	YES	NO
Built-in Hi-Res Diagnostics	YES	NO	Memory Expansion Port	YES	NO	Built-in ProDOS, DOS 3.3 Clock	YES 1	NO
Memory Expansion Port	YES	NO	ROM Expansion Port	YES	NO	Built-in CP/M Capability	YES 2	NO
80 Columns Built-in	YES	NO	Number of RAM Banks	6	4	Maximum Total Functions	5	1
Maximum Total Functions	6	1	Maximum Memory on Main Card	1.5 or 6 MEG	1 MEG	Software Standard	YES	YES
Software Standard	YES	YES	Software Standard	YES	YES	Made in	USA	Singapore
Made in	USA	Singapore	Made in	USA	Singapore	Warranty	5 years	90 days
Warranty	5 years	90 days	Warranty	5 years	90 days			

Apple makes good peripherals for their computers. Perhaps that's why they sell more monitors, printers, disk drives and other accessories for their computers than anyone else. Well, almost anyone else. You see, Applied Engineering is the only company to outsell Apple in the peripheral business. In fact, according to several independent studies we outsell them 2 to 1. Why? Are Apple's memory cards not up to par? No, actually they're just as good as their other peripherals, it's just that ours are a generation ahead. And we outperform all other memory cards in a similar way.

One look at the chart above will tell you why most Apple owners choose Applied Engineering when they want to

expand their Apple's performance.

You can find the number 1 memory cards for the Apple at over 2,000 Applied Engineering dealers worldwide. Call 214-241-6060 for the dealer nearest you or to place an order.

AE APPLIED ENGINEERING™
The Apple enhancement experts.

P.O. Box 798, Carrollton, TX 75006 (214) 241-6060

1) Only on Ultra 2 or 3, 2) only on Ultra 3

NETWORK

•Sunburst says it will let customers of single-user versions trade up to the network release by paying an additional price of two times the single-user cost (all of Sunburst's networked products will cost three times the price of the individual version). Harbor Software will probably offer a similar plan, allowing customers to trade in single-user versions of MouseFiler and pay the difference between the

single-user price (\$69.95) and the network price (\$199.95). Stone Edge Technology says it's also considering the same type of arrangement, pricing the upgrade close to the difference between the price of the single-user and network versions of DB Master, Version 5. And Temporal Acuity says it's likely to take the same approach with its

music-education titles.

•MECC offers its membership customers the opportunity to simply buy the network "loader" at an additional cost, rather than swap for a whole new version. The expense, again, depends on the size of the school district.

•Scholastic Software says it "will offer an upgrade" but didn't have any details at press time. TML Systems and Claris Corporation say essentially the same thing, although Claris adds that it will have "a special policy for users who have multiple copies."

•Pinpoint says it will probably offer some kind of temporary promotion to move customers of its single-user products up to network versions.

•Logo Computer Systems, Inc., gives buyers of its single-user software a nine-month period during which they can upgrade to the network version for a discount. After that, they must pay the full price.

•A representative from Milliken says the company "hasn't really decided that issue." With Milliken it's not such a critical matter, though, because the program the company is releasing for the network (The First "R") is a new product even in the single-user version, so no huge installed base of users is concerned about upgrading.

The Bottom Line

As you can see, upgrading is the great gray area in software networking. Particularly confusing will be situations in which a user has lab packs or just multiple, single-user copies of a program and wants to swap them for a network version.

By the time this issue of *A+* appears, companies that are new to networks will have a better idea of what their policies will be, so we recommend that you check with them and press the issue. (Claris, for instance, suggests you call its upgrade number—[800] 544-8554—for details.) If the companies haven't decided, they'll need to do so soon to keep their customers satisfied. Your best bet is to ask a lot of questions before taking the network plunge. +

Lisa Raleigh is the executive editor of A+ magazine.

You need
the ultimate
educator lab...

ELAN

... Networking
at its simplest

by
**LAN
TECH™**

11811 N. Tatum Blvd., Suite P150
1-800-522-0666 • Phoenix, Arizona 85028 • 602-953-6300
Designed for the Apple II Educational Environment.

DOS AND ProDOS

APPLE II FILE SERVER

FILE LOCKING

UP TO 128 STATIONS
with 100 Meg. Hard Disk Storage

PUBLIC AND PRIVATE FILES

MULTIPLE PRINTERS

PRINT SPOOLING

PASSWORD SECURITY

CIRCLE 199 ON READER SERVICE CARD

Introducing Powerful Desktop Publishing for the Apple IIGs™

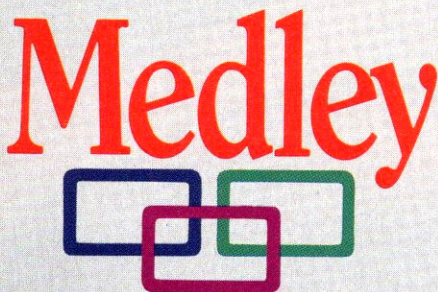

One integrated program that does everything

- Word Processing
- Page Layout
- Graphics

Available now ...from Milliken

At last. Simple Mac-like desktop publishing that takes full advantage of the IIGS. Instead of juggling multiple disks and software, Medley lets you create sparkling documents with a single program. Medley does it all, beautifully.

Experience the creative power of Medley for yourself.

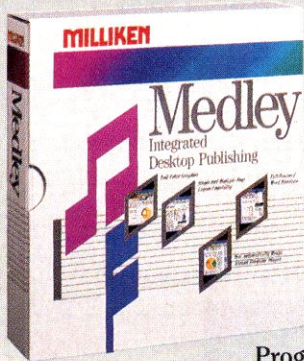

It's available now at a price you can afford.

Medley includes:

- One desktop publishing disk with back-up
- One 80,000 word dictionary thesaurus disk
- One Clip art disk with over 500 graphics
- Medley user's guide

Program price, complete—\$195⁰⁰

FREE BONUS. Order by June 1, 1988 and you'll receive a Free Disk with sample style sheets to help you add a professional touch to your layouts. Act now to receive this valuable bonus.

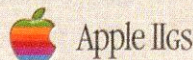

For FREE CATALOG or to place an order call 800-643-0008, or mail this coupon to:

Milliken Publishing Company, 1100 Research Blvd.,
St. Louis, MO 63132-0579. (314) 991-4220

Name _____

Organization _____

Address _____

City _____ State _____ Zip _____

Telephone () _____ () Please Call me

MILLIKEN

CIRCLE 250 ON READER SERVICE CARD

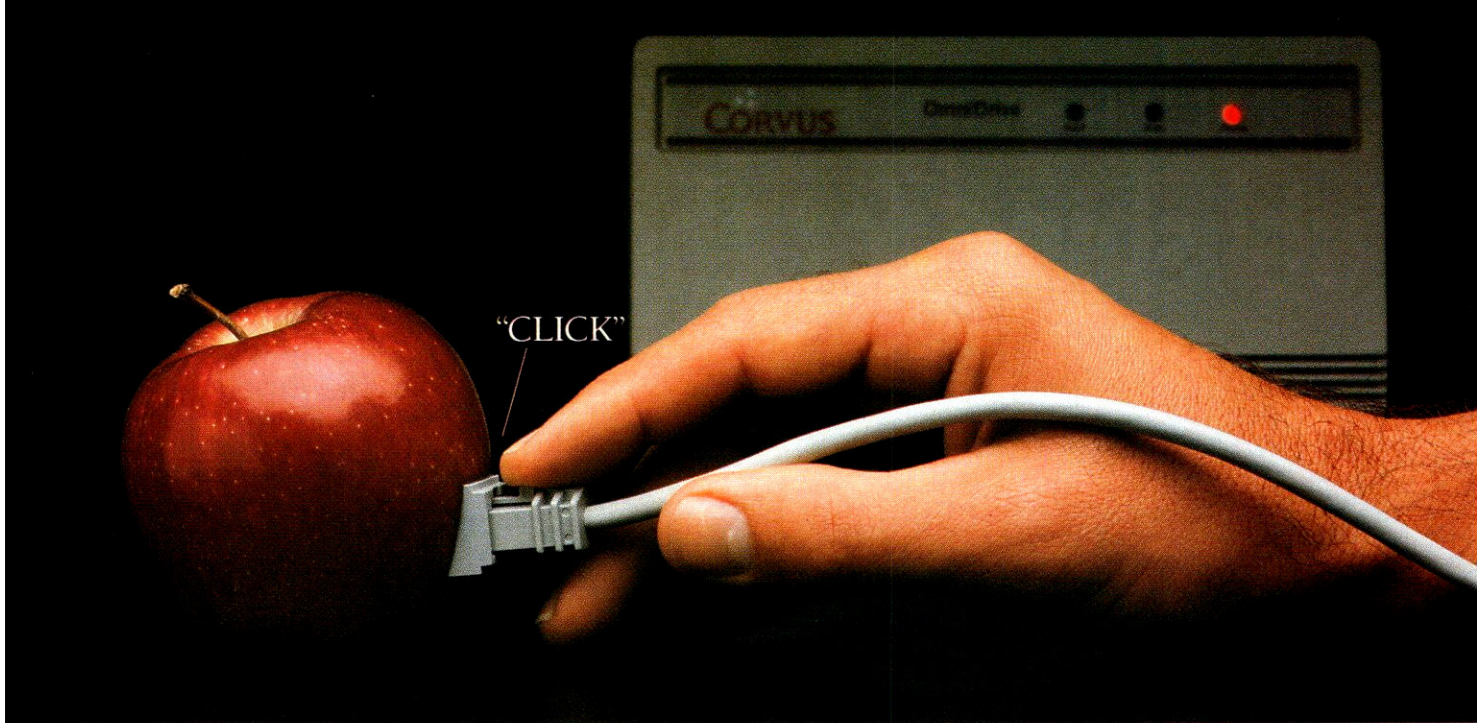

...You've just networked your Apples to the world's largest library of educational software.

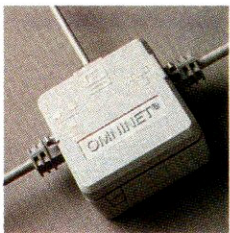

Choose Corvus products and you'll be able to run over 2000 different programs from over 70 of the top educational software publishers.

A Corvus network not only runs DOS 3.3, ProDOS, MS-DOS, Macintosh, CP/M and Pascal-based programs in standalone and managed formats—it runs them *simultaneously!*

Corvus ties *all* your machines—Apple, Macintosh, IBM, Tandy, and PC clones—into one simple network that's fast and easy to use.

And we've made loading software and managing student programs easier too, with a network management system designed specifically for educators.

No one knows networks like our Corvus dealers. They've installed over 11,000 Corvus systems in schools nationwide. They have the experience it takes to make your computers more

productive and more cost effective. And their after-sale support insures that your school will get the most out of its network, every class period, everyday.

FREE SOFTWARE CATALOG AND VIDEO

Corvus networks give teachers more time to teach, and students more time to learn. Our video shows how. And our software catalog lists thousands of networkable programs from all the top publishers of educational software. To get the video free for thirty days, the catalog and the name of your nearest dealer, mail this coupon or call Control Data at 1-800-451-2186.

Please send me your **FREE VIDEO** for 30 days, and your free software catalog.

Name _____

Title _____ School _____

Address _____

City/State/Zip _____

Phone _____ Best time to call _____

Mail to: Control Data, Dept. BLCW3A
8800 Queen Ave., South, Bloomington, MN 55431

A+588

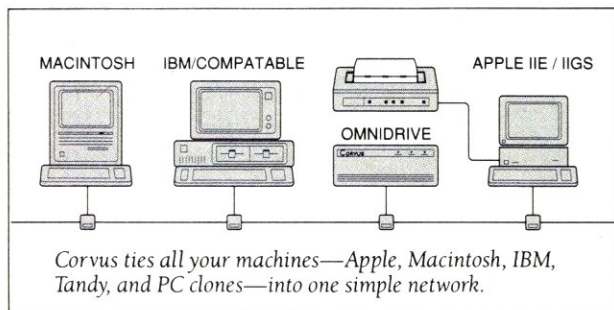

CIRCLE 164 ON READER SERVICE CARD



Control Data and its dealers are the exclusive resellers of Corvus products in the K-14 Education market

Registered trademarks: Apple, Macintosh, ProDOS, Apple Computer, Inc.; IBM, PC, International Business Machines; Tandy, Tandy Corporation, MS-DOS, Microsoft Corporation, CP/M, Digital Research

©1988 Control Data

monplace, software developers will feel free to create larger programs, since they will no longer be constrained by disk size.

ICON's writing program is undergoing an extension that will increase its size to several hundred megabytes. The program will be distributed on CD-ROM disks, each of which can hold 550 megabytes of information.

Educational file servers will probably be enhanced to provide program libraries and reference material on CD-ROM and will use traditional hard-disk technology to record class-generated files and records. To see the impact that such a setup could have, consider that each CD-ROM's 550 megabytes equals about 250,000 typewritten pages of text. Audio CD players are available for a few hundred dollars that can handle six compact discs at a time, so similar players are likely to evolve for CD-ROM. If so, each player could hold the equivalent of 1,500,000 pages of information, any word of which could be accessed within a few seconds. Now imagine that these disks contained the great works—Plato, Aristotle,

Disk failures on a network are generally catastrophic.

Lao Tzu, Shakespeare, the Bible, and so forth. A writer looking for a certain quote could find it quickly and could also browse through the surrounding material to see the context in which the quoted passage appeared. Reference material of this sort could be located in a central file server, where anyone who needed to see it could access it.

The Bad News

The first piece of bad news (as any owner of a hard-disk drive already knows) is that no matter how much disk space you buy, it isn't enough. Parkinson's Law ("Expenditure rises to meet income") applies to disk storage as well as to anything else in life. I have a 20-megabyte drive on my computer that holds only "essential" stuff. Within a month of buying the drive, I had filled 13 megabytes of space, and I now am lucky if I have more than 2 megabytes free. If I went to a 40-megabyte drive, I'd

probably fill the disk in a month.

Disk failures on a network are generally catastrophic. Since the restoration of a 20-megabyte hard disk takes about an hour (assuming you remembered to make a backup), a crash of the file server can essentially shut a school's computers down for the day.

A related issue: Who is going to maintain and control the network? Most schools haven't the resources to fund education properly, let alone fund equipment maintenance. You can't expect teachers to add "network czar" to their title without getting some release time to make sure everything is going properly. To get a glimpse of what can happen, talk to people who maintain an electronic bulletin board in their "spare time." It's not a pretty job!

The Complex News

Educators and administrators who think that a network will allow them to serve all their computers for the price of a single piece of software are in for a rude awakening. Software is usually sold like books—one copy per reader.

Software vendors feel abused by

TOTAL INVOLVEMENT

With The **LANGUAGE EXPERIENCE RECORDER** ^{Plus}
Featured in *Only The Best* Lifetime Warranty
30 Day Preview Apple II
Networking Available

An integrated, whole-language approach to reading and writing providing students with the opportunity to write and read their own experience or imaginary stories. Special features include:

- 20-40-80 column display
- 20-80 column & banner print
- stories read aloud with Slotbuster or Echo
- story analysis giving total words, unique words, average word & sentence length and readability
- cumulative word list and frequency distribution

P.O. Box 7130 • Gainesville, FL 32605-7130

Teacher Support
SOFTWARE

1-800-228-2871

IN FLORIDA
(904) 371-3802

THE ONLY NETWORKING SYSTEM YOUR CLASSROOM WILL EVER NEED!

The "NETPLEXER II"

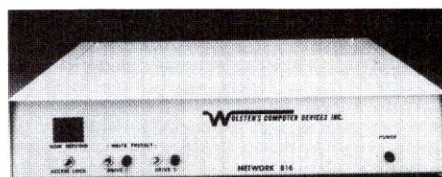

Finally an economical classroom networking system that doesn't require a Ph.D to operate. The patented Wolsten's NETPLEXER II is the simplest, state-of-the-art classroom networking system, and it is available for immediate shipment.

Designed for Apple IIgs and IIe computers, NETPLEXER II shares one to four programs with up to 64 computers, all loading simultaneously or sequentially. Compatible with almost all Apple software, protected and interactive. No modification to the software is required. Works with 5.25", 3.5" and hard drives, plus 2 local drives. Printer spooling for ImageWriter or other printers is available. System is endorsed by most software companies.

For more information, or for the name of your nearest local dealer, call or write:

WOLSTEN'S
wolsten's computer devices inc.

Wolsten Building, 99 Washington Street, East Orange NJ 07017
Phone 201-678-0008 or 800-338-1153, Fax 201-678-3054

CIRCLE 217 ON READER SERVICE CARD

CIRCLE 197 ON READER SERVICE CARD

*Most schools haven't
the resources to fund
education properly,
let alone fund
equipment
maintenance.*

schools that buy one copy of a program and then make copies for distribution to many teachers. If the physical act of making a copy causes pangs of conscience in educators, this cue is absent once a program is installed on a fileserver. In principle, anyone connected to the fileserver has access to any program saved there. The opportunities for abuse are tremendous.

On the other hand, it is unfair for a vendor to base the price of its software on the total number of computers in a network if only a few of those computers use the program at any one time.

One solution to this dilemma is for software developers to establish a pricing policy that keeps track of multiple loadings. A program can be priced to run on any number of computers, from one on up to the network limit. For example, suppose a program comes with a five-unit license. If all five copies of the program are in use and more users want the program, they will get a busy signal until someone else's copy is released. Multiple loadings are fairly easy to monitor, and a policy of this sort may work in the best interests of educators and developers alike. (For other approaches to multiple-use licensing, see "Teachers' Toolbox" and "Software Issues: Prices, Licensing, and Updates" elsewhere in this issue.)

My fear is that, unless we find some equitable way to meet the legitimate needs of schools and software developers, commercial software support for educational networks will be modest at best.

We should take the time now, while educational networks are still in their infancy, to resolve this issue in a way that will increase the power and capability of the computers in our classrooms.

If we meet these challenges fairly, we may never hear the grinding sound of an Apple II disk drive again! +

TML BASIC

for the APPLE IIGs

Introducing TML BASIC, a modern, 16-bit BASIC stand-alone compiler designed specifically for the Apple IIGs. TML BASIC is an integrated, full-screen programming environment which uses the mouse, pull-down menus, windows and more. TML BASIC allows you to create stand-alone ProDOS16 applications, and provides complete access to every IIGs Toolbox routine, including Super Hi-Res Graphics, Menus, Dialogs, Windows, and Sound using TML BASIC's predefined libraries.

- Creates stand-alone applications in seconds without leaving TML BASIC's environment.
- Advanced statements like PRINT USING, IF/THEN/ELSE, DO/WHILE/UNTIL and more ...
- Built-in debugger detects and highlights run-time errors.
- Incredible compilation speed retains the interactivity of an interpreter.
- Allows for user defined procedures and functions using parameters, local variables and recursion.
- Compiles GS BASIC programs.
- Requires only 512K total memory and one 3.5" disk drive. \$125.00.

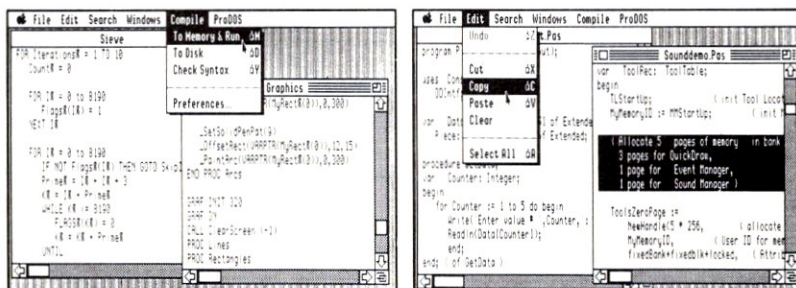

TML Pascal

for the APPLE IIGs

TML Pascal is the most powerful programming language available for the Apple IIGs. TML Pascal enables you to write, edit, compile and run applications and desk accessories with incredible speed and simplicity without ever leaving the TML Pascal environment.

- Implemented in the same integrated environment as TML BASIC.
- Provides complete access to the IIGs Toolbox using predefined libraries.
- Test drive an evaluation copy of TML Pascal at any Apple dealer.
- Creates stand-alone ProDOS16 applications as well as Classic and New Desk Accessories.
- Conforms to ANSI & UCSD standards.
- Requires only 768K total memory and one 3.5" disk drive. \$125.00.

Additional TML BASIC and TML Pascal Products

TML Speech Toolkit lets you add computer-generated speech to your BASIC or Pascal programs. Requires just 512K total memory. \$69.00
TML Source Code Library is an extensive collection of over 20 example Pascal programs designed to assist the Pascal programmer. \$49.00



TML Systems, Inc.
8837-B Goodbys Executive Drive
Jacksonville, Florida 32217
Call (904) 636-8592 MC VISA COD



A N N O U N C I N G

The **A+** SECOND ANNUAL

'HOW I USE THE

Share your Apple II teaching success stories with *A+* magazine, and you may win a complete Apple IIgs computer system or hundreds of dollars' worth of Apple II software!

October is Computer Learning Month, and *A+* magazine is celebrating by again sponsoring the popular "How I Use the II to Teach" contest. If you've discovered innovative ways to teach with Apple II computers, *A+* wants to hear from you! Send your Apple II teaching success stories by July 15, 1988 to: II to Teach, *A+* magazine, 950 Tower Lane, 18th Floor, Foster City, CA 94404.

All entries must be 500 words or less in length, type-written, and double-spaced. And make sure your entry includes your name, address, telephone number, and the name of the category you are entering.

Two Winning Categories: Regular Classroom and Special Education

REGULAR CLASSROOM TEACHERS:

Share with us your successes, using any Apple II computer, in teaching a group of students (two or more) in public or private primary or secondary schools and colleges/universities. Entries can also be in adult continuing education or even in corporate training.

Tell us about the creative ideas and effective methods you've used with the help of your Apple II that have produced noticeable results from your students.

SPECIAL EDUCATION TEACHERS:

Share with us *your* successes, using any Apple II computer in any educational setting, teaching special students who are emotionally, intellectually, or physically challenged. Tell us how your innovative thinking and creative use of an Apple II have inspired your students to new levels of learning and achievement.

A+ will award a Grand Prize and First, Second, and Third Prizes in each of two separate categories of en-

tries—Regular Classroom and Special Education—for a total of eight exciting, high-value prizes! The Grand Prize is an Apple IIgs computer from Apple Computer with GS-compatible peripherals from the following leading hardware companies:

■ Applied Engineering ■ Bose ■ Electronic Learning Systems ■ Kensington Microware.

First, Second, and Third Prizes are \$400, \$300, and \$200 worth of Apple II software from these prominent software publishers:

■ Accolade ■ Activision ■ Addison-Wesley Publishing ■ Baudville ■ Blue Lion Software ■ Britannica Software ■ Brøderbund Software ■ Compu-Teach ■ DataSoft ■ Davidson & Associates ■ Educational Resources ■ First Byte ■ Great Wave Software ■ HBJ Publishing ■ Heartsoft ■ Jada Graphics ■ Mastery Developments ■ Milliken Publishing ■ Mindscape ■ Penguin/Polarware ■ Random House Media ■ Scholastic Software ■ Sensible Software ■ Sequential Systems ■ Springboard Software ■ Stone & Associates ■ StyleWare ■ Sunburst Communications ■ Teachers Support Software ■ The Learning Company ■ The Software ToolWorks ■ Thunderware ■ Timeworks, Unison World ■ Weekly Reader Software/Optimum Resource.

Start writing your Apple II success stories today, and you could win hundreds of dollars' worth of software or the Apple IIgs system of your dreams!

***Hurry! Entries must be postmarked by
July 15, 1988, and received by A+
no later than July 21, 1988.***

II TO TEACH" CONTEST

"How I Use the II to Teach" Official Contest Rules

NO PURCHASE NECESSARY

1. All entries must be 500 words or less, typed and double-spaced. Multiple entries, mailed in separate envelopes, will be accepted. On each entry include your name, address, daytime telephone number, and the name of the category you are entering (Regular Classroom or Special Education). The publisher of *A+* magazine will have the right to publish any entry in *A+* magazine and in any collection of entries.

Mail completed entries to: "II to Teach" Contest

***A+* magazine
950 Tower Lane, 18th Floor
Foster City, CA 94404**

Entries not fulfilling the above requirements will be disqualified.

2. Contest begins April 15, 1988, and is promoted and advertised in *A+* magazine and related publications. All entries must be postmarked by July 15, 1988, and received no later than July 21, 1988. All decisions will be made by September, 1988, and winners will be announced in the November issue of *A+*.

3. For each category there will be a total of four prizes awarded as follows:

Grand Prize: Complete Apple IIgs computer system

1st Prize: \$400 worth of Apple II-compatible software

2nd Prize: \$300 worth of Apple II-compatible software

3rd Prize: \$200 worth of Apple II-compatible software

4. Winners will be selected by a panel of industry experts and *A+*

magazine editors from all submissions that meet entry requirements. Decisions will be based equally upon content, originality, practicality, and results of educational applications described. The judges' decisions are final.

5. The *A+* "How I Use the II to Teach" contest is open to all individuals of at least 18 years of age who are residents of the U.S., its territories and possessions, with the exception of employees (and their families) of Ziff-Davis Publishing Company and its properties, and their advertising and promotion agencies. Void where prohibited or restricted by law.

6. For a complete winners' list, send a stamped, self-addressed envelope to: *A+* magazine, "II to Teach" Contest, 950 Tower Lane, 18th Floor, Foster City, CA 94404. Refer to the November, 1988 issue of *A+* magazine for winners' names.



AppleWorks Is Great!

But...

Let's face it. AppleWorks is a great program, but as a data base manager it leaves a lot to the imagination. Like, imagine more than 30 categories per record. (Lots more!) And using up to 30 screens in the single record display. Or scrolling left and right to see more fields in a multi-record display. And entering up to 250 characters per category.

ACE REPORTER

Imagine printing reports in almost any form: multiple-across mailing labels, columnar reports, mail-merge letters. Even complex forms like school or medical records or invoices. Reports that include free-form text, and printstyles like bold, large and underline, and every easy-to-use formatting option you're ever likely to need.

FORMULAS FOR SUCCESS

Imagine calculated categories—lots of them. Not just in reports, but within the records themselves, too. Using multiple levels of parentheses, and date math and string comparisons and other functions. Imagine reports with calculations based on subtotals and totals. Reports that can even group records by week, month, calendar quarter or year.

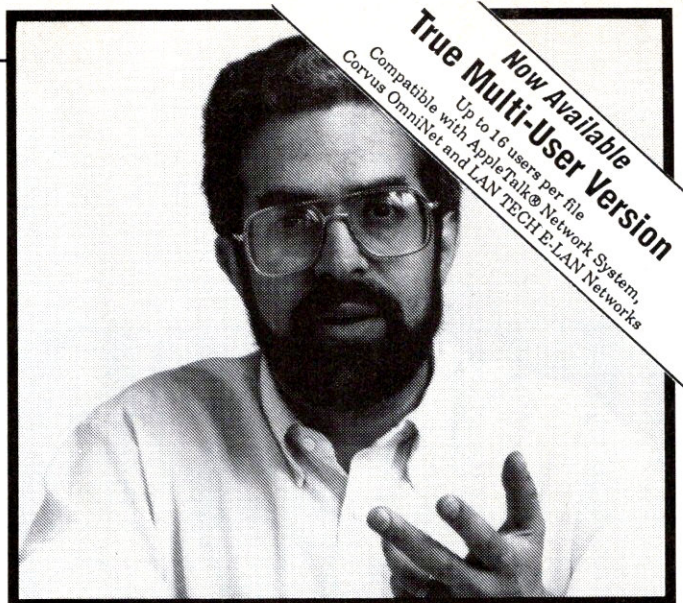

Barney Stone

Designer, DB Master

Now Available
True Multi-User Version
Up to 16 users per file
Compatible with AppleTalk® Network System,
Corvus OmniNet and LAN TECH E-LAN Networks

RELATIONAL? SENSATIONAL!

And if that's not enough, imagine a *relational* data base manager. One that does automatic look-ups and posting. Imagine an invoice file that looks up customer names and addresses in a customer file, then descriptions and prices in an inventory file, then posts quantities shipped and back-ordered back to the inventory file, and finally posts the amount due to the appropriate record in the customer file. Imagine doing this easily, without any programming.

RECOMBINANT DBM

Is your AppleWorks data split into several files? Imagine combining them into one convenient file. Do the AppleWorks files have different categories, so each record in one file has a corresponding record in the other file? And they really should have been a single record, but there were too many categories? Imagine combining them properly, so the information that belongs together is in one record.

DREAM ON!

Imagine that all of this, and much, much more, is available **right now**, in DB Master Version Five and DB Master Version Five *Professional*.

Sometimes wishes do come true!

DB Master vs. AppleWorks

Features and Maximum Capacities	AppleWorks	DB Master Version Five	DB Master Version Five Professional
■ RELATIONAL IMPORT (look-up) and EXPORT (posting) RULES	No	No	YES!
■ fields (categories) per record	30	200	200
■ max. record length (bytes)	1,024	2,000	2,000
■ screens per record	1	30	30
■ characters per field (category)	76	250	250
■ RAM or disk based?	RAM	Disk (1)	Disk (1)
■ passwords for file security	No	No	Yes
■ required fields	No	No	Yes
■ field validation rules	No	No	Yes
■ criteria per search or select	3	20-50	20-50
■ computed values within records	None	99 (2)	99 (2)
■ computed values per report	3	50 (2)	50 (2)
■ date calculations	No	Yes	Yes
■ field types	3	13 (3)	13 (3)
■ automatic date and time fields	No	Yes	Yes
■ current mon/day/year searches	No	Yes	Yes
■ report formats per file	8	255	255
■ multiple-across mailing labels	No	Yes	Yes
■ forms-style reports	No	Yes	Yes
■ report lines per record	15	255	255
■ calculations based on subtotals	No	Yes	Yes
■ free-form text in reports	No	Yes	Yes
■ print fields and/or free-form text in various printstyles	No	Yes (4)	Yes (4)
■ print simple bar graphs	No	Yes	Yes
■ multiple levels of header and footer lines for reports	No	Yes	Yes
■ include fields in header and footer lines	No	Yes	Yes
■ multiple levels of group subtotals in reports	No	Yes	Yes
■ add and/or delete fields without losing report formats	No	Yes	Yes
■ works with RAM disks	Yes	Yes	Yes
■ copy protected?	No	No	No

(1) up to 50 disks per file, 5 1/4", 3 1/2" or mixed; up to 10 megabytes per file on hard disk
 (2) use . * / > < < > AND, OR, NOT, SQR, ABS, SGN, INT, MIN, MAX, up to 7 levels of parenthesis; text comparisons, days-between dates, calculated dates, special "Current Date" function, etc.
 (3) text, 3 numeric types, \$/cents, yes/no, date, add date, edit date, add time, edit time, user-defined, label
 (4) underlined, bold, compressed, large, italics and user-defined print styles; depend on printer's capabilities

DB MASTER® VERSION FIVE

The Ultimate Data Base Manager
for the Apple //

Requires Apple //e (enhanced with extended 80-column card), //gs, //c or Laser 128. At least two 5 1/4" floppy disk drives, or any combination of 5 1/4" and 3 1/2" floppies, ProDOS compatible hard disk, or RAM disk.

Version Five — \$179. *Professional* — \$295. Demo — \$10.

Available now from your local dealer or direct from:

Stone Edge Technologies, Inc. (215) 641-1825
P.O. Box 200, Maple Glen, PA 19002

Add \$5 for shipping/handling (\$30 outside U.S.A. or Canada)

DB Master is a registered trademark of DB Master Associates. Apple is a registered trademark and AppleWorks is a trademark of Apple Computer, Inc.

A+ TEACHERS' TOOLBOX

Are you considering a network for your class or school? This issue of *A+* is packed with information about the network options from which you can choose. Whether you go with AppleTalk, Corvus, or one of the "other guys," you will have to become familiar with the hardware, the network system software, and the management and installation of curriculum software on the file server.

Today, a lot of networkable software exists to meet most curricular-area needs as well as the productivity needs of teachers and administrators. The system software that comes with the network fileserver is a disk-management program that creates the medium for using software in the network. It lets registered users share programs, data files, hard-disk space, and printers—while they maintain private directories or volumes of their own. Just how the registered users access and use network files is often up to the person handling the network-management software, usually a teacher or network administrator.

When you are making decisions regarding the purchase or installation of a network, take the time to look at *curriculum-management* software. This kind of software is much different than the system-management software. In general, curriculum-management software is built around preexisting educa-

Classroom essential: curriculum-management software

BY JENNIFER BRAWER

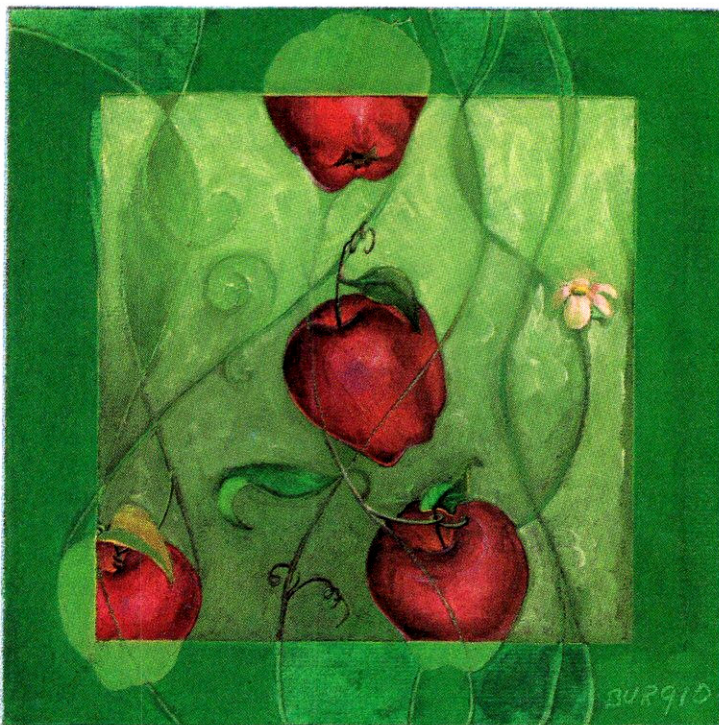

tional software programs and actually manages the delivery of lessons according to a sequence of learning objectives. This type of software also tracks student performance and performs record-keeping functions that are not available on networks running curriculum software solely within the system-management-software parameters.

You can't add just any networkable program to a curriculum-management system yourself. The addition of programs to the system is handled by the developer of the

curriculum-management system. In most cases, you actually mail in your hard-disk drive for upgrades of the courseware. You can, however, install software programs on your network hard disk that do not work with the curriculum manager. You can install them yourself, and they work perfectly but independently of the managed software.

The three types of users in a curriculum-management system are system managers, teachers, and students. Each group of users has a different area of access to the software. System managers and teachers have access to the curriculum-management options, but students do not. The management system organizes courseware into meaningful assignments; coordinates teachers, their classes, and corresponding assignments; enrolls students in classes and tracks their progress; and, finally, organizes and prints detailed reports and summaries.

One-Stop Network Shopping

Those of you already familiar with networks may recognize the company names Computer Network Specialists (CNS) and Ideal Learning, Inc. Their software is fairly prevalent on installed Corvus networks. CNS and Ideal Learning provide a one-stop-shopping approach to LAN (local-area network) purchases for schools, in that they offer network hardware; system and curriculum-manage-

Re-ink Any Fabric Ribbon Automatically For Less Than 5¢ With

MAC INKER™

Over 100,000 sold since 1982

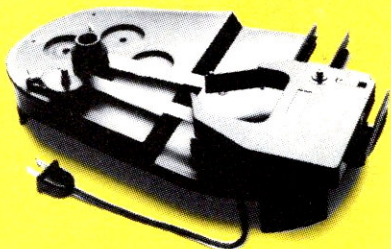

FREE BOTTLE OF INK, RESERVOIR CAP & INK METER

MAC INKER

IMAGEWRIER I AND II	\$42.00
EPSON	\$42.00
UNIVERSAL (INCL. IMAGEWRIER LQ)	\$68.50
MULTICOLOR IMAGEWRIER	\$80.00
MULTICOLOR ADAPTER ONLY	\$40.00

Shipping \$3.00

- Dark, lubricated ink extends print-head life. Re-ink in color too! Bottle \$3.00; pint \$18.50. We have a full range of special inks, heat transfer inks, cartridges and Mac Inkers available.
- Over 16,000 cartridge/spools supported.
- Dedicated Mac Inkers available for extra large or special cartridges.

RIBBONS

Imagewriter Cartridge	\$3.15 ea
4 Color Imagewriter Cartridge	\$10.00 ea

ORDER TOLL-FREE 1-800-547-3303

MODEMS

Mercury 1200AT	\$109.00
Mercury 2400	\$239.00
Capricorn World Minimodem *	\$169.00
Quick Link MAC software (w/ modem)	\$15.00
Commworks Apple software w/ modem	\$60.00
Cable	\$15.00

* Capricorn - 300/1200 baud, supports both US & European standards.

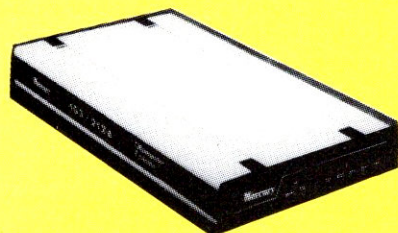

100% Hayes Compatible!
Shipping \$5.00

- 24 month warranty
- Status lights
- Speaker
- Call progress monitoring

DATA SWITCHES

4 pos. 8 pin switch \$50.00



Cable \$15.00
Shipping \$5.00

DB 25, Centronics & 9 pin model available

We have switches and buffers for any application, at the best price in the nation. Ask for brochure.

Cables: We carry cables for Apple computers and peripherals. Rapid turnaround on custom orders.

SPECIAL OFFER: For orders of \$100.00 or more. Tell us where you read this ad and get a free keychain, beeper, and flashlight combined! A \$15.00 value!

30 day money back guarantee on all products. 24 hour shipping.

IN OREGON (503) 626-2291

Computer Friends

14250 N.W. Science Park Drive
Portland, OR 97229,
Telex 4949559, Dealers Welcome.

The cost of a network depends on its size and on the amount of courseware you buy.

ment software; curriculum software; teacher training; and follow-up customer support for hardware, system, and curriculum software.

For those of you who are wondering what is available for Apple Computer's new network, both of these companies are working on AppleTalk products.

ClassWorks

CNS markets a curriculum-management package called ClassWorks (formerly Master Curriculum Manager), a computer-aided-instruction (CAI) software-management tool for Apple II networks. Currently, ClassWorks operates under DOS 3.3, which makes it practical for educational settings, since most Apple II educational software is DOS 3.3-based. ClassWorks manages curriculum packages from more than 20 different educational publishers, including Hartley, Milliken, Random House, DLM Teaching Resources, and Educational Activities. These K-12 software packages contain lessons that target specific math, reading, and language-arts skills. Speech output is available with the reading programs that contain a phonics component, but you'll need extra hardware, a Super-Talker from CNS.

ClassWorks is a flexible program with easy-to-follow documentation. Teachers and system managers can set and change default settings for individual students or for everyone using the system. For example, you can alter the sequence of lessons or adjust students' progress through the lessons according to your own mastery or review criteria. You can even set the system to a Pretest/Posttest mode that lets you perform diagnostics and evaluation.

Two important ClassWorks features are the student-information and student-assignment matrices, which are for tracking and customizing student assignments. As soon as students enroll in a class, they get their own student matrix with default assignment settings that

WordPerfect taps the power of mice and menus.

The most powerful word processor you can buy for your Apple® IIgs™ is wearing a brand new face these days. One that gives you the simplicity of a mouse and menu-driven interface, the speed of keyboard commands, and the power of literally hundreds of features.

Tapping Your IIgs.

Using WordPerfect for the Apple IIgs is as easy as looking at a menu, clicking on the feature you want, and typing away. Yet, WordPerfect offers another option that gives power typists the ability to invoke sophisticated features without ever leaving the keyboard.

With WordPerfect, you can produce flawless footnotes and endnotes. Or check your spelling with a 115,000-word dictionary. Or find the right word using the thesaurus. With the flick of a finger you can open an unlimited number of windows, each containing different documents. You can interchange text between documents. And you can

CIRCLE 120 ON READER SERVICE CARD

perform scores of other functions like mail merge, macros, on-screen formatting, super/subscript, automatic page numbering, and more.

WordPerfect Flexibility.

In addition to running on the IIgs, WordPerfect is available for the IIe/IIc (with a 50,000-word dictionary). And files from both versions can be interchanged with WordPerfect files generated on other machines, including IBM® PC compatibles and some minicomputers.

No other word processor lets you flex the word processing muscle of your IIgs like WordPerfect. For more information, including special programs for educators, call or write WordPerfect Corp., 288 West Center St., Orem, Utah 84057 (801) 225-5000.

WordPerfect
CORPORATION

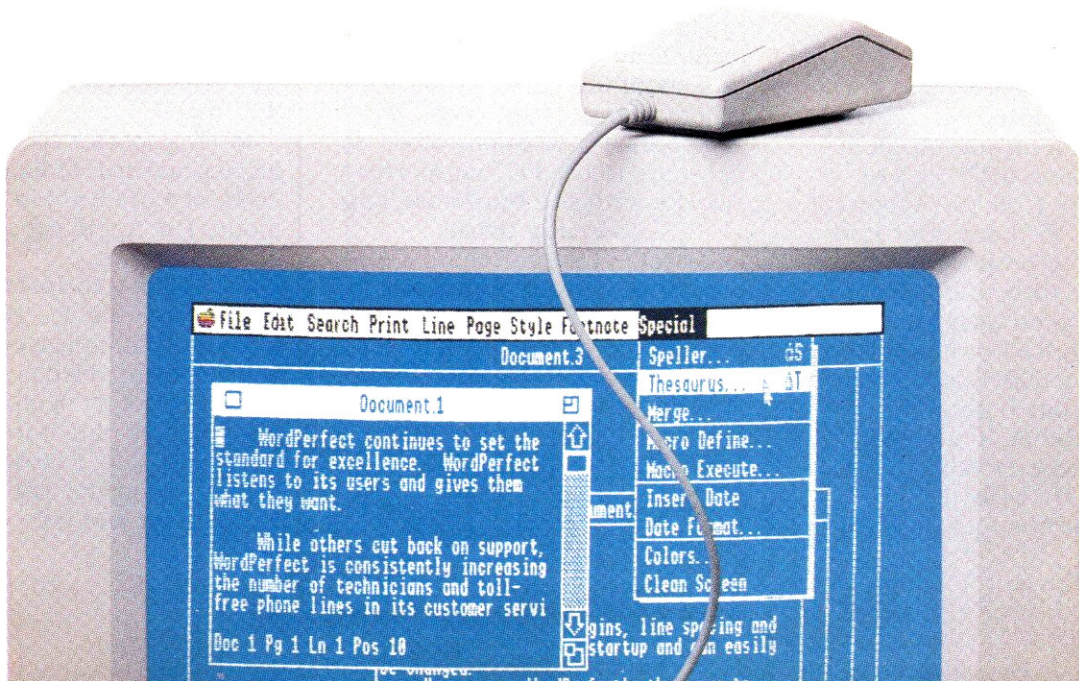



Now Apple speaks IBM. Three times faster than IBM.

Introducing PC Transporter.[™] The Apple[®] II expansion board that lets you run MS[®]-DOS programs.

Now your Apple II can run over 10,000 programs you could never use before. Like Lotus[®] 1-2-3[®], MultiMate[®], dBASE III PLUS[®], Even Flight Simulator[®].

With PC Transporter, MS-DOS programs run on your Apple II like they do on IBM[®] PC's or compatibles. With one important difference. PC Transporter runs most of those programs *three times faster* than an IBM PC/XT[®].

Plus, to speed through number-crunching tasks, you can use our optional 8087-2 math coprocessor chip. It plugs into a socket on the PC Transporter.

Less expensive than an IBM clone.

Sure, a stripped-down IBM

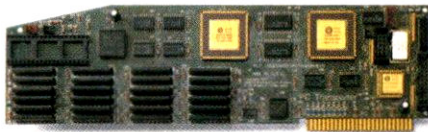

clone costs about the same as the PC Transporter. But the peripherals it takes to get the clone up and running make the clone cost about three times what our American-made card costs.

You don't have to buy new hardware to use PC Transporter.

Works with the hardware you already own.

With PC Transporter, MS-DOS programs see your Apple hardware as IBM hardware. You can use the same hardware you have now.

With IBM software, your Apple hardware works just like IBM hardware. Including your drives, monitors, printers, printer cards, clock cards and serial clocks.

You can use your Ile[®] or IIGs[™] keyboard with IBM software. Or use our optional IBM-style keyboard (required for the II Plus).

You can use your Apple mouse. Or an IBM compatible serial mouse.

Plenty of power.

PC Transporter gives you as much as 640K of user RAM and 128K of system RAM in the IBM mode.

PC Transporter also is an Apple expansion card, adding up to 768K of extra RAM in the Apple mode. The Apple expansion alone is a \$300 value.

Easy to install.

You can install PC Transporter in about 15 minutes, even if you've never added an expansion board. You don't need special tools. Simply plug it into an Apple expansion slot (1 through 7 except 3), connect a few cables and a disk drive, and go!

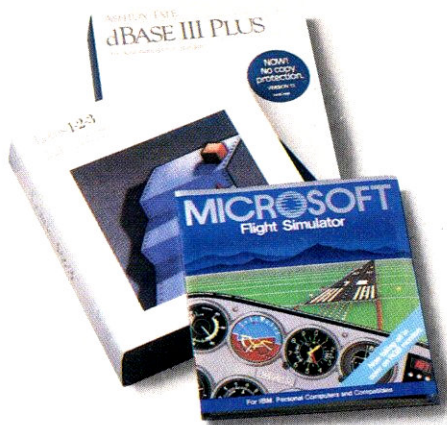

PC Transporter taps into the world's largest software library. Now your Apple can run most of the IBM software you use at work. And it opens a new world of communications programs, games and bulletin boards.

A universal disk drive controller.

PC Transporter supports 3.5" and 5.25" MS-DOS and ProDOS formatted diskettes. You'll shift instantly between Apple ProDOS and IBM MS-DOS.

You'll need our versatile 5.25" 360K drive system to run IBM applications from 5.25" floppy disks. Use your Apple 5.25" drive for Apple 5.25" disks.

An Apple Disk 3.5 Drive will support the new 3.5" disks whether they're IBM MS-DOS formatted or Apple ProDOS formatted. The PC Transporter acts like an Apple Disk 3.5 Drive disk controller for IIGs, IIE, and II Plus users.

PC Transporter supports up to 5 drives in a number of combinations.

For example, you can connect a 5.25 Applied Engineering 360K dual-drive system directly to the card. Then plug two daisy-chained Apple 3.5 Drives (not the Apple UniDisk 3.5) to the dual-drive system. For a fifth drive, use a ProDOS file as an IBM hard disk.

PC Transporter controls Apple and IBM compatible disk drives. It supports 3.5" and 5.25" MS-DOS and ProDOS formatted diskettes.



Versatile data storage.
PC Transporter reads MS-DOS and translates it into Apple native ProDOS. You can store IBM programs and data on any ProDOS storage device including the Apple 3.5 Drive, Apple UniDisk™ 3.5, Apple 5.25" drive, SCSI or ProDOS compatible hard drives. (You can use the Apple UniDisk 3.5 with its own controller card for storing programs and data, but not for directly booting an IBM formatted disk.)

You can even use our 360K PC compatible drive for ProDOS

Make your Apple speak IBM.

PC Transporter memory choices.

RAM in Apple mode:	RAM in IBM mode:	Price:
384K	256K	\$489.00
512K	384K	529.00
640K	512K	569.00
768K	640K	609.00

Note: The IBM mode is 128K less because the PC Transporter uses 128K for system memory.

IIGs Installation Kit 49.00

IIE/II Plus Installation Kit 39.00

PC Transporter Accessories

5.25" IBM Format 360K Drive Systems

Single-Drive System 269.00

Dual-Drive System 399.00

Half-Height Drive 135.00
(add to Single-Drive system to make Dual-Drive)

IBM-Style Keyboard 139.00
(required for Apple II Plus. Requires IBM Keyboard Cable.)

IBM Keyboard Cable 34.00

Sony RGB Monitor 499.00

Analog RGB Cable 39.00
(for use with Sony monitor)

Digital RGB Cable 39.00
(for use with Sony monitor)

Digital RGB Adapter 24.00

ColorSwitch 44.00
(included with IIGs Installation Kit)

128K ZIP 40.00

PC Transporter Memory Expansion Chip Set per set

8087-2 Math Co-processor Chip 229.00

Heavy Duty Power Supply 69.00
(IIE and II Plus only)

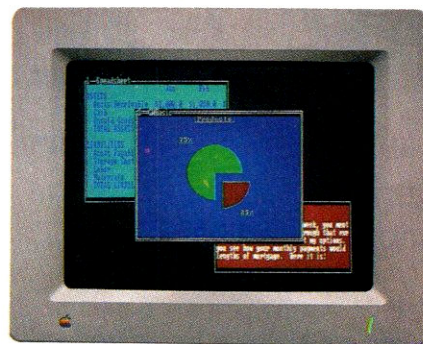

PC Transporter produces better IBM graphics than IBM. Analog is sharper than digital. So with an analog RGB monitor, PC Transporter's CGA graphics and text are superior to IBM's digital display — even while running IBM software!

And, you can also use an Apple composite monitor in IBM text or graphics mode.

storage and a 143K Apple 5.25" drive for MS-DOS storage.

Created by Apple's original designers.

The brains behind PC Transporter were also behind your Apple II.

The PC Transporter design team includes the former project managers for the creation of the Apple IIE and IIC. The co-designer of the Apple II disk controller. And the first full-time Apple programmer and author of the ProDOS operating system.

So you know the PC Transporter and your Apple were made for each other.

Support and service from the leader in Apple add-ons.

Applied Engineering sells more Apple peripheral boards than anyone else — including Apple Computer. So you know we'll be around after the sale.

PC Transporter comes with a 15-day money back guarantee. If you're not fully satisfied after using it, return it for a full refund. PC Transporter also comes with a 1-year warranty.

How to get your PC Transporter today.

See your dealer. Or call Applied Engineering any day between 9 a.m. and 11 p.m. CST at 214-241-6060.

AE Applied Engineering
The Apple enhancement experts.

P.O. Box 798, Carrollton, TX 75006
214-241-6060

A Division of AE Research Corporation.

FREEZE

Capture any screen in any application and make the most of your Apple IIGS®.

Press the Fingerprint button, instantly freeze the screen and enter the GSi desktop without exiting from the application. Instantly dump screens to the printer, to disk, or re-load captured screens into other applications. Press the escape key and return to the application where you left off.

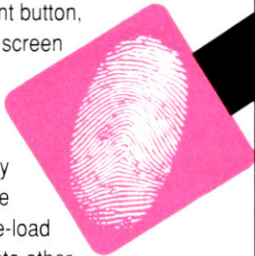

In the GSi desktop, screens can be cropped, rotated, stretched, inverted, repositioned, and enlarged up to eight times original size. You can position output, set line width, automatically print page numbers, page headers, specify multiple copies, change fonts, styles, and sizes as well as image colors, and control other special printer effects. All features are available in pull-down menus.

Desk accessories in the GSi desktop include a typewriter (to type labels and add text to captured screens); a calendar with past, present and future dates; and a calculator.

The Fingerprint® GSi multifunction card plugs directly into slot 3 (or any other open slot) and is ready to use immediately. The GSi manages the two GS serial ports and an auxiliary Fingerprint serial or parallel card. The GSi will not interfere with the operation of any software or operating systems. Fingerprint models are available for the Apple IIe, IIc, and II+.

At \$99.00, the Fingerprint GSi gives your IIGS the magic touch affordably. To order your GSi, call 305/592-7522 today.

Reliable Printer Switching Devices From Thirdware

Basic Two Computer AB Switch Box	39.00
Basic Four Computer ABCD Switch Box	59.00
Intelligent Four Computer "Smart Switch"	199.00
Intelligent Eight Computer "Smart Switch"	259.00

FIVE YEAR WARRANTY ON ALL PRODUCTS



THIRDWARE
COMPUTER PRODUCTS

4747 NW 72nd Ave., Miami, Florida 33166
Telephone 305/592-7522

Apple is a registered trademark of Apple Computer, Inc.
Fingerprint is a registered trademark of Precision Software, Inc.

the teacher can modify. As students progress through a lesson sequence, the system tracks their performance and progress results on their matrix. The matrices also contain information for the reports ClassWorks can generate: Assignment Results, Class Roster, Class Status, Class Summaries, Mastered Objectives, and Objective Range (the range of mastered assignment objectives).

Integrated Classroom Learning System

The Integrated Classroom Learning System from Ideal Learning, Inc., has management capabilities similar to those of ClassWorks. It organizes CAI software into lesson plans based on individual teacher objectives; offers curricular sequences for language, reading,

One teacher and a single network can serve many students, who share peripherals such as disk drives.

math (including calculus), science, and foreign language (currently Spanish and German); and generates a variety of reports.

In addition to CAI programs in the listed curricular areas, Ideal Learning offers a special product called Writer's Network. Writer's Network is a complete, interactive, multiyear writing curriculum designed to teach writing according to the latest research. An "error profile" that automatically accompanies each student essay decreases the work load of teachers who use Writer's Network. The profile includes information on the ratio of "to be" verbs, a "vague word" index, sentence lengths, and word frequencies. The program also logs teacher comments and grades.

Ideal Learning differs from CNS in that the former develops its own educational software. The Integrated Classroom Learning System manages Ideal Learning's own software as well as other products from third-party developers. Ideal Learning also provides a unique service option with its software. If you buy its curriculum-management software and courseware, the

company will provide a custom correlation of objectives to your school or district curriculum. Two other valuable features of Ideal Learning's CAI courseware are a diagnostic test-scoring and reporting system and an authoring system that allows teachers to add supplementary lessons.

Worth the Cost

A network requires a major expenditure, whose total depends on the size of your network and the amount of courseware you buy. Where you save money is in the increased efficiency of instructional delivery and reduced costs for peripherals. One teacher and a single network can serve many students, who share peripherals such as disk drives and printers. The sophistication of the report functions and the absence of disk management also free teachers from many purely administrative responsibilities. +

VITAL STATISTICS

ClassWorks

Computer Networking Specialists, Inc. (CNS)
Rt. 1, Box 286-C
Walla Walla, WA 99362
(800) 372-3277
In WA (509) 529-3070

List Price: contact company for prices of custom installations

Requires: Apple IIe or IIGS with 128K RAM as "master computer"; Apple II Plus, IIe, or IIGS computers with 48K RAM as student "workstations"; printer; network system.

CIRCLE READER SERVICE NO. 358

Integrated Classroom Learning System

Ideal Learning, Inc.
5005 Royal Lane, Suite 130
Irving, TX 75038
(214) 929-4201
or
327 South Marschall Road
Suite 200
Shakopee, MN 55379
(612) 445-2690

List Price: contact company for prices of custom installations

Requires: Apple II Plus, IIe, or IIGS with 128K RAM and one disk drive as "teacher station"; Apple II Plus, IIe, or IIGS with 64K RAM as "student station"; network system.

CIRCLE READER SERVICE NO. 359

CIRCLE 160 ON READER SERVICE CARD



Get the lion's share online with GENie.

"GENie changed my mind about what an online service can do for me! I always knew that GENie offered a princely selection of Special Interest Groups featuring thousands of software files, dynamic bulletin boards, lively discussions and "tips" from the experts. But now GENie gives me more than my share of valuable information services like NewsGrid and USA Today Decision-lines, American Airlines EAASY SABRESM personal reservation system, new and exciting multi-player games and access to Dow Jones News/Retrieval.[®] And the people on GENie are so friendly and helpful they make me feel like a member of royalty!

You don't need to pay a king's ransom to get the lion's share, because only GENie offers you so much online, for less."

Services Available	Compare & Save	Pricing*			
		Registration Fee	Monthly Minimum	Non-prime Time Rates	
				300 baud	1200 baud
Electronic Mail • CB • SIGs/User Groups • Travel • Shopping • Finance • Reference Professional • Leisure • Games • News	GENie†	\$29.95*	None	\$5.00	\$5.00
	CompuServe	\$39.95	None	\$6.00	\$12.50
	Other	\$49.95	\$10.00	\$8.40	\$10.80

*\$18 Registration fee extended to 12/31/87.

Just \$5 per hour. Get online today!

1. Have your major credit card or checking account number ready.
2. Set your modem for local echo (half duplex)—300 or 1200 baud.
3. Dial 1-800-638-8369. When connected, enter HHH
4. At the U# = prompt enter **XJM11823, GENie** then RETURN.

Need help or more information?
No modem yet? We can help.
In U.S. or Canada call
1-800-638-9636.

GENie™
We Bring Good Things Online.



GE Information Services

© 1987 General Electric Company, U.S.A.

*Basic rates and services in effect 9/87 apply in U.S. only. †Non-prime time rates apply Mon.-Fri. 6 PM-8 AM local time and all day Sat., Sun., and nat'l. holidays. Subject to service availability. Some services offered on GENie may include additional charges.

Dow Jones News/Retrieval is a registered service mark of Dow Jones & Company, Inc.

Move Up to the Gold Standard in IIGs Paint Programs

Power Features	Paintworks Gold™	DeluxePaint® II
Freehand 3-D	✓	
Automatic 3-D	✓	✓
3rd screen to copy any image from a file	✓	
Automatic 256 color gradient palette	✓	
Rotate objects in 1° increments	✓	✓
2 canvases to paint on	✓	✓
Mask any area or image at any time	✓	
Mask colors	✓	✓
Slippy colors for lasso	✓	
Variable-zoom FatBits	✓	✓
16 Built-in patterns in the on-screen toolbox	✓	
4 Independent 16 color gradient palettes	✓	
Resize & bend objects	✓	✓
Distort objects	✓	
Anything can be a brush	✓	✓
Variable speed animation	✓	
Color cycling (simulated animation)	✓	✓
Smear, shade, & smooth colors	✓	✓
Automatic corner rounding	✓	
Autotightening lassos	✓	
On-line Help	✓	
Total	21	9

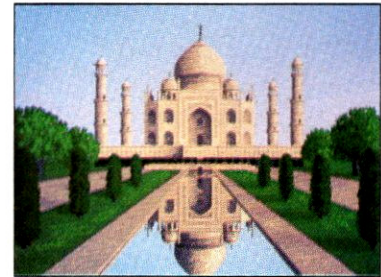
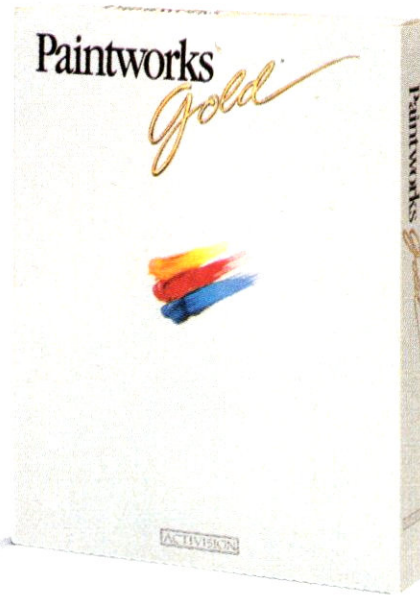

Two styles of 3-D put your pictures in perspective. To create the reflection, just rotate the Taj Mahal, mask all but the water, and use the palace itself as your brush. Fill the skies with gradient color for a setting fit for a king.

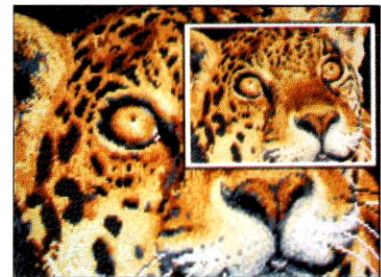

The variable-zoom FatBits editor lets you magnify up to 4X, then use any tool in either window. Here you can see the smoothing effects used to create the subtleties in the leopard's face.

Introducing Paintworks Gold—the new standard in paint programs for the Apple IIGs.

Over 80 new features, including 35 you can't get anywhere else. And all the ease of use that made Paintworks Plus the best-selling IIGs paint program.

Paintworks Gold is compatible with all IIGs graphics formats. But no other IIGs paint program can touch it — for elegance, simplicity, and sheer creative power.

Upgrade Now — Save up to \$80

Upgrade from any competitive IIGs paint program for just \$40 (Paintworks Plus owners, only \$20 if you respond by May 31, 1988).

Send page 1 from your manual (originals only) and a check or money order to: **The Gold Standard, P.O. Box T, Gilroy, CA 95021-2249.**

Please add \$3.50 for shipping and handling. (For orders shipped to CA, add 6.5% sales tax.)

Paintworks Gold requires an Apple IIGs with minimum 1.25 Mb RAM.

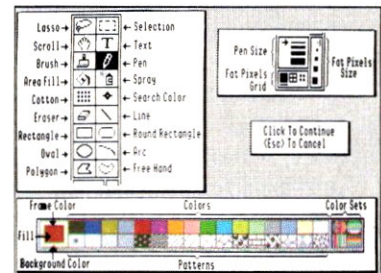

Over 80 new features, including on-screen gradient fill tools and variable FatBits controls. And if you forget the commands, three help screens like this one are just a click away.

ACTIVISION

*Five alternatives
for enterprising
networkers*

APPLETALK CABLING SCHEMES

The AppleTalk Network System works with a variety of cabling schemes. The most common one uses the LocalTalk cable and connectors Apple sells (see figure 1). In this article, I look at what's inside a LocalTalk connector and suggest alternative, money-saving cabling schemes you might want to use in your Apple II AppleTalk network. I'll also share my ideas on whether you should bypass AppleTalk altogether if all you need to do is communicate with a LaserWriter.

One of the ruder surprises that greets AppleTalk network users is that the LocalTalk cables for hooking up your Apple II to a LaserWriter may cost as much as \$150. Yet this \$150 may be an unneeded expense for many people most of the time. In fact, you can connect a LaserWriter to AppleTalk by using nothing but three pieces of doorbell wire—at near-zero cost!

Two Myths Shattered

Here's a look at what's in Apple's magic cables and connectors, followed by five conventional and not-so-conventional alternatives to the stock LocalTalk cables and connectors. (A LocalTalk connector is a connection box with a short built-in cable that plugs into the computer.) But first I want to shatter two networking myths.

Myth #1 says that you must use the AppleTalk network to use a LaserWriter. This myth is totally, absolutely, and positively untrue. You can easily and rapidly communicate with a LaserWriter from any old serial port on any old personal



Figure 1: A LocalTalk connector, showing the connection box and drop cable. The drop cable connects to the IIe or IIgs.

computer at speeds up to 57,500 baud.

Myth #2 says that AppleTalk is faster than plain old 9600-baud serial communications. This myth falls by the wayside, though, assuming that you are using the current AppleTalk firmware with typical applications.

In theory, the AppleTalk baud rate is way up there at 230 kilobaud if you're using LocalTalk cable. Thus, you would somehow expect at least a 24:1 speed advantage over a 9600-baud serial connection. In

the real world, however, the AppleTalk firmware's handshaking and software overhead can sometimes gobble up this 24:1 speed advantage and then some. Thus, what really matters is the overall "click to clunk" time, not just the baud rate.

To prove this point, I took Meowrrrr, a feline I'd designed with the LaserWriter's PostScript page-description language, and printed him through LocalTalk and then through some serial ports. The results were surprising, to say the least (see figure 2).

On a LaserWriter Plus with version 47 of PostScript, the repeat copies of Meowrrrr took 90

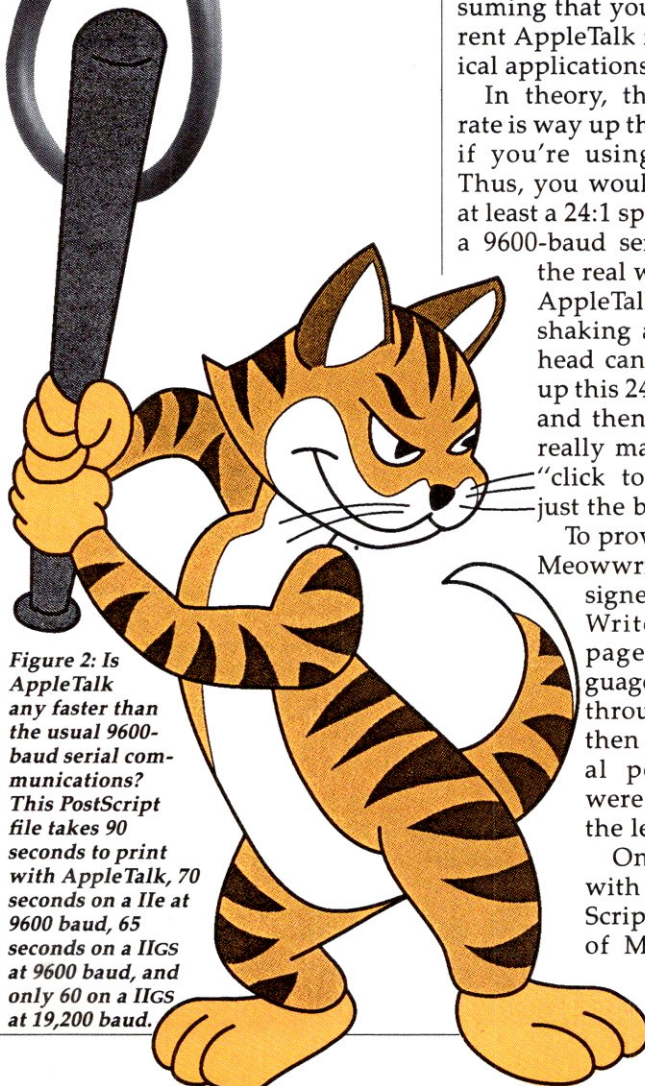

Figure 2: Is AppleTalk any faster than the usual 9600-baud serial communications? This PostScript file takes 90 seconds to print with AppleTalk, 70 seconds on a IIe at 9600 baud, 65 seconds on a IIgs at 9600 baud, and only 60 on a IIgs at 19,200 baud.

NETWORK

seconds to print under AppleTalk with LocalTalk cable. Compare this result with the times I got when I used a standard serial-interface cable: 70 seconds on a IIe at 9600 baud, 65 seconds on a IIGS at 9600 baud, and 60 seconds on a IIGS running at 19,200 baud.

If you go to very large files, particularly ones that involve PostScript halftones or bit maps, then AppleTalk starts to show a modest

speed advantage over 9600 baud.

Since today's AppleTalk often has no speed advantage whatsoever over standard serial communications, I certainly expect Apple to clean up its act sometime in the future and give us some faster networking code.

Today, though, far and away the fastest method for driving a Laser-

Writer is to use a IIGS at 57,500 baud, going out the game-paddle port by way of "bare metal" hand-crafted machine-language code. I leave creating such a setup as an exercise for Apple II hardware hackers everywhere!

I don't mean to say you should never use AppleTalk. AppleTalk is well suited for networking over longer distances, where several different hosts and peripherals must share each other. You also need it to use an AppleShare file server. The usefulness of a LaserWriter diminishes dramatically if you cannot reach out and touch it from your workstation, though, and standard A-B serial switch boxes and serial communications can often be an inexpensive alternative to true networking.

So, your first and by far cheapest alternative to LocalTalk cables is simply to avoid using the AppleTalk network in the first place.

Inside That Lump

Perhaps you really do need long-distance communication, with several hosts using a common printer and sharing a file server. In such a situation, AppleTalk is for you. Your goal now should be to minimize your cabling costs.

By now, you've probably seen that ominous-looking lump in the stock LocalTalk connectors. What is in that lump? What makes it so special?

Figure 3 bares all. Inside the lump is a 50-cent transformer, a couple of resistors and capacitors, and some connectors and switches. And that's it.

The transformer is there for safety and noise isolation. It also creates a "balanced" high-frequency signaling system that is immune to external noise. In order to avoid any cable reflections, the transformer switches in a 100-ohm resistor if only a single output cable is in use.

Your second method of reducing AppleTalk cable costs is to build up clones of the figure-3 circuit on your own. Chances are you can use a Hong Kong audio-interstage transformer instead of that fancy toroidal job in the figure. If you do get into any serious home-brew cabling, be sure to check out the good folks at Redmond Cable. They

YOUR LOWEST PRICE SOURCE FOR APPLE COMPATIBLE COMPUTERS

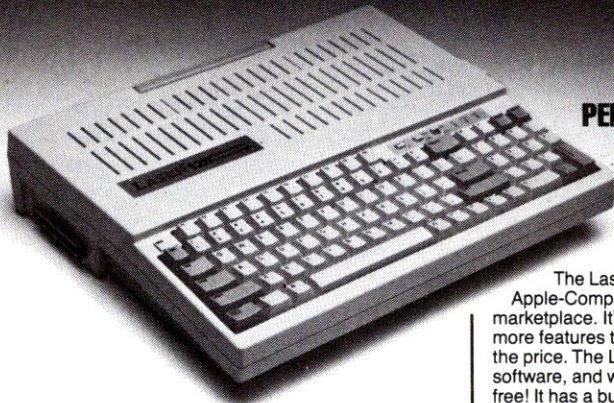

LASER 128
PERSONAL COMPUTER
APPLE IIe/IIc
COMPATIBLE
\$395
(Includes 10 free software programs)

The Laser 128 is the most affordable Apple-Compatible computer on the marketplace. It's a great little machine with more features than an Apple for about half the price. The Laser 128 runs Apple IIe/IIc software, and we give you ten programs - free! It has a built-in disk drive and features parallel, serial, modem and mouse interfaces. It even has an expansion slot to add more capabilities to your computer. The Laser 128 is a very popular machine because it's Apple compatible and it's a great deal at the low price of: **\$395**

LASER 128 SYSTEMS

THE HERO: Laser 128 w/Monochrome Monitor **\$479**

THE STAR: Laser 128 w/Monochrome Monitor and Star NP-10 Printer and Cable **\$649**

THE SUPERSTAR: Laser 128 w/RGB Color Monitor and Star NP-10 Printer and Cable **\$839**

New Laser 128EX Now Available

The Laser 128EX is a high performance Apple-compatible computer with all the features of the Laser 128, plus a triple speed processor and is internally expandable to over 1Mb. The Laser 128EX is 3 times faster than an Apple IIe or IIc and at only **\$499**

LASER 128 ACCESSORIES & PERIPHERALS

Laser External Disk Drive (SSDD)	\$129	Laser RF Modulator	\$ 25
12" Monochrome Monitor	\$ 89	Laser Technical Reference Manual	\$ 19
RGB Color Monitor	\$265	Parallel Printer Cable	\$ 19
Star NP-10 Printer	\$179	Serial Printer Cable	\$ 19
Laser Mouse	\$ 59	RGB Color Monitor Cable	\$ 19
Laser Expansion Box	\$ 49	Apple II-Compatible Disk Drive	\$129
Laser Joystick	\$ 20	Macintosh-compatible Disk Drive	\$179

USAMICRO YOUR DIRECT SOURCE FOR APPLE AND IBM COMPATIBLE COMPUTERS

2888 Bluff Street - Suite 257 • Boulder, CO 80301

Your satisfaction is our guarantee!



8 - 5 Mountain Time
No Surcharge for Credit Cards
Colorado Residents Add Sales Tax
Add 3% Shipping & Handling Charge

TOLL FREE:

(800) 654-5426

(303) 494-3548

CIRCLE 294 ON READER SERVICE CARD

F R E E D O M

of the press

PERSONAL NEWSLETTER GIVES YOU THE *FREEDOM* TO CREATE EXCITING, EYE-CATCHING DESIGNS. ENTER THE WORLD OF DESKTOP PUBLISHING USING A IIe, IIc OR IIgs AND CREATE NEWSLETTERS, POSTERS, FLYERS, BUSINESS FORMS AND MUCH MORE. *Getting your message across with Personal Newsletter is a Breeze.* THE TEXT EDITOR GIVES YOU A VARIETY OF FONTS AND STYLES, USE ANY OF THE SOPHISTICATED FEATURES FOUND IN PROFESSIONAL DESKTOP PUBLISHING PROGRAMS LIKE LEADING, KERNING AND AUTOMATIC REFORMATTING, OR IMPORT TEXT FROM YOUR FAVORITE WORD PROCESSOR. *No more struggling with graphics programs—* PERSONAL NEWSLETTER HAS A FULL FEATURED MAC-LIKE GRAPHIC EDITOR, BUILT IN! OR YOU CAN IMPORT PICTURES FROM PRINT SHOP,TM NEWSROOMTM AND DAZZLEDRAW.TM PERSONAL NEWSLETTER EVEN USES SCANNED PICTURES FROM THUNDERSCANTM AND COMPUTER EYES.TM *No more boring two-column layouts!* PERSONAL NEWSLETTER LETS YOU CREATE UP TO NINE COLUMNS. SO YOU HAVE THE *FREEDOM* TO CREATE PAGES ANYWAY YOU WANT, MIXING GRAPHICS AND TEXT TOGETHER QUICKLY AND EASILY. *Best of all you get freedom from over priced software.* PERSONAL NEWSLETTER ONLY COSTS \$59.95 (SUGGESTED RETAIL PRICE) AND COMES WITH OVER 200 PIECES OF CLIP ART. CIRCLE 293 ON READER SERVICE CARD

Personal Newsletter is a trademark of Softsync, Inc. All other trademarks acknowledged.

SOFTSYNC, INC.[®]

162 Madison Ave. New York, NY 10016 (212) 685-2080



Personal Newsletter[™]

Desktop Publishing Made Fast and Easy

- Create Newsletters, Proposals, Reports, Invitations, Awards, Ads, Flyers, Forms, Cards, Presentations, Announcements and more.
- Includes sample newsletters, page layouts, many type styles (fonts), and clip art.



NETWORK

stock the mini circular 8 and DB9 plugs you'll need, besides also offering a wide variety of stock and custom interface solutions.

Alternatively, you can save a little money by buying compatible cables and connectors from third-party sources such as AESP, Inc., or Monster Cable Products, Inc.

Using Twisted Pair

In the long run, the only economically acceptable cable I recommend for local-area networks is the extra twisted-pair lines the telephone company installed when it hooked up your telephone.

Fortunately, AppleTalk works quite nicely over unused telephone lines, making all of those expensive LocalTalk cables unnecessary in many situations. So, the third approach to AppleTalk cabling involves substituting your extra phone lines or using ordinary twisted-pair wire. This scheme is the one the *A+* editorial staff uses, by the way.

An interesting series of products from the Farallon Computing peo-

ple lets you substitute ordinary telephone lines for the fancy LocalTalk cables. Besides lower-cost con-

nectors that terminate in ordinary telephone plugs, they also have repeaters that allow you to go well beyond the 3000-foot limit of LocalTalk cables.

Figure 3: Schematic for the stock LocalTalk drop cable. The balanced transformer provides both isolation and noise immunity.

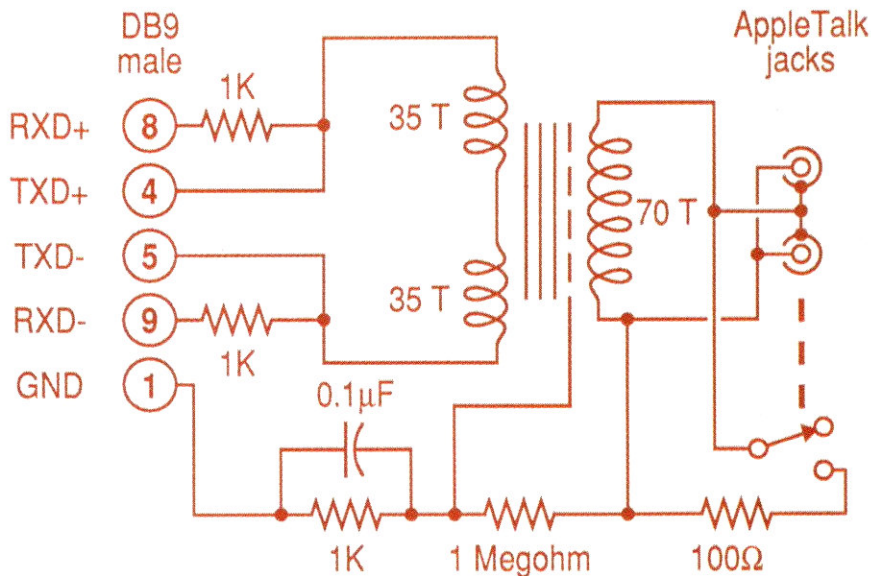

Ribbon Land

THE BEST FOR LESS

ORDER HOTLINE 1-800-221-4892
IN PA OR CUSTOMER SERVICE 215-524-9760

Printer Type	Black		Color	
	Ea.	6+	Ea.	6+
Apple Imagewriter.....	4.00	3.50	4.50	4.00
Apple Imagewriter II (Multi-color).....	4.00	3.50	10.00	9.00
Apple Scribe Thermal (Black only).....	6.50	6.00	-----	-----
Epson LX 80/86/90.....	4.00	3.50	4.50	4.00
Epson MX, FX, RX 80/85.....	4.00	3.50	4.50	4.00
Epson MX, FX, RX, 100/185**.....	5.00	4.50	5.50	5.00
Okidata 82/83/92/93, Star SG10.....	2.00	1.75	2.50	2.25
Okidata 120/182/192/193**.....	5.50	5.00	6.00	5.50
Panasonic 1080/1090/1091/1092**.....	5.50	5.00	6.00	5.50
Seikosha SP 1000, Epson AP 80**.....	5.50	5.00	6.00	5.50
Toshiba 1350/1351/RS, DMP 2100**.....	4.50	4.00	5.00	4.50

Single colors available for all ribbons listed above unless otherwise indicated.
Colors: Red, Blue, Green, Yellow, Brown, Purple, Orange and Silver.
**Orange & Silver NOT available for these printer types.

	Per Disk	1-9 PKGS	10+ PKGS
C. Itoh 3.5" DS 10/bx.....	1.99	19.90	18.80
C. Itoh 3.5" DS 10/pk*.....	1.59	15.90	14.90
C. Itoh 3.5" DS Color**.....	2.39	23.90	22.90
Sony 3.5" DS 50/bx.....	1.49	74.50	69.70
DataSafe 5.25" DS/DD (Bulk*) 20/pk.....	.44	8.80	8.40
Verbatim DataLife 5.25" DS/DD 10/bx.....	1.19	11.90	11.40
Verbatim 5.25" (Bulk*) 20/pk.....	.49	9.80	9.40
3M 5.25" DS/DD 10/bx.....	1.29	12.90	12.40
3M 5.25" DS/DD (Bulk*) 20/pk.....	.59	11.80	11.40
Maxell 5.25" DS/DD 10/pk.....	1.39	13.90	13.40
Maxell 5.25" DS/DD (Bulk*) 20/pk.....	.69	13.80	13.40
Sentinel 5.25" Color DS/DD (Bulk*)***.....	.69	6.90	6.40

* C. Itoh disks in 10/pk are bulk but come in a free plastic disk box.
(Bulk*) Disks come with labels & sleeves in plastic wrap without boxes.
** C. Itoh Color Disks include 2 each of: Red, Lt. Blue, Green, Yellow & Orange, plus a free plastic disk box.
*** Sentinel Color Disks include 1 each of: Red, Lt. Blue, Dk. Blue, Maroon, Green, Yellow, Orange, Grey, White & Black.

Multi-Strike	Film	Ribbons
Apple Imagewriter Film.....	4.50	NEC 3500 (1 pass)..... 5.00
Brother HR 15.....	4.75	Okimate 10/20..... 5.00
Commodore 1526/802*.....	5.50	Qume IV..... 5.00
Diablo Hi-Type 2*.....	4.00	Silver Reed EXP 400/500..... 4.00
NEC 3500 (Flip Cartridge).....	8.00	Spirit 80, Legend 808/880*..... 5.50

* Some colors available CALL

** 6+ Discount 50¢ per ribbon

Paper	Products
Bright or Pastel Rainbow Pack Paper	
100 each of 6 colors (Specify Bright or Pastel)...	24.00
Matching Announcement Envelopes (300).....	19.50
Parchment Paper (Tan, Ivory, Grey or Gold)	
100 sheets of one color.....	6.00
Matching Envelopes (in 3 sizes).....	CALL
Banner Paper 45" roll (one roll of one color)	
Pnk, Blu, Grn, Wht, Yell, Gld.....	8.00
White 9 1/2"x11" Micro-perf (2500 shts).....	26.00
Pin Feed Rol-O-Dex StyleCards(500).....	7.00
Continuous Index Cards (100 of one color)	
Pnk, Blu, Grn, Yell, Org.....	2.00
Continuous Post Cards (250 of one color)	
Pnk, Blu, Grn, Wht, Yell, Org.....	8.00

MacInkers	
Dedicated Imagewriter, C. Itoh Prowriter.....	41.95
Dedicated Imagewriter II (Multi-color).....	74.95
Dedicated Epson MX, FX, RX 80/85/100/185.....	49.95
Universal Base (includes 1 driver of your choice).....	64.95
Additional Driver Kits (for use with Universal model).....	10.50
Ink Kit (Required)*.....	8.00

*Colors Available: Black, Red, Blue, Green, Yellow, Brown, Purple, Orange
IW 4-color & Silver (Silver Ink Kit \$13.00).

Surge Suppressor (6 outlet strip).....	14.95
Plastic Disk Box (holds 40 3.5" disks).....	10.00
Plastic Disk Box (holds 100 5.25" disks).....	11.00
Disk Notcher.....	5.00

Policies
• Visa, MC & AmEx accepted.
• School & Business purchase orders accepted in hard copy or FAX only.
• Company C.O.D. orders only.
• In PA add 6% sales tax.
• Minimum order \$20.00.
• Shipping Charges Ribbons & Disks-
• UPS Ground/Continental USA \$4.00
• US Mail/Canada/APO/FPO \$6.00
• Paper orders, Foreign orders,
• UPS Blue, UPS Red CALL

"Many More Products Available"

RIBBONLAND
P.O. BOX 506 • EXTON • PA • 19341

RamFactor™

The Ultimate Slot 1-7 Memory Card

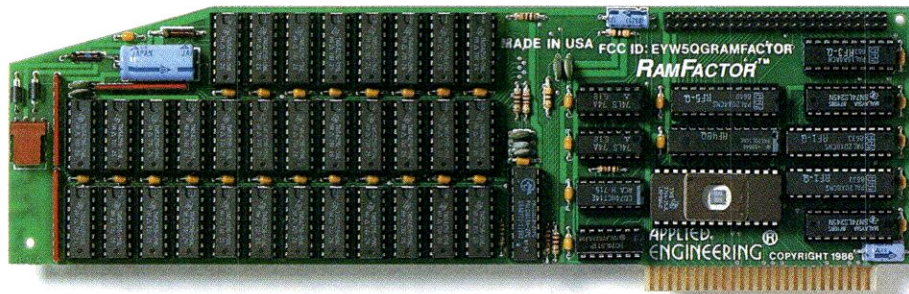

RamFactor is automatically recognized as additional workspace memory by AppleWorks 1.3 and 2.0. In addition, RamFactor's memory can be used for creating the ultimate in program speed—a lightning-fast RAMdisk for the Apple IIGs, IIe, II+, Franklin and Laser 128. A RAMdisk does not depend on the slow moving parts of a conventional floppy drive. RAMdisks eliminate wear and tear on your disk drive plus your programs run up to 20 times faster! When a program is in RAM, your computer won't have to search for it in the mechanical disk drive during program operation. With RamFactor, you can have up to 9 separate simultaneous RAMdisks—even in different operating systems! Now you can instantly switch from one program to another or even switch from AppleWorks to DOS 3.3 to CP/AM to Apple Pascal 1.3 to ProDOS.

Apple Memory Expansion Card Compatible

RamFactor is 100% Apple Memory Expansion Card compatible. This means that software designed for Apple's card is automatically compatible with RamFactor. Thousands of software programs—including AppleWorks, Pinpoint, MacroWorks, MultiScribe, and Managing Your Money—can take advantage of the speed and performance RamFactor provides. But with Apple's card, you can have only one RAMdrive partition instead of the 9 simultaneous RAMdrives that RamFactor offers. And that's only part of the story . . .

2.0 AppleWorks Power

Other slot 1-7 cards can give AppleWorks a larger desktop, but that's the end of their story. RamFactor provides many more powerful functions. It's the only slot 1-7 card that increases AppleWorks 2.0 internal limits by increasing the maximum number of records in the database to 22,600, increasing the maximum number of lines permitted in the word processor to 22,600, and expanding the clipboard size to 2,250 lines maximum. RamFactor is the only standard slot card that will automatically load all of AppleWorks into RAM, dramatically increasing speed and

eliminating the time required to access the program disk. It will even display the time and date on the AppleWorks screen with a ProDOS clock. RamFactor will automatically segment large files so they can be saved on multiple 5¼" and 3½" floppies or a hard disk. All this performance is available for the Apple IIe, Laser 128, Franklin or 64K Apple II Plus when used with an 80 column card. No other standard slot card comes close to enhancing AppleWorks so much.

The "Electronic Hard Disk"



RamCharger is an optional battery back-up device, (about the size of a disk drive), that can plug into a connector on RamFactor. With Ram-

Charger added to RamFactor, your program will appear almost instantaneously when you turn on your computer. RamCharger contains LED's that let you know RamFactor's reserve power status. Since RamCharger has its own built-in power supply, it can retain RamFactor's memory indefinitely. Plus, RamCharger's battery will continue backing up RamFactor's memory for up to 10 hours during power failures. An optional "Y" cable is also available that allows one RamCharger to power two fully expanded RamFactors.

If 1 MEG Isn't Enough



A 4 MEG RamFactor Expander can be plugged into the expansion port on RamFactor for up to 5 MEG's total. RamFactor Expander uses standard 1 MEG chips and can be expanded in 1 MEG increments. With the addition of RamCharger, both RamFactor and the expander will provide up to 5 MEG's of lightning-fast battery backed storage.

Features

- Compatible with Apple IIGs, IIe, II+, Franklin and Laser 128
- 256K to 1 MEG on main board with 256K

memory chips; expansion port supports up to 5 MEG with Expander option

- 100% Apple Memory Expansion Card compatible
- RamCharger battery back-up option available for permanent storage
- Reduces power strain to internal power supply with RamCharger option
- Fully socketed and user upgradeable
- Expands internal limits of AppleWorks 2.0
- Automatically recognized by ProDOS, DOS 3.3, Apple Pascal 1.3 and CP/AM
- Built-in RAMDrive software (true RAMdisk not disk caching)
- Graphic memory test included
- Allows Apple II+ to run AppleWorks 2.0 without buying additional software
- Automatically recognized by AppleWorks 1.3 and 2.0
- Fits in any I/O slot except slot 3
- 5 year warranty — parts and labor
- Proudly made in the U.S.A.

RamFactor with 256K	\$239
RamFactor with 512K	\$299
RamFactor with 1 MEG	\$419
RamFactor Expander with 1-4 MEG	CALL
RamCharger backup option	\$179
"Y" cable	\$24

(Allows one RamCharger to power two RamFactors.)

Order RamFactor today . . . with 15 day money back guarantee and our five year warranty. See your dealer or call (214) 241-6060, 9 a.m. to 11 p.m., 7 days, or send check or money order to Applied Engineering, MasterCard, VISA and C.O.D. welcome. Texas residents add 7% sales tax. Add \$10.00 if outside U.S.A.

AE APPLIED ENGINEERING™
The Apple enhancement experts.

(214) 241-6060

P.O. Box 798, Carrollton, TX 75006

Prices subject to change without notice.

NETWORK

Using a Null Modem

You may simply want to use AppleTalk to connect one printer to a close-in host. If the distance is very short and everything is plugged into the same grounded outlet strip, you can substitute a standard null-modem cable for the LocalTalk connectors.

This fourth cable solution appears in figure 4, which shows schematics for three null-modem

cables. One of these cables goes from a DB9 to a DB9 connector, one goes mini circular 8 to mini circular 8, and the final one is a DB9-to-mini-circular-8 adapter combined with a null-modem cable.

These cables are available from a variety of sources. Besides Redmond Cable, you might check out the Micro Computer Cable Compa-

ny. Null-modem cables can cost as little as \$5.50 in single quantities.

Once more, though: Do not use a null-modem cable as a LocalTalk substitute unless (1) only one computer and a single peripheral are in use and (2) both are always plugged into the same grounded outlet.

Cheater Cords

Figure 5 shows my final solution to the AppleTalk cable problem: an

Figure 4: You can use a null-modem cable if there are only two users on the line and if both are plugged into the same grounded AC outlet strip. This figure shows three variations.

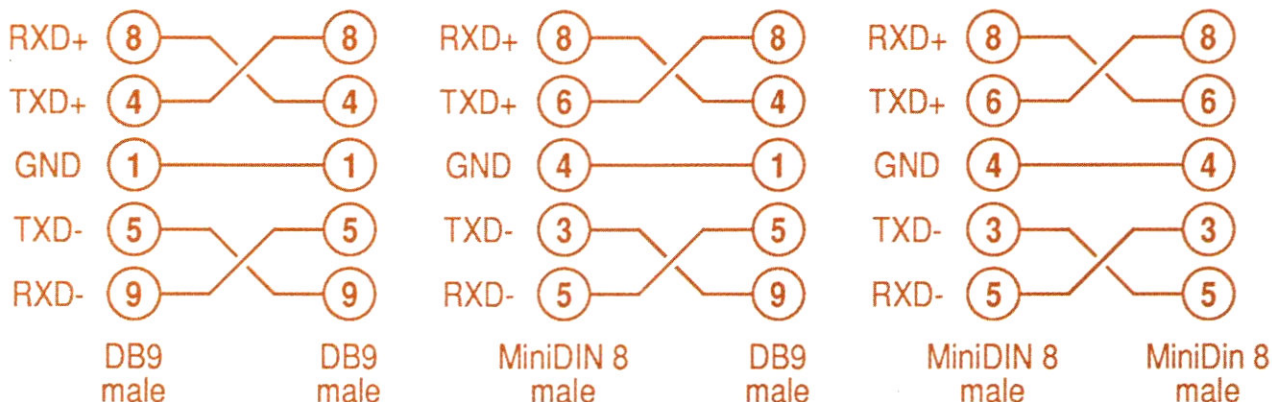

DISK DRIVES FROM \$99.95!

DISK DRIVES

AP-150

1/2 HT, DIRECT DRIVE

\$99.95

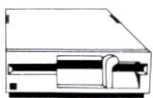

MAC535

3.5" ADD-ON DOUBLE SIDED 800K

\$199.95

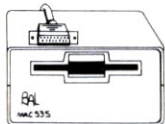

AD-3C

RELIABLE & FAST SLIMLINE DIRECT DRIVE

\$139.95

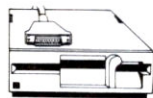

FDD CONTROLLER \$49.95

WORKS WITH APPLE DISK II ProDos COMPATIBLE

IC TEST CARD \$129.95

QUICKLY TESTS COMMON ICs TESTS: 4000, 74HC, 7400, 74LS, 74L, 74H & 74s ONE YEAR WARRANTY

EASYDATA EXTERNAL MODEMS

Both models feature auto-dial, answer, redial on busy, Hayes compatibility, power up self test, touchtone or pulse, built in speaker, Bell 103 & 212A half or full duplex and more.

1200 BAUD \$119.95

2400 BAUD \$219.95

11c MODEM CABLE \$14.95



EPROM PROGRAMMER



RP-525 \$59.95

16K RAMCARD

• EXPANDS 48K TO 64K
• 2 YEAR WARRANTY



\$39.95

CASE WITH KEYBOARD

For Apple type motherboard

- USER DEFINED FUNCTION KEYS
- NUMERIC KEYPAD W/ CURSOR CONTROL
- CAPS LOCK
- AUTO-REPEAT

KB-1000 \$89.95

JOYSTICK GC-10

- INCLUDES ADAPTOR FOR APPLE II, IIe & IIc
- SET X-Y AXIS FOR AUTO CENTER OR FREE MOVEMENT
- INCLUDES FIRE BUTTON

\$19.95

PRINTER \$219.95



POWER SUPPLY \$49.95

- +5V @ 7A,
- +12V @ 3A
- -5V @ .5A,
- -12V @ .5A



MONITOR STANDS

Attractive, sturdy, tilt & swivel models WITH POWER STATION WITHOUT POWER STATION

\$39.95 \$12.95

SWITCH BOX \$39.95



Visit our retail store located at 1256 S. Bascom Ave. in San Jose, (408) 947-8881

JDR Microdevices
110 Knowles Drive, Los Gatos, CA 95030
Toll Free 800-538-5000 • (408) 866-6200
FAX (408) 378-8927 • Telex 171-110

PLEASE USE YOUR CUSTOMER NUMBER WHEN ORDERING
TERMS: Minimum order \$10.00. For shipping and handling include \$2.50 for UPS Ground and \$3.50 for UPS Air. Orders over 1 lb. and foreign orders may require additional shipping charges - please contact our sales department for the amount. CA residents must include applicable sales tax. All merchandise is warranted for 90 days unless otherwise stated. Prices are subject to change without notice. We are not responsible for typographical errors. We reserve the right to limit quantities, and to substitute manufacturer. All merchandise subject to prior sale.



COPYRIGHT 1987 JDR MICRODEVICES

THE JDR MICRODEVICES LOGO IS A REGISTERED TRADEMARK OF JDR MICRODEVICES. JDR INSTRUMENTS AND JDR MICRODEVICES ARE TRADEMARKS OF JDR MICRODEVICES.

CIRCLE 167 ON READER SERVICE CARD

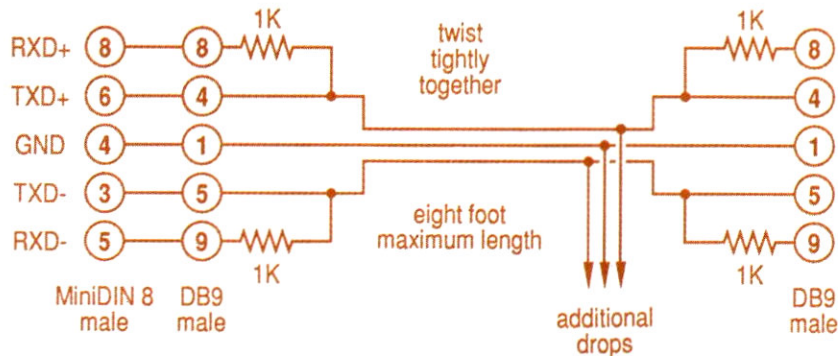

Figure 5: You can build this LocalTalk "cheater cord" at almost no cost. It lets you connect two, three, or more stations to the network. But all stations absolutely MUST be plugged into the same grounded AC outlet, and operation beyond a few feet is not recommended.

el-cheapo home-brew doorbell-wire substitute I use that fakes the cable and connectors for two, three, or more AppleTalk talkers and listeners. This "cheater cord" automatically adapts DB9 to mini circular 8 or vice versa.

As with a null modem, this method offers no safety isolation, so every talker and listener on the net must always be plugged into the same grounded outlet strip. I definitely would not try going

more than a few feet with such a setup, but it's certainly cheap and does work well when your local-area network is truly local. +

Microcomputer pioneer Don Lancaster is the author of 25 books and countless magazine articles. He maintains a no-charge Apple IIGS, PostScript, and laser-printing voice help line at (602) 428-4073. He welcomes calls from A+ readers, 8-5 weekdays, Mountain Standard Time.

FURTHER INFORMATION

AESP, Inc.
1680 N.E. 205th Terrace
North Miami Beach, FL 33179
(305) 653-0898

Farallon Computing
1442A Walnut Street #64
Berkeley, CA 94709
(415) 849-2331

Micro Computer Cable Company
16018 Huron River Drive
Romulus, MI 48174
(313) 941-6500

Monster Cable Products, Inc.
101 Townsend Street
San Francisco, CA 94107
(415) 777-1355

Redmond Cable
13761-A1 NE 67th Court
Redmond, WA 98052
(206) 882-2009

Scenery Disk # 11

Explore the Great Lakes

from Detroit to
Buffalo with

Scenery Disk # 11

Fly the fine

Flight Simulation

Products of

SubLOGIC

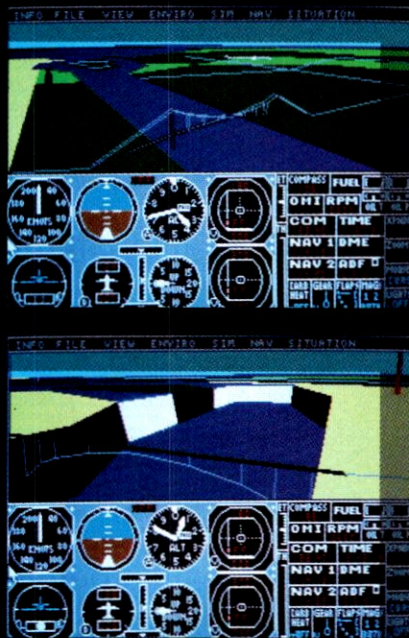

subLOGIC
Corporation
713 Edgebrook Drive
Champaign IL 61820
(217) 359-8482 Telex: 206995

ORDER LINE: (800) 637-4983

(except in Illinois)

CIRCLE 110 ON READER SERVICE CARD

PICK OF THE CROP
BY PETER TUCKER

This month brings you early-learning, macro-assembling, database-managing, desktop-publishing, and flight-simulating software.

PRODUCT SPOTLIGHT

DESKTOP PUBLISHING

From Timeworks comes Publish It!, an extensive desktop-publishing program that allows you to edit, design, lay out, and print attractive-looking documents.

The software's built-in layout tools allow you to

position and resize elements on the screen, seeing exactly what the finished document will look like. Publish It! includes sample formats for newsletters, business reports, brochures, and forms.

You enter text into documents directly with the built-in word-processing program, or you import it

from an AppleWorks or other ASCII text file. The program contains a graphic tool box for drawing lines, circles, or rules, as well as obtaining fill patterns. You can also import graphics from Dazzle Draw, The Print Shop, or other double-hi-res drawing packages.

Printouts are evidence of a high-density print format (72 x 120 dots per inch) that provides a clean, attractive ImageWriter original. The Publish It! Laser Pack, allowing LaserWriter printouts, is scheduled for release later this year.

Publish It! comes with six attractive typefaces, each available in a variety of point sizes. You'll also find

32 files of ready-made artwork, covering animals, people, signs, and symbols. **Publish It!**

List Price: \$99.95

Requires: Apple IIe, IIc, or IIGs; 128K RAM; mouse or joystick. 5¼-inch or 3.5-inch disk drive.

Timeworks
444 Lake Cook Drive
Deerfield, IL 60015
(312) 948-9200

CIRCLE READER SERVICE NO. 410

MAKE A LIST AND CHECK IT TWICE

Activision announces List Plus, a new database manager for the Apple IIGs.

With List Plus, you can maintain, organize, or report information—from simple address books to complex customer lists and sales records.

It gives you up to five different ways to display information, allowing you to switch immediately from one to another.

The program can read AppleWorks-compatible data and ASCII files automatically, with the record and file size limited only by available memory. Up to four different windows can be open at a time, which means you can work on multiple lists.

The List Plus package also comes with eight pre-designed templates ready for data entry, including an address list, class roster, customer and sales information, and home inventory. List Plus reports can print on an ImageWriter or LaserWriter.

List Plus
List Price: \$99.95

Requires: Apple IIGs; 768K RAM with 2.0 ROM installed, one 3.5-inch disk drive. ProDOS 16; not copy-protected.

Activision, Inc.
P.O. Box 7287
Mountain View, CA 94039
(415) 960-0410

CIRCLE READER SERVICE NO. 411

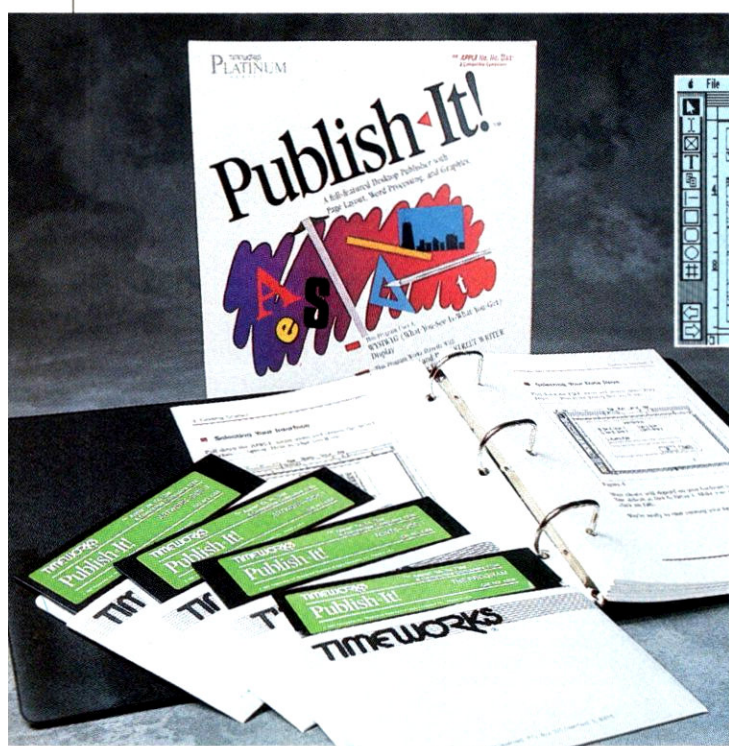
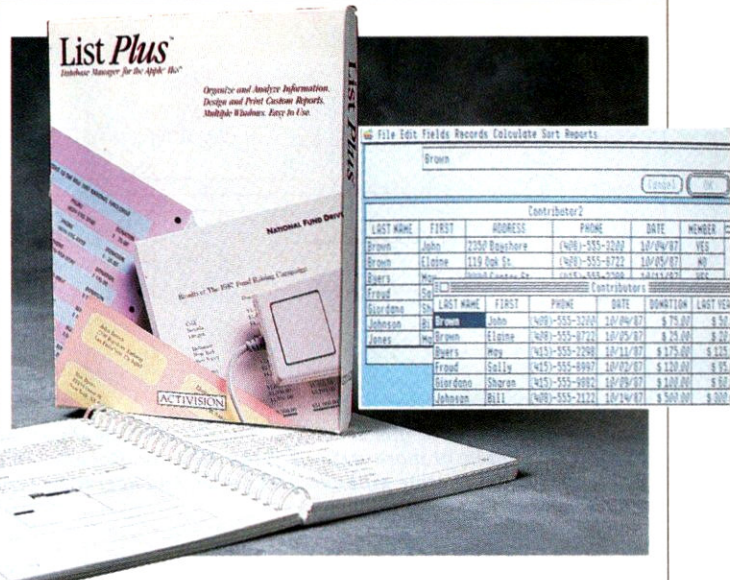

STEPPING STONES

Parents of children from 2 to 7 will appreciate Stepping Stones from Compu-Teach. Two separate packages, each with three colorful programs, provide a strong introduction to letters, words, and numbers.

Level I provides your preschooler with three complete learning programs. ABsCenes teaches the alphabet at three different skill levels, ArithMATIC: Counting introduces numbers and basic math concepts, and Word Pieces offers simple three-letter words and word sounds.

For children ages 5-7, Stepping Stones continues with Level II: fundamentals of words, math, and sentences. Like Level I, the package contains three different programs. Pictionary is an early-reading game,

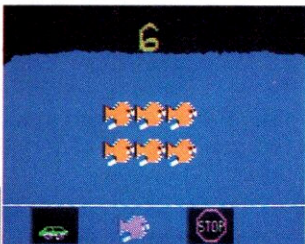
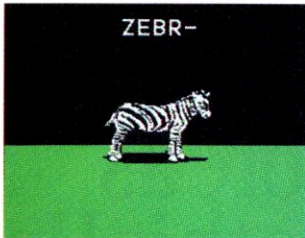

ArithMATIC Addition demonstrates addition as an extension of counting, and Sentence Wizard builds sentences associated with animated illustrations.

Stepping Stones Levels I and II

List Price: \$39.95 each
Requires: Apple II Plus, IIe, IIc, or IIgs; 64K RAM; one 5¼-inch disk drive.
 Compu-Teach Corporation
 78 Olive Street
 New Haven, CT 06511
 (800) 448-3224

CIRCLE READER SERVICE NO. 412

THE RIGHT TO ASSEMBLY

Designed for programmers working in assembly language, Micol Macro offers an integrated text editor, monitor/shell, and self-relocating macro-assembler package.

You create programs with the full-screen editor and then assemble them with the macro assembler. Communication with the system is via the monitor/shell.

Files the assembler creates are special Micol load files that accept multiple ORG statements. You can create relocatable programs that load at the lowest available area of memory or at the exact location you specify. In addition, you can create SYS files for loading by ProDOS.

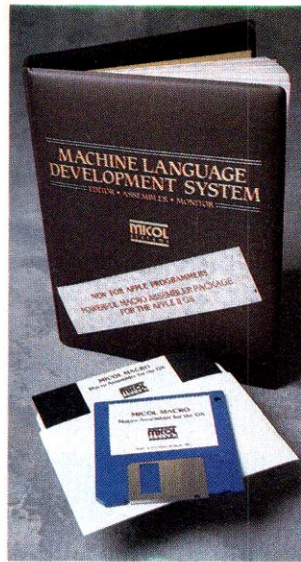

All commands—whether addressing the editor or macro assembler or communicating with the operating system—execute instantly. Returning to Micol Macro after testing your program requires just two keystrokes.

Micol Macro comes on both 3.5- and 5¼-inch disks, complete with extensive documentation and sample programs.

Micol Macro

List Price: \$49.95
Requires: Apple IIgs, 512K RAM, one 3.5-inch or 5¼-inch disk drive.
 Micol Systems
 9 Lynch Road
 Toronto, Ontario
 Canada M2J 2V6
 (416) 495-6864

CIRCLE READER SERVICE NO. 413

FLYING WITH FLIGHTSTICK

Whether you're out for a relaxing cruise in your Cessna or engaged in deathly combat in your F-15, FlightStick from CH Products gives you the look, feel, and action of the real thing.

FlightStick features a realistic, comfortable pistol grip, with convincingly smooth action. The strategic placement of the trigger and fire buttons gives you immediate tactile and audio feedback. You can also use the FlightStick with graphic applications, should the creative mood strike.

Other features include a five-foot cable, dual-axis trim controls, and linear potentiometers rated at four million life cycles (whatever that means!).

FlightStick

List Price: \$74.95

CH Products
 1225 Stone Drive
 San Marco, CA 92069
 (619) 744-8546

CIRCLE READER SERVICE NO. 414

FOR MORE PRODUCT INFORMATION, SEE "ROUNDUP," PAGE 134.

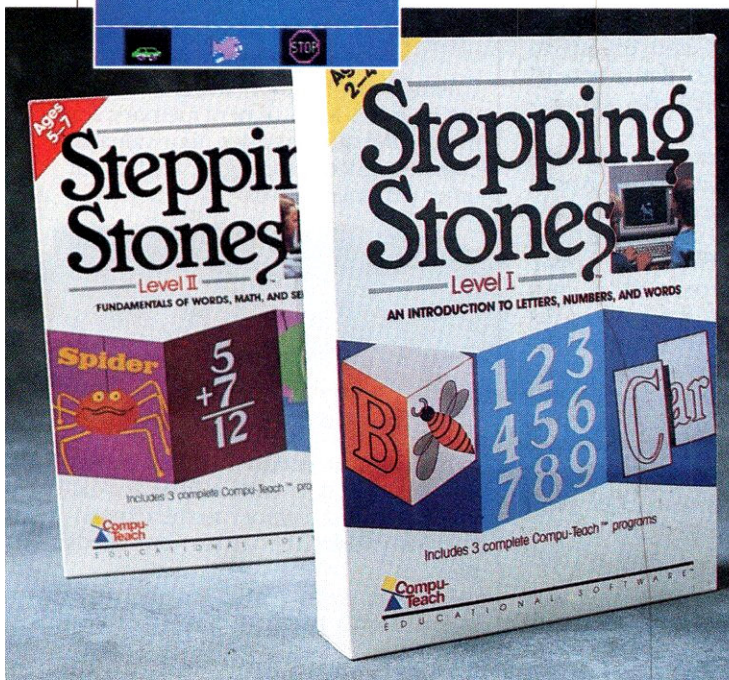



It takes
this many IIe's



to store as
much as this IIe.

Add up to 3 MEG memory with the RamWorks® III expansion board.

You command vast power with RamWorks III — up to 12 times more memory than your IIe came with.

You work faster, more efficiently. Your IIe does things it could never do before.

Memory intensive software like AppleWorks runs faster. You can put Pinpoint or MacroWorks *and* your spelling checker into RAM at the same time for instant response. And you can work with massive files without constantly going back to your disk drive.

Run AppleWorks 20 times faster.

With 512K or larger RamWorks, *all* of AppleWorks (including printer routines) automatically loads into RAM.

The result? AppleWorks runs up to 20 times faster. You don't waste time accessing the program disk drive. You switch instantly from word processing to spreadsheets to database. Anytime. And without wear on disk drives.

No other expansion board, not even

Apple's, gets so much out of AppleWorks.

RamWorks III gives you a huge AppleWorks desktop — 366K with the 512K RamWorks III and on up to 2251K with the 3 MEG RamWorks III (even after *all* of AppleWorks automatically loads in memory).

RamWorks eliminates AppleWork's internal memory limits. While AppleWorks 2.0 makes up to 6,350 database records available, you get up to 22,600 with RamWorks. Instead of AppleWorks' 7,250 word processing lines, you get up to 22,600 lines. And Clipboard capacity zooms from AppleWorks' 255 lines to 2042 lines.

RamWorks boards include an AppleWorks print buffer — up to 125K in the 512K model — so you can keep working while your printer is printing. Also, you don't have to buy a separate print buffer, a savings of up to \$250.00.

Autosegments large files.

RamWorks automatically segments large files so they can be saved on two

or more disks. When you need to work with the file, you simply load it in the same sequence you saved it.

Add up to 3 MEG without using a single expansion slot.

RamWorks III, even when it's carrying its full 3 MEG of new memory, fits in your IIe's auxiliary slot. Your valuable expansion Slots 1 through 7 are free for other peripheral cards.

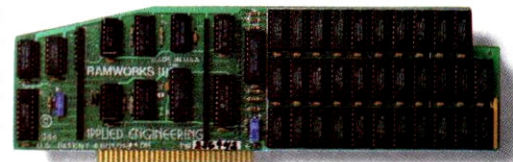

RamWorks III expansion board

If you don't need all of that power now, you can start with as little as 64K. It's easy to add memory to the expandable RamWorks III board as your needs grow.

You can go to 1 MEG on the main board using standard RAMs. That's

more memory than most people ever use. (1 MEG is about 500 pages of text.)

For even more power, snap an Applied 512K, 1 MEG or 2 MEG expander card into the RamWorks III low profile connector. The expander card won't interfere with Slot 1.

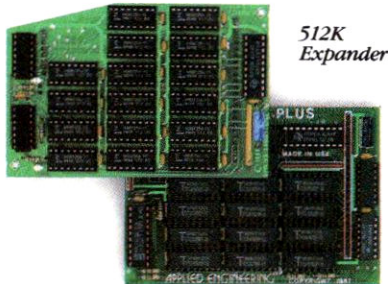

2 MEG plus Expander

Recover your investment in the wrong card.

Most of it anyway.

If you bought some one else's RAM card — one that's not recognized by your programs — RamWorks III can help recoup your loss. Pull the memory chips off your old card and plug them into RamWorks III.

Truly compatible.

RamWorks III is compatible with more off-the-shelf software than any other RAM card. It is recognized by all memory intensive programs.

Its power enhances AppleWorks, Pinpoint, Tax Preparer, Sensible Speller, ProFILER, Managing Your Money, SuperCalc 3a, VIP Professional and many, many more ... even software written specifically for Apple cards.

RamWorks III is compatible with most hardware add-ons like ProFile and Sider hard disks.

Of course, RamWorks III is fully compatible with all IIs — enhanced or unenhanced, American or European.



"I wanted a memory card for my Apple that was fast, easy to use, and very compatible; so I bought RamWorks"

Steve Wozniak, the creator of Apple Computer.

Easy to install and use.

RamWorks III quickly plugs into your IIs auxiliary slot. You get memory expansion and super-sharp 80 column text (U.S. Patent 4601018).

RamWorks III comes with every-

thing you need to get up and running. The easy-to-understand manual shows you how to get the most from your new memory. The two accompanying 5¼" disks include a graphics utility program, AppleWorks enhancement program, ProDOS and DOS 3.3 RamDrive™ and other useful utility software.

Superior color graphics, more readable text.

The ColorLink™ RGB option gives brilliant, sharp graphics and text.

It meets all Apple standards for RGB output control. So it's compatible with more off-the-shelf software.

You can use Apple or IBM RGB monitors. ColorLink provides Apple standard analog and IBM standard digital RGB outputs (cables included).

ColorLink offers four text colors so you can use the one that's easiest on your eyes (others offer only green).

The ColorLink option plugs into the back of RamWorks III. It doesn't interfere with Slot 1.

You can order ColorLink with your RamWorks III board or add it later.

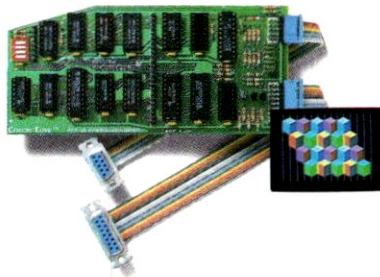

ColorLink® RGB option. IBM digital output cable. Apple analog output cable.

Optional 16 bit power.

You can explore powerful programming possibilities with Applied's optional 65C816 card. It's capable of linearly addressing more than 1 MEG.

It connects to RamWorks III's built-in CPU port. Instead of using another slot, Applied's 65C816 card simply replaces the 65C02. It maintains complete 8-bit compatibility.

The RamWorks basic® alternative.

Need power but not all the capabilities of RamWorks III? Look at RamWorks basic. It has the same performance features as RamWorks III, it's attractively priced and it's available with up to 512K memory.

Backed by the leader.

All RamWorks boards are backed by Applied Engineering's 15 day money back guarantee. And by our 5 year, hassle-free warranty.

Applied Engineering has been de-

signing and building Apple enhancements for over 8 years. We invented large RAM cards for the Apple. Today, our innovative technology leads the

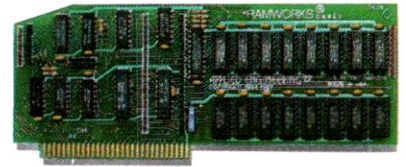

RamWorks basic® expansion board.

field. We sell more Apple enhancements than any one else, including Apple Computer. So you know we'll be around to solve problems and answer questions.

Order now.

See your dealer now. Or call Applied Engineering at 214-241-6060 between 9am and 11pm CST 7 days. Or send your check or money order to Applied Engineering. MasterCard, VISA and C.O.D. welcome.

RamWorks basic with 64K	\$ 149
RamWorks basic with 256K	\$ 179
RamWorks basic with 512K	\$ 239
RamWorks III with 64K	\$ 179
RamWorks III with 256K	\$ 199
RamWorks III with 512K	\$ 259
RamWorks III with 1 MEG	\$ 379
RamWorks III with 1.5 MEG	\$ 539
RamWorks III with 3 MEG	\$1399
512K Expander	\$ 219
2 MEG Plus Expander with 1 MEG	\$ 599
2 MEG Plus Expander with 2 MEG	\$1049
65C816 16 Bit Card	\$ 159
ColorLink RGB Option	\$ 129
Optional Software:	
Pinpoint with RAM Enhancement Software	\$ 79
VIP Professional, Enhanced Ii version	\$ 199

Prices subject to change without notice. Texas residents add 7% sales tax. Add \$10.00 if outside the U.S.A.

AE Applied Engineering
The Apple enhancement experts.

P. O. Box 798, Carrollton, TX 75006
(214) 241-6060

type

```
name = string[20];
```

```
House = record
```

```
  bedrooms: integer;
```

```
  baths: integer;
```

```
  den, kitchen, dining_room: b
```

```
  price: real;
```

```
end;
```

```
matrix = packed array [1..10, 1
```

```
  address = integer;
```

```
phone_number = record
```

```
  area_code, prefix: 0..999;
```

```
  number: 0..9999;
```

```
end;
```

TWO PASCALS

When the Apple IIGS first came out, you had to be an assembly-language jockey to write programs for it. Fortunately for those of us who want to program that machine in a higher-level language, several other programming options are now available, including two excellent versions of Pascal.

Pascal, a highly structured language designed to promote good programming habits, sees frequent use as an instructional language in an academic environment.

The two versions of Pascal for the Apple IIGS—Orca Pascal and TML Pascal—are both *compilers*. A compiler takes the program you have written in Pascal, known as *source code*, and converts it to the only real code the Apple IIGS understands, *machine language*. This

FOR THE IIGS

SOFTWARE BY MICHAEL FISCHER

*The Orca Pascal and
TML Pascal compilers*

conversion takes place as part of the programming process and results in a long development process but a fast-running program.

(By contrast, Applesoft BASIC and GS BASIC are both *interpreted* languages. The translation of the source code for these languages, which takes place when the program runs, results in a noticeably slower-running program.)

Editing Environment

TML Pascal comes in two versions. One runs under the shell of the Apple Programmer's Workshop (APW) and uses the editor and linker that come with that system. You must buy APW (available for \$100 from the Apple Programmers' and Developers' Association) or the Orca/M GS system to run this version of TML Pascal. Orca/M

is a programming environment that is almost the same as APW.

The other version of TML Pascal (known as TML Integrated) doesn't require APW and comes with a built-in editor; it functions as a full-fledged Apple IIGS desktop-style application. You use the mouse to make selections from the menu and enter the program text into one of several windows that can be open on the desktop. The compiler and linker are built into this system and are invoked when you select them from a menu. This version of TML Pascal is nearly, but not quite, the same as the APW version. One difference is that the APW version lets you link other files such as assembly-language code segments to your programs.

Orca Pascal, as of this writing (January 1988), comes in a version that runs either under APW, Orca/MGS, or by itself in an environment that is much like APW. Orca has also announced a desktop version, much like the TML integrated version. I was able to review a beta-test version of this latter program while writing this article. You should carefully check any statements I make here about features of the desktop Orca Pascal against the actual released version of the program.

The APW shell, under which Orca Pascal and the APW version of TML Pascal run, is a powerful development environment. It is also complex. If you are an experienced programmer who needs substantial power, you should consid-

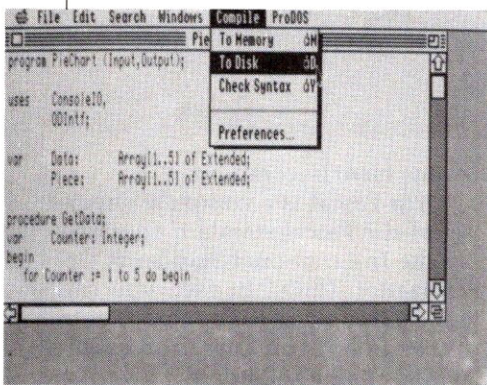

TML Pascal compiles to memory or disk.

er the APW versions of Orca or TML Pascal. Otherwise you should consider the integrated or desktop versions. I will not be reviewing the operating environments for the APW versions of the programs because they are the same.

MENU FUNCTIONS IN BOTH ORCA PASCAL AND TML PASCAL

File actions

- New
- Open
- Close
- Save
- Save As
- Revert
- Delete
- Quit

Edit actions

- Undo
- Cut
- Copy
- Paste
- Clear
- Select All

Window actions

- Tile
- Stack

Find actions

- Find
- Replace
- Goto

Other actions:

- Compile to memory
- Compile to disk
- Check for errors

Significant Differences

The table above lists the system commands common to the desktop versions of both programs; despite these similarities, the two systems have significant differences.

TML Pascal allows you to compile a new desk accessory (NDA) and test it without placing it in the desk-accessory folder and rebooting the system. This capability saves you much time when you're developing and testing an NDA. TML Pascal also allows you to rename a file, launch another program without returning to the Finder, and get information such as the source-file size and the amount of free memory in your IIGS. These features are absent in Orca Pascal.

Orca Pascal has its own unique features, too. It comes with a set of debugging commands that permit you to track down errors in your programs. You can step through the code; use break points; and examine variables, the stack, and

memory. If you have a fairly large or complex program, this feature will prove invaluable. (A debugger is also available for use with APW.)

Orca Pascal also has commands for formatting your source code: shifting blocks of code left or right on the screen, changing from the Overstrike to the Insert mode, and setting tabs by means of a ruler.

Orca Pascal allows you to select between an ImageWriter and a character-oriented printer. If you select a character-oriented printer, you must also specify the line length and number of lines per page. By contrast, TML Pascal is designed to send its output only to an ImageWriter printer. It has no Page Setup command, and, when you choose the Print command, printing starts immediately.

The two different approaches to the printing function represent different philosophies about who is likely to use the desktop system. Orca can accommodate almost all

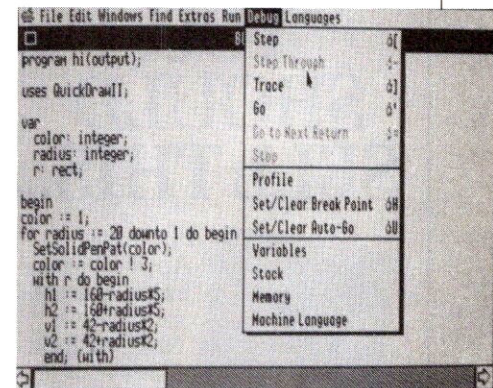

Orca Pascal comes with a set of debugging commands.

users, at the price of requiring some additional actions of everyone. TML, on the other hand, accommodates the more typical users of the system without needing much, if any, extra action.

These two approaches also appear in the type of material that each desktop system handles. The Orca desktop system is supposed to be fully compatible with any APW language and source-code file. You can edit source code and compile, link, and run the programs—all from the desktop system. The Orca desktop system functions as a replacement for the APW editor and shell. (Technically, though, the desktop environment is called from the shell, and when you quit from the system, you return to the APW shell.)

ATTENTION RETAILERS!

**BECAUSE
YOU SELL
ONE OF
THESE...**



**YOU
SHOULD
SELL THIS...**

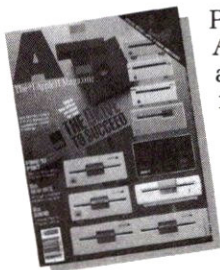

Put the #1 Apple II Magazine to work for you! A+ MAGAZINE, the #1 Apple II magazine, is your "silent

salesman" introducing your Apple II customers to new Apple II products every month!

A+ is the best way to increase the sale of new Apple II hardware and software—every issue contains in-depth coverage of new entertainment packages... educational applications... business software and hands-on tutorials that promote your inventory!

Give your customers the "insider information" that can only be found in A+! To place your order for A+ call 212-503-5380 today or write:

**Ziff-Davis Publishing Company
Retail Sales Department**
One Park Avenue—4th Floor
New York, NY 10016

PASCAL COMMANDS IN BOTH ORCA PASCAL AND TML PASCAL

Directives

External
Forward
Tool

Statements

Case [otherwise]
Code segment
Data segment
For ... to/downto ... do
Goto
If ... then ... [else]
Repeat ... until
Uses
While ... do
With ... do

File procedures/functions

Close
EOF
Eoln
Page
Read
Readln
Reset
Rewrite
Seek
Write
Writeln

**Memory allocation
procedures/functions**

Dispose
New

**Ordinal
procedures/functions**

Chr
Odd
Ord
Pred
Succ

Conversion

procedures/functions

Ord4
Pointer
Round
Trunc

Math

procedures/functions

Abs
Arctan
Cos
Exp
Ln
Sin
Sqrt

String

procedures/functions

Concat
Copy
Delete
Insert
Length
Pos

**Bitwise manipulation
procedures/functions**

And
Not
Or
Shift left
Shift right
Xor

Miscellaneous

procedures/functions

Halt
Tool error number

The TML system is designed for one purpose, developing programs for the Apple IIGS in Pascal. The Pascal compiler is built into the system, and it automatically handles the linking of files when you select the Compile command.

Command Differences

The two programs, though, differ in more than just their design. Both programs have most of the commands you would expect in a Pascal compiler, but each also has certain commands that the other lacks. The table above lists all of the Pascal commands that the two pro-

grams have in common.

Orca Pascal is a complete superset of the Pascal standard specified by the International Standards Organization (ISO). In fact, you can issue a command to the compiler to flag as an error any use of an extension to the ISO standard.

If you are writing programs that are to be completely portable from one operating environment to another, you may find this ISO-compatibility feature significant. Of course, adherence to the ISO standard prevents you from using any of the IIGS tools, including the desk-

top system of windows and menus.

The first figure on the next page lists the commands that are available only in Orca Pascal, and the second figure lists the commands that are available only in TML Pascal. These lists are subject to much change, since the two programs are undergoing substantial revision and are each likely to incorporate the more useful features of the other.

The missing commands (marked in the tables with an asterisk) are not, for the most part, that significant. Indeed, you can create most of them by simply writing your own procedure or function. When you need certain other commands (marked in the tables with an @), you can create them by using Apple IIGS toolbox calls, either individually or in conjunction with other Pascal commands.

Compiler Differences

The two compilers each take Pascal source code and turn it into object code. The object code is then linked into applications or desk accessories by the linker. In the TML desktop system, the linking occurs automatically. With the Orca desktop system, you can specify that the linking occur without further intervention if you issue the proper compiler directives and set the desktop system appropriately.

The version of TML Pascal for APW (version 1.5) whose release is expected by the time this article is printed will have the ability to generate 65816 assembly-language source code as well as object code. Thus, if you are proficient in 65816 assembly language, you will be able to fine-tune some of the code the compiler generates.

The Orca compiler is an optimizing compiler; that is, it creates object code that functions in the most efficient manner. Optimization, though, takes time. Fortunately, you can tell the Orca compiler to postpone optimization during the development phase, waiting until you have the program working the way you want before you perform the optimization.

Other Features

The Orca Pascal disk comes with a samples disk that contains a working desktop program, an Othello game, several graphics programs, some text programs, and desk accessories. The samples disk

HIGH GRADE FUEL.

NEW

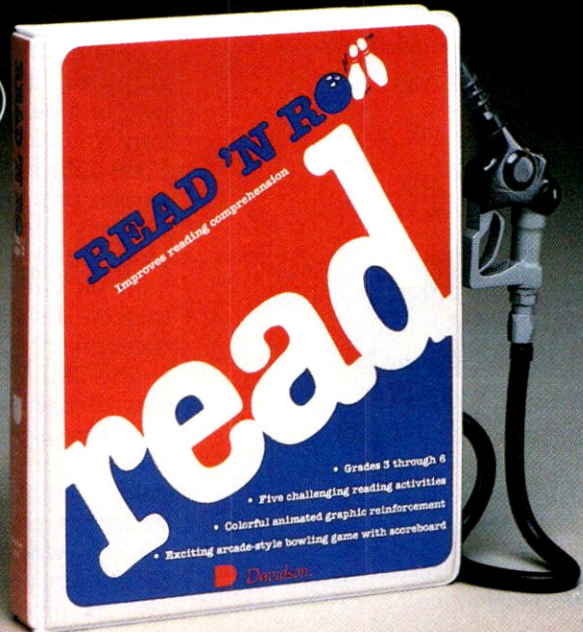

Davidson's new Read 'N Roll is the highest octane reading software program you can buy for your kids. Formulated by teachers to grow with kids and help them develop the 5 basic reading comprehension skills.

Read 'N Roll pumps in confidence and love of reading, and prints out Certificates of Excellence.

With 320 high-interest reading passages, exciting graphics and color, and an action-packed arcade-style game, Read 'N Roll makes reading fun. And new pull-down menus are easy to use with keyboard or mouse.

So pull into your local software dealer and pick up the highest performance

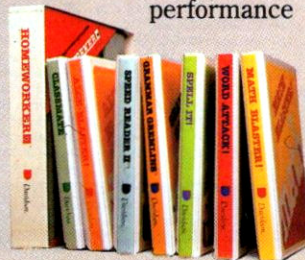

REPORT CARD	
MATH	A
READING	A
SPELLING	A

reading software around—
Read 'N Roll.

Call us toll-free for more information and the name of the Authorized Davidson Dealer nearest you.

800-556-6141 or 213-534-4070
(California residents)

For grades 3 through 6
Available for Apple® and IBM®
\$49.95 suggested retail

Return this coupon to enter our monthly drawing for \$100 worth of free Davidson software.* We'll also send you more information about all the high grade programs available from Davidson. A+ 5/88

Name _____

Address _____

City, State, Zip _____

Type of Computer _____

Davidson & Associates, Inc.
3135 Kashiwa St., Torrance, CA 90505

*NO PURCHASE NECESSARY. Offer ends Dec. 31, 1988. Void wherever prohibited or restricted by law. Odds of winning will be determined by total number of entries received.

©1987 Davidson & Associates, Inc.



Davidson.

CIRCLE 338 ON READER SERVICE CARD

COMMANDS EXCLUSIVE TO ORCA PASCAL

File commands

- * Get
- @ Open
- * Put

Conversion commands

- * Integer to string
- * Real to string
- * String to double precision real
- * String to integer
- * String to long integer
- * String to single precision real

Math operations

- * Arccos
- * Arcsin
- * Arctan2
- * Exponent
- @ Random
- @ RandomDouble
- @ RandomInteger
- @ RandomLongInt
- Seed
- * Sqr
- * Tan

Desktop environment and operating system commands

- Commandline
- @ EndDesk
- @ EndGraph
- ShellID
- @ StartDesk
- @ StartGraph
- SystemError

Fortunately, these programs are all very good.

also contains the source code for the Pascal run-time library and for the toolbox interface files, as well as macros for use in the passing of parameters to assembly-language subroutines.

The TML program comes with several sample files on disk that demonstrate the various aspects of programming the IIGS, including graphics, desktop environment, text, and desk accessories. In addition, you can buy the TML Source Code Library, which contains examples of using nearly all the IIGS tool sets. TML Systems is currently considering packaging much of the Source Code Library material in a tutorial disk that will come with the main program.

The TML Speech Toolkit enables you to use synthesized sound in your Pascal program. The disk contains three new tool sets (male voice, female voice, and text-to-phonetics parser), an interface file for use when calling the speech tools from your program, and several example programs showing the use of the speech tools. The speech tools produce sounds synthesized and is thus significantly lower in quality than digitized speech. It also takes up significantly less memory space and is more versatile than digitized speech. The

COMMANDS EXCLUSIVE TO TML PASCAL

Directives

Inline

File commands

- @ Erase
- FilePos
- @ IOResult
- @ Rename

Math commands

- * Dec
- * Inc

Bitwise commands

- * Rotate left
- * Rotate right

Other commands

- * Cardinality
- Cycle
- * Exit
- * FillChar
- * HiWord
- * Leave
- * LoWord
- * MoveLeft
- * MoveRight
- * Scan for matching character
- * Scan for non-matching character
- Sizeof
- @ Tool error occurred

ZIMCO

INTERNATIONAL, INC.

85-39 213 St., Queens Village, NY 11427

*** HARDWARE ***	*** SOFTWARE ***	*** HARDWARE ***	*** SOFTWARE ***
LASER 128 Computer.....\$365	JOYSTICK for Ile.....\$33	LASER 128EX Computer.....\$449	KRAFT 3-but. Joystick.....\$36
APPLE IIGS Computer.....\$819	Kensington System Saver.....\$62	Applied Engineering.....\$99	SYSTEM SAVER IIGS.....\$79
RGB ColorLink.....\$59	OM Pro-Grappier =Ilic.....\$79	RAM/WORKS III 256K.....\$155	OM Pro-Grappier w/buffer.....\$115
RAM/WORKS 512K.....\$155	Parallel Printer Interface.....\$40	GS-RAM 512K.....\$225	Parallel Pro.....\$65
PC Transporter's.....\$79	SCall Graphics Printer Card.....\$55	Viewmaster80.....\$110	Extended 80 col. for Ile.....\$29
Z-RAM ULTRA #1 512K.....\$225	SUPER SERIAL CARD.....\$59	Viewmaster100.....\$179	16K RAM CARD.....\$35
#2, \$210.....\$225	Surge Suppressor w/6 outlets.....\$190	Apple IIE MOUSE.....\$119	and circuit breaker.....\$24
Apple IIE MOUSE.....\$119	ThunderScan(Ilgwtr).....\$190	APLUS MOUSE Ilic,Mac.....\$79	AST VISION IIGS.....\$290
DISKETTES (Box of 10).....\$7	*** MONITORS ***	3.5" Maxell MF2SD/DD.....\$21	APPLE Color Comp.....\$299
3.5" Verbatim DS/DD.....\$21	APPLE Color RGB.....\$399	3.5" Verbatim DS/DD.....\$21	APPLE Monochrome.....\$129
Verbatim 3.5 Cleaning Kit.....\$15	Amber Monochrome.....\$129	Disk Storage 100.....\$11	Tompson hi-resolution RGB.....\$250
Fan & Surge Prot.....\$24	540 x 240 pixel.....\$250		

*** SOFTWARE ***	*** SOFTWARE ***
If it's not here call us!	Pinpoint IIGS Starter Pack.....\$97
APPLEWORKS v2.0.....\$197	Pinpoint Spell Checker GS.....\$67
ASCII EXPRESS ProDos.....\$70	Print Shop COLOR.....\$33
BANK STREET WRITER PLUS Ilic \$48	Print Shop Compan.....\$23
BAUDVILLE 816 PAINT.....\$40	Print Shop Gr. Lib.1/2/3.....\$15
CLIPART vol.1.....\$16, vol.2.....\$23	PRINT SHOP IIGS.....\$36
DEFENDER OF THE CROWN.....\$31	Sensible Grammar.....\$53
DELUXE PAINT IIGS.....\$73	Sensible Speller ProDos.....\$64
FANTAVISION Broderbund.....\$36	SHANGHAI.....\$27
FONTWORKS/AUTOWORKS.....\$37	SIDEWAYS Funk Software.....\$43
GRAPHIC WRITER IIGS.....\$109	Talking Textwriter IIGS.....\$150

APPLE IMAGEWRITER II \$465
LASER 128EX—\$469
7TH YEAR ANNIVERSARY SALE
CMS SD20 HARDDRIVE \$632
MIDI HARDWARE & SOFTWARE

Graphics Edge.....\$69	TASS TIME In TONETOWN.....\$25
HACKER IIGS.....\$25	TOP DRAWER IIGS.....\$63
HITCHHIKER'S GUIDE Infocom.....\$18	VISUALIZER IIGS.....\$75
INSTANT MUSIC IIGS.....\$37	WIZARDRY Sirtech.....\$30
Midscape KING OF CHICAGO.....\$29	WORDPERFECT IIGS,e.c.....\$85
Managing Your Money MECA.....\$90	*** MIDI SOFTWARE ***
MIGHT & MAGIC IIGS.....\$34	Mastertracks IIGS.....\$170
MUSIC CONSTRUCTION IIGS.....\$38	Sonus Super Sequencer.....\$197
MUSIC STUDIO IIGS.....\$54	Sonus Pers. Musician IIGS.....\$87
NEWSMAKER.....\$55	PASSPORT Polywriter.....\$205
NEWSROOM.....\$33	Passport Music Tutor.....\$159
PAINTWORKS PLUS IIGS.....\$54	*** MIDI INTERFACE ***
PINPOINT.....\$46	PASSPORT, w/tape sych.....\$135

FREE SHIPPING ON ALL ORDERS*

CENTRAL POINT 3.5" Drive I187.....\$187	Controller \$69
CMS Hard Drives for Ile/IIGS SC20-A2S \$705; SC40-A2S \$1000	
CMS Stack Drive for Ile/IIGS SD20-A2S \$632; SD43-A2S \$830	
Genuine Apple 3 1/2" 800K drive (IIGS/Mac).....\$299	
Apple UniDisk 3.5 w/Catalyst (IIC,IIE,II+).....\$339	
App. Eng. 5 1/4" - 1 yr.warr.\$110	Contlr.\$46
Genuine Apple 5 1/4" drive Ile,Ilic,IIGS.....\$236	

*** PRINTERS ***	*** MODEMS ***
APPLE LASERWRITER.....\$3885	APP. ENG. DATALINK 300/1200bps Int. for II+/e/GS.....\$169
APPLE IMAGEWRITER II.....\$465	HAYES SmartModem 300 (Ilic).....\$172
CITIZEN 120D \$189	HAYES SmartModem 1200A \$308
OKIDATA 192 + p. \$315, s. \$389; #193 + p. \$465, s. \$532	HAYES SmartModem 2400-call
PANASONIC KXP-1080I \$call	HAYES Compatible External 1200bps Scall.....\$2400
Panasonic KXP-1592 \$439	US ROBOTICS Courier 2400.....\$359
STAR NX-1000 Parallel.....\$205	

1-800-227-6647

Inquiries, Tech Support & New York:

Call 718-479-7888

Free shipping via United Parcel or USPS ground service anyplace in the continental UNITED STATES. *Add insurance and handling fee to all orders. We cannot guarantee prices or weather; both tend to change. Call for current prices & sale flyer. Minimum restocking fee 20%.

speech tool sets were developed by First Byte, Inc., of Long Beach, California, developer of the Smooth-Talker program for the IIGs. If you intend to distribute software using the speech tool sets, you must get a license from First Byte.

Determining which of these four Pascal compilers is the best one and deciding which one to buy is not an easy matter. There is no clear-cut choice unless you need a compiler that is fully ISO-compatible, in which case you need one of the the Orca Pascal compilers.

If you will be programming in a combination of assembly language and Pascal, you should consider either of the Orca Pascals or the APW version of TML Pascal. The desktop version of TML Pascal cannot handle that combination. On the other hand, if you are relatively new to programming and do not wish to contend with extra complexity and power, you should consider the desktop version of TML Pascal, the simplest to use of the four programs. The desktop version of Orca is a bit more complex, and the APW versions of both programs are the most sophisticated.

VITAL STATISTICS

Apple IIGs Debugger

Apple Programmers' and Developers' Association
290 S.W. 43rd Street
Renton, WA 98065
(206) 251-6548

List Price: \$100; Apple IIGs Debugger, \$15.95

CIRCLE READER SERVICE NO. 361

Orca Pascal and Orca/M Gs

The Byte Works, Inc.
4700 Irving Blvd., NW, Ste. 207
Albuquerque, NM 87114
(505) 898-8183

List Price: APW, \$125; desktop version, \$150; Orca/M Gs, \$69.95

CIRCLE READER SERVICE NO. 362

TML Pascal for APW (requires APW or Orca/M Gs), TML Source Code Library, TML Speech Toolkit

TML Systems
8837-B Goodby's Executive Drive
Jacksonville, FL 32217
(904) 636-8592

List Price: \$125; integrated version, \$125; TML Source Code Library, \$49; TML Speech Toolkit, \$69

CIRCLE READER SERVICE NO. 363

Cost is another consideration. The least expensive products that work by themselves are the desktop version of TML Pascal (\$125) and the APW version of Orca Pascal (\$125). As stand-alone products, each of these Pascals gives you a development environment and a Pascal compiler. It costs extra to get an assembler (\$100) for working with assembly language with Orca Pascal; you can't work in assembly language with the desktop TML Pascal. The cost of a combined assembly-language and Pascal environment is the same with either of the APW versions of the two products. The desktop version of Orca Pascal costs the most (\$150).

Fortunately the programs are all very good. In this case, you are unlikely to make a bad choice. You should carefully consider your needs and compare them against the features of each of the compilers. Then base your choice on a balance of which features of which program you need most. +

Michael Fischer's most recent book is Apple IIGs Technical Reference, from Osborne/McGraw-Hill.

THE PERFECT PROMOTIONAL TOOL!

Quality reprints* of articles appearing in this magazine are available and will be custom designed to meet your special requirements.

For full details contact:
Jennifer Locke—
Reprints Manager,
Ziff-Davis Publishing
Company, One Park
Avenue, New York, NY
10016, 212-503-5447.

* Minimum quantity—500 reprints.

COPY II PLUS[®]

Includes
3.5" & 5.25"
Disks

THE BEST, MOST COMPLETE ProDOS-DOS UTILITIES.

■ **New memory manager** - uses available RAM to copy disks much faster. ■ **Copy** files, disks, even entire subdirectories. ■ **Undelete** ProDOS and DOS files. ■ **Tree display** for selecting subdirectories. ■ **Alphabetize** catalog. ■ **Convert DOS to ProDOS** and vice versa.

BACKUP PROTECTED 5.25" AND 3.5" SOFTWARE.

- Simply type in the name of the program you want to backup and COPY II PLUS does the rest.
- Backups of many titles can be transferred to a hard disk.
- Parameters for hundreds of programs are right on disk. Also includes a track editor, sector editor and HI-RES disk display.
- IIGS compatible - includes 3.5" disk.
- Runs on all Apple II models and Laser 128. Requires at least 64K and one drive. 3.5" bit copy requires an Apple //e enhanced, IIGS or Laser 128EX and one 3.5" IIGS, Laser or Chinon drive.

only \$39.95!

To Order COPY II PLUS VERSION 8:

☎ Call 503/244-6036, M-F, 8-5 (West Coast time) with your   in hand.

Or send a check for \$39.95 U.S. plus \$3 s/h, \$8 overseas.

Questions? Call us at 503/244-5782.

Central Point Software, Inc.

9700 S. W. Capitol Hwy.
Portland, OR 97219

CIRCLE 248 ON READER SERVICE CARD

10

Not-So-Sketchy Reasons To Invest In CADAPPLE

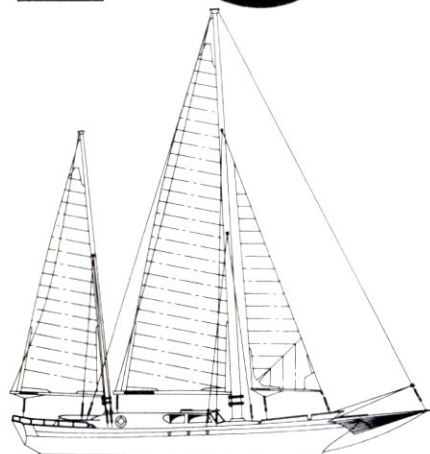

1 PROVEN You can't afford to invest time and money in a system that can't deliver. CADAPPLE's proven that it delivers: Since 1982 thousands of universities, colleges, and businesses have relied on CADAPPLE for professional computer-aided drafting.

2 FULL-FEATURED To draft your ideas, you need more than just an enhanced drawing package. You need a tool that furnishes full-featured CAD for basic production techniques. CADAPPLE is the only full-featured CAD system on Apple® II.

3 PRODUCTION-LEVEL CADAPPLE's production-level features such as Bezier curves, grouping, dimensioning, and sophisticated parts libraries afford you the CAD capability a serious drafter demands.

4 HIGH PRECISION CADAPPLE's floating-point decimal math operation provides you with the high-precision you need to build intricate parts.

5 EASY-TO-USE Your introduction to professional CAD will be easy with CADAPPLE. Our menu-driven system guides you step-by-step through each stage of your project. Coupled with context-sensitive help screens, these features make CADAPPLE easy to learn and use.

6 VERSACAD FAMILY Designed by Versacad, the CAD value leader, CADAPPLE belongs to an impressive family of professional systems. Your CADAPPLE experience will prepare you to move up to even the most sophisticated CAD systems.

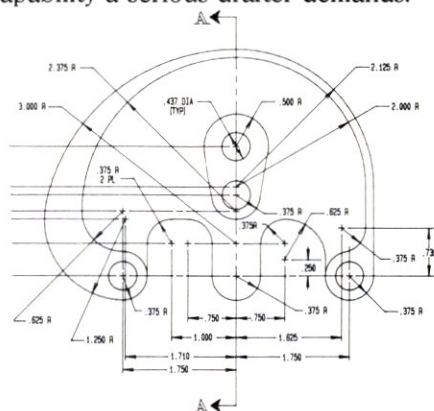

7 TIME-SAVER When you're investing time in a project, you can't afford to waste it. That's why CADAPPLE saves you screen redraw time by allowing you to control 250 independent drawing layers selectively. You'll also save time with single keystroke commands.

8 WELL-SUPPORTED Whether you're just starting out or tackling complex concepts, you can depend on our top-rated technical support department.

9 COMPLETE CADAPPLE includes a full range of large scale system features, such as: Virtually unlimited zoom • Failsafe drawing recovery • Wide range of primitive objects • 15 screen colors on Apple IIGS.

10 \$395 An investment in your future warrants the best. And our new low price can't be beat.

SYSTEM REQUIREMENTS:

Apple IIe with 128K and two disk drives

Apple IIc with internal drive and one external drive

Apple IIGS with two disk drives (Color monitor optional)

Joystick, Apple Mouse, or popular digitizers

Popular pen plotters up to E-size (37" x 81")

Invest in your future today.

Call Versacad with your VISA or MasterCard order: (714) 960-7720.

Or, mail a check or money order payable to

"Versacad Corporation":

2124 Main Street,

Huntington Beach,

CA 92648.

Versacad Corporation
A Company of Prime Computer, Inc.

The Memory Saver

BOARD

Faster than a speeding disk drive

Now you can boot your Apple IIGs faster than a speeding hard-disk drive and be looking at the Finder in 20 seconds instead of 96 (or have AppleWorks ready to use in less than 10 seconds). This feat is possible with Checkmate Technology's MemorySaver board, which can best be thought of as an independently powered expansion bus for the memory-expansion slot on the Apple IIGs.

You can attach your existing memory card, plus another one from a different manufacturer, to the MemorySaver board (see figure 1 for a list of compatible RAM cards) and partition all or a portion of the RAM as a battery-backed-up RAM disk called /ROM. Once you've installed the /ROM volume, the information on it remains in place when the power is off.

All-in-One Package

The MemorySaver system comprises a MemorySaver board, wall transformer, battery holder for six rechargeable batteries, power connector, configuration software, program selector, and manual. Installation is simple and straightforward. Plug your memory card(s) into the MemorySaver, one on the front and the other on the back, and plug the MemorySaver into

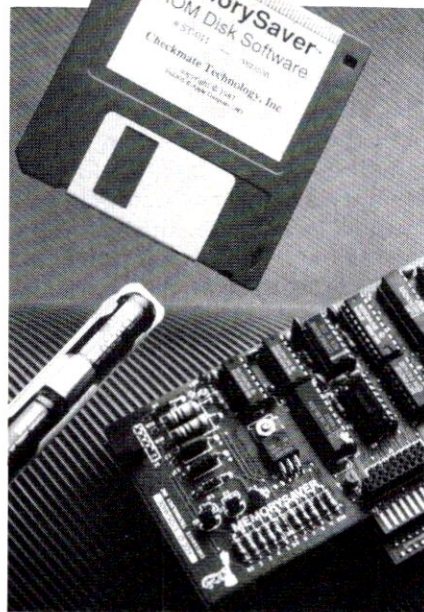

Checkmate's MemorySaver system

the memory-expansion slot. (For certain cards, you may need the MemorySaver slot-extender option for an additional \$39.95.) Put the battery holder under the power supply, install the insulating paper between the case and the memory card, hook up the power connections, and you are finished. A word of caution: *Do not* forget to install the piece of insulating paper between the side of the GS case and

your memory card. If you don't install it, severe damage to your GS could result.

/ROM Size

To set up your ROM disk, run the MemorySaver program that comes with the system. You can make the /ROM volume any size, up to the maximum GS memory limit of eight megabytes or the amount of RAM available on your memory card(s). To determine the amount of memory to dedicate for the /ROM volume, you need to decide what files you want to have available at startup. If you use a program selector such as MouseFiler or ProSel, you will want ProDOS and your selector program. If you want to use the Finder, you will need the files in figure 2. This configuration requires a 421K ROM disk, which leaves 859K for program execution on a machine with a one-megabyte memory card. This amount of free memory is more than adequate for all the current ProDOS 8 and ProDOS 16 system programs.

Once you've selected the size of /ROM, you select Install at the menu prompt. Your ROM disk will be ready to use as soon as you re-

GREAT SOFTWARE!

Public Domain and Shareware

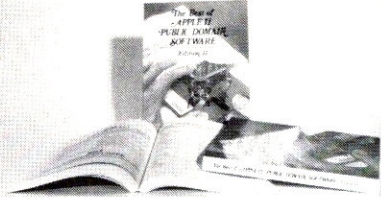

The Best of Apple, 350 pages (plus \$2 s/h) \$9.95

APPLE IIgs 3 1/2" DISKS

- GS1 Diversi Utilities: Diversi-Cache/Copy/Key/Hack 1.6 (shareware) \$9
- GS2 Desk Accessories — Notepad, Calendar, Diskinfo, install more than 12 DAs \$9
- GS3 More DAs! Setspeed, Setslot, Picsaver \$9
- GS4 Watch your screen melt! + 6 more DAs \$9
- GS5 Graphic utilities: convert pictures from any computer to IIGS format \$9
- GS6 Freeterm telecom.: rated A+ Mag's 1987 "All Stars." needs 512K \$9
- GS7, GS8, GS9 Lots of pictures to run with PaintWorks Plus, Deluxe Paint II, or our GS5: Alien, MaxHeadroom (3 disks) .. \$27
- GS10 Songs: Beethoven, Beatles, + more, for use w/Music Construction Set \$9
- All 10 for Only \$49.95

APPLE II 5 1/4" DISKS

- CAD**
- 310/311/312 CAD & graphing pkg. (3 disks) .. \$15
- Genealogy**
- 192 Family Tree Surgeon, hi res movies \$5
- Business/Home**
- 039 G/L, 15 financial programs, payroll \$5
- 056 Versatile check balancer, w/doc. \$5
- 404 Personal & home accounting \$5
- 406 Address/phone Dbase w/RAM drive \$5
- Word Processing**
- 037 Freewriter (II+ needs paddles or joystick) \$5
- Education**
- 062 Alphabet, spelling, word games \$5
- 064 Drills: typing, spelling, history, SAT \$5
- 066 Teacher aid: grader, make tests \$5
- 069 Geography, fractions/decimals \$5
- 085 Elem math: +, -, x, ÷, 23 levels \$5
- 502 Flash cards, speed reading, Spanish \$5
- 602 Genetics, anatomy, biology \$5
- 605 Chem: gases, acid/base, quant mech \$5
- Games**
- 123 Missile Command, Star Trek, Life \$5
- 126 Anti-Gravity—Fast action—Addictive! \$5
- 127 Defender (like arcade version), D-Day \$5
- Tutorials**
- 000 Integer BASIC & mini assembler \$5
- Art**
- 023 Make drawings, paint with 23 textures \$5
- 026/027 Make animated movies! (2 disks) \$10
- Communication**
- 264 A+ Mag's "ALL STAR": Talk Is Cheap telecommunication program (shareware) .. \$5
- 267/268 BBS system; create terminal programs + BBSs. (2 disk set, shareware) \$10
- Music**
- 186 Compose, edit & play music, w/doc \$5
- Passion**
- 190/191 Graphics, adults only (2 disks) \$10
- Utilities**
- 213 Best of Utilities \$5
- 244 30 useful disk & programming util. \$5
- 1 Yr. Membership: Quarterly magazines, special discounts, plus directory \$20

SPECIAL! Any 6 disks +
Only \$39.95 Apple Directory
(plus \$4 s/h) 1 Yr. Membership
(IIgs disks may be included)

Add \$4 (\$10 foreign) shipping and handling for disk orders, or \$2 (\$5 foreign) if ordering directory only. CA orders add sales tax.

Enclosed \$_____ by Check VISA MC

Card no. _____ Exp. _____

Name _____

Address _____

City _____ State _____ Zip _____

THE PUBLIC DOMAIN
EXCHANGE 2074C Walsh, Ste. 524
Santa Clara, CA 95050

CALL NOW: In CA 408-496-0624 DEALER INQUIRIES INVITED

ORDER TOLL FREE 800-331-8125

The MemorySaver board can best be thought of as an independently powered expansion bus for the memory-expansion slot on the Apple IIgs.

boot. After you have restarted your GS, you can load the files you want into /ROM, use the Control Panel to set the startup slot to ROM Disk, and turn your machine off and on again to boot from /ROM. Once you've installed the ROM disk and loaded the files you want, the ROM disk operates like any other disk drive on your system, only faster. If you configure it as your boot drive, some interesting things happen. The system maps /ROM into slot 5, drive 1, and shoves any other 3.5-inch drives down the line (see figure 3).

Memory Management

All the IIGS memory is allocated by the Memory Manager tool set. The MemorySaver software partitions the available RAM on the expansion card(s) by telling the Memory Manager which banks of memory are in use, thus preventing the overwriting of information on the ROM disk. With two memory-expansion cards installed, the MemorySaver divides the memory on each card into two four-megabyte segments. It then determines

the actual amount of memory installed on each card, maps that amount into the lower half of each four-megabyte bank, and informs the Memory Manager that the balance is in use, even though it is not there.

The manual gives a good explanation of how a ROM disk works and what precautions you should take during installation. Its photos and diagrams help with installation. The manual also contains a

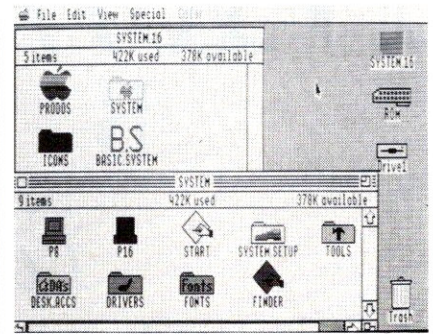

Figure 2: Screen shot showing what files to load from the system disk onto the ROM-disk volume so you can use the Finder as your program selector

troubleshooting section and a section on Checkmate's seven-year warranty and service policy. The appendix covers Squirt, a program selector that comes in the package. /ROM Problems

I had two problems when I was using /ROM as my startup device: remembering which slot my 3.5-inch drive was in and figuring out a way for my seven-year-old daughter to boot her games. I solved the first by using pathnames and the second by using the

MEMORY CARD	FRONT	BACK
ALS Add-RAM gs.....	■ ■
Apple gs Memory.....	■ ■	■.....
Applied Engineering gs-RAM.....	■ □
Applied Engineering gs-RAM Plus.....	■
Applied Ingenuity gs Juice.....	■ ■	■.....
AST RamStackPlus.....	■ ■
Checkmate Technology MultiRam gs.....	■	■.....
MDIdeas OctoRam.....	■ ■
Orange Micro RamPak4gs.....	■ ■
On Three ON-BOARD.....	■ ■
Parallax MegaRAM.....	■ ■
■ Yes		
■ ■ MemorySaver slot extender required.		
■ □ MemorySaver slot extender not required for Rev. A, B cards; required for Rev. C, D cards.		

Figure 1: A list of RAM cards that are compatible with the MemorySaver

Will Not Be UNDERSOLD!

AND WE MEAN IT!*

Prices Expire 5-31-88

Genuine IBM® Printer

8½" Letter Size • 80 Column
Limited Quantities

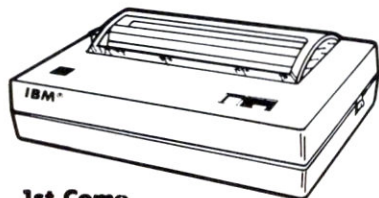

1st Come
1st Serve

5¼" DS-DD Disks
Sale **19¢** ea.*
List 49¢ ea.
Min. Qty. 50 - Max Qty. 250
Sleeves 2' Min. Qty. 50

Sale \$44.95

(Add \$7.50 shipping.*)

List \$199

- Unbelievable Low Price
- Underline
- Advanced Dot Matrix - Heat Transfer
- Enlarged
- Upper & Lower Case (With True Lower Descenders)
- Graphics With Commodore, & Apple Interfaces
- Ready to Hook Up To Serial Port Of IBM® PCjr
- Low Cost Adapters For IBM®, Apple, Commodore, & Laser Computers

22 CPS Daisy Wheel

13" Daisy Wheel Printer With
True Letter Quality



Sale \$99.95

(Add \$12.00 shipping.*)

List \$499

- Daisy Wheel Printing
- True Letter Quality
- 22 CPS, AAA Text
- Below Wholesale Cost
- 13" Wide Carriage
- Both Daisy Print Wheel & Ribbons Compatible with Diablo™ & Qume®
- Single Sheet or Continuous Feed
- Includes Interface for Apple IIGS, IIc & Laser 128

Ultra Hi-Speed Printer

300 CPS Draft • 50 CPS NLQ
With Color Printing Capabilities

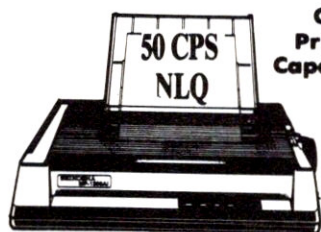

Color
Printing
Capabilities

*No One Sells
This Printer
For Less!*

Sale \$279.95

(Add \$10.00 shipping.*)

List \$499

- 300 CPS Draft - 50 CPS Near Letter Quality
- Front Panel Margin Setting
- Download Character Setting
- Epson/IBM Modes
- Variety Of Characters & Graphics
- Bottom Feed
- Parallel & Serial Interface Ports
- 10K Buffer
- Auto Paper Load & Ejection
- Optional 7-Color Printing Kit..... Sale \$99.95

Complete Apple® Compatible System

Computer, Drive, Monitor, Printer & Software

Sale Price
\$479.95

Sale



List \$1228 (Add \$35.00 shipping.*)

- Laser 128K Computer
- Video, Parallel & Serial Ports
- Runs Virtually All of the Apple II/IIc/IIe Software
- Hi Res 12" Monochrome Monitor
- Genuine IBM 8½" Printer With Interface And Heat Transfer Paper
- Software: Word Processor, Spreadsheet & Data Entry

*No One Sells
This System
For Less!*

Apple® is the registered trademark of Apple Computers Inc.

15 Day Home Trial • 90 Day Immediate Replacement Policy

COMPUTER DIRECT

22292 N. Pepper Rd, Barrington, IL. 60010

Call (312) 382-5050 To Order!

* Illinois residents add 6 1/4% sales tax. All orders must be in U.S. Dollars. We ship to all points in the U.S., CANADA, PUERTO RICO, & APO-FPO. Please call for charges outside continental U.S. or C.O.D. MAIL ORDERS enclose cashier check, money order, or personal check. Allow 14 days delivery, 2 to 7 days for phone orders and 1 day express mail. Prices and availability subject to change without notice. Shipping and handling charges are not refundable. (Monitors only shipped in continental U.S.) COMPUTER DIRECT will match any valid nationally advertised delivered price on the exact same product with a comparable payment method (excluding any applicable sales taxes). A physical copy order of the current valid lower priced ad must be supplied with the order, or within 15 days of date of purchase. **VISA — MASTERCARD — C.O.D.**

CIRCLE 265 ON READER SERVICE CARD

For APPLE IIGS

SYSTEM SAVER\$79, JUICEBOX \$49, Conserver \$119
 MDIDeas Superionic Stereo Card \$59, Digitizer add on\$ 49
 GRAPPLER GS/c..\$79, PROGRAPPLER ..\$89
 ADAPTOR to connect IIGS to two 20 pin DRIVES ...\$39
 GSRAM 256K..\$179, AST Vision Plus ..\$299
 MAGNAVOX RGB 13" Monitor for IIGS \$329
 CABLES: IIGS to Modem, Imagewriter, specify ...\$20ea
 (NEW SHOW OFF...\$45, LIST PLUS...\$69)

Deskworks \$49, Multiscribe \$79; Fontpak \$39
 DELUXE PAINT IIS\$69; Art Part V1, V2, Holiday\$25ea

GRAPHIC WRITER V2 (For Desktop Publishing)\$99

WORDPERFECT 2.0 w/Spell & Thesaurus \$99

Mavis Beacon TEACHES TYPING, IIGS \$39

PRINTSHOP..\$45; Add-on Disk Sampler#1\$29

FANTAVISION GS..\$45, School Version ..\$59

PAINTWORKS+ \$59, Add-on Disk Postcard \$25

WRITER'S Choice Elite \$59 TOP DRAW \$59

GRAPHIC STUDIO...\$49, DRAW PLUS ...\$59

Instant Music \$39, Add-on Hot & Cool Jazz \$29

MUSIC STUDIO...\$59, Music Constr Set ...\$39

MIDI Compatible Music Studio V2.....Call

MARBLE MADNESS..\$29, DREAM ZONE \$39

TOWER of MYRAGLEN, SEASTRIKE \$35ea

Basketball, Hardball, Shanghai, Silent Services\$35ea

Hacker II, Tasstimes, Talking Reader Rabbit\$39ea

New for GS (Math Rabbit\$35, Writer Rabbit\$35)

SpellerBee, Kidtalk, Mathtalk, FirstShapes \$35ea

Math Fractions \$35, First Letters & Words \$35

World Games, Winter Games, Space Quest ...\$39ea.

Destroyer\$29, LeisureSuit \$29, MonteCarlo \$39

ROADWAR 2000...\$39, Cavern Cobra ...\$35

Visualizer\$79, Softwood File\$79, Madlibs\$19

ORCA/M \$59, ORCA or TML Pascal ...\$99ea

For APPLE IIGS,e,c

EPIC Classic 2400B Internal Modem\$175

Practical 2400 B External Modem \$199

DATALINK Internal Modem IIGS,e \$179

MITSUBA 1200B External Modem\$129

Imagewriter Compatible Printer(No color) \$279

20 MB SIDER Hard Drive \$695, 40 MB \$995

128 K Internal Buffer for Imagewriter II.....\$79

64K 80 Col Card for IIe \$59, 256K Card\$119

RAMWORKS III 256K \$169, 256K Chips \$Call

SYSTEM SAVER for IIe/II+ Beige/Platinum \$69

KOALAPAD IIe \$89, Half Height Drive \$139

DRIVE CONTROLLER for 20 pin drives\$59

CH Mach III Joystick\$39, CH Flightstick \$59

4Way Joypot Selector \$39, ThunderScan\$199

HEAVY DUTY POWER SUPPLY IIe,II+ ..\$59

6 SCRIBE Ribbons \$30, 6 Multicolor for Image II \$60

6 Ribbons for Imagewriter \$30, Better Q...\$48

TIMEOUT Desktools, Filemaster, Sidespread \$35ea

TIMEOUT Graph\$59, Spell\$49, Font\$59, Macros\$39

Home Accountant Expanded Version for 128K IIe,c...\$49

CHUCK YEAGER's Flight Trainer IIGS,e,c \$35

CROSSWORD Magic \$35, PRINTSHOP \$35

WINGS of FURY \$29, Certificate Maker \$29

Where in world is Carmen SD \$29, Where in USA\$35

DB MASTER Version 5 \$149, Turbo Pascal \$45

Merlin Pro \$99, Assembly Lines (by RW) Disk+Book ...\$39

COPY II PLUS 8.1 \$29, LOCKSMITH6.0 \$45

(PUBLISH IT! Desktop Publishing IIGS,e,c.\$79)

PRINTRIX \$49, PRINT-QUICK \$39, Fontdisks Call

Universal File Conversion (DOS,ProDOS,Pascal)..\$34

APPLEWORKS MADE EASY BOOK.....\$19

Circle Reader Service Card for a Catalog.

(This A+/Nibble May 88 AD was Mailed in Feb 88.)

SCHOOL PURCHASE ORDERS WELCOME

NOTE 1: Shipping \$3/100 in Continental USA. Others Call.

NOTE 2: We do not guarantee product compatibility.

NOTE 3: Prices & Descriptions subject to change any time.

NOTE 4: Returns without Pre-Authorization not accepted.

NOTE 5: Written Return Request must be made within 10 days of receipt. We shall replace or issue credit at our option.



COMPUTERS PLUS COMPANY
 2303 N. 44th Street #2, PHOENIX AZ 85008
PHONE:602-955-1404

CIRCLE 312 ON READER SERVICE CARD

STARTUP SLOT = 5

Drive	Location
1st Apple 3.5 Drive	S5, D1
/RAM5	S5, D2
2nd Apple 3.5 Drive	S2, D1
1st UniDisk 3.5	S2, D2
1st UniDisk 5.25	S6, D1
2nd UniDisk 5.25.....	S6, D2

(RAM disk active)

STARTUP SLOT = ROM DISK

Drive	Location
/ROM.....	S5, D1
1st Apple 3.5 Drive	S5, D2
2nd Apple 3.5 Drive	S2, D1
1st UniDisk 3.5	S2, D2
1st UniDisk 5.25	S6, D1
2nd UniDisk 5.25.....	S6, D2

(RAM disk inactive)

Figure 3: List of the slot and drive assignments when you're using a 3.5-inch drive in slot 5 as your startup drive or the ROM disk as your startup drive

```

2 HOME
5 VTAB 12
10 INPUT "TYPE THE DRIVE NUMBER YOUR DISK IS IN ";A
20 IF A = 1 THEN PRINT CHR$(4) "PR#6" : REM BOOTS FIRST 5.25-INCH DISK
30 IF A = 2 THEN PRINT CHR$(4) "--PRODOS,S5,D2" :
   REM BOOTS FIRST 3.5-INCH DISK
40 IF A = 3 THEN PRINT : GOTO 10 : REM ASKS AGAIN
50 IF A = 4 THEN PRINT : GOTO 10 : REM ASKS AGAIN
60 IF A = 5 THEN PRINT CHR$(4) "-GO.16" : REM BOOTS FINDER ON ROM DISK
70 IF A = 6 THEN PRINT : GOTO 10 : REM ASKS AGAIN
80 IF A = 7 THEN PRINT : GOTO 10 : REM ASKS AGAIN
90 IF A = 8 THEN PRINT : GOTO 10 : REM ASKS AGAIN
100 IF A = 9 THEN PRINT : GOTO 10 : REM ASKS AGAIN
110 IF A = 0 THEN PRINT : GOTO 10 : REM ASKS AGAIN
  
```

Figure 4: A BASIC program for MemorySaver users that allows you to bypass the Finder and boot games without resetting the startup slot

BASIC program in figure 4. This program allows her to boot her games without going into the Control Panel to reset the startup slot and also lets me bypass the Finder. The memory overhead for ProDOS 8, Basic System, and the BASIC program called Startup is 27K. I gave the system-disk application named ProDOS a new name, GO.16, so it would not conflict with ProDOS 8. Hopefully Apple will allow direct booting of slot-6 drives in a future release of the Finder.

I called Checkmate's toll-free number, got right through to a technician, and asked him several questions. The technician's answers were clear and to the point. I told him that my battery cable had come loose from the mounting plate. He said that the company had corrected that problem and that he would send a replacement. Five days later, I received it and sent the old one back.

Should You Buy One?

The MemorySaver is ideal for those who don't like wasting time while booting the GS. The alternative is to set up a big RAM disk and never

turn off your GS; in such a situation, however, you would lose everything in the event of a power failure and would be restricted to using one memory-expansion card only. The adaptability of the MemorySaver makes it a more attractive alternative. +

Laerie Easterly is a certified Apple developer, free-lance writer, and president of the Apple Portland Program Library Exchange users' group in Portland, Oregon.

VITAL STATISTICS

MEMORYSAVER

The MemorySaver board is an independently powered memory-expansion bus with battery backup. It fits into the memory-expansion slot, holds two memory boards, and can handle up to eight megabytes of RAM. It comes with software that allows the creation of a high-speed ROM disk from a portion of the RAM.

CPU: Apple IIgs

DISK DRIVES: one 3.5-inch

OPERATING SYSTEM: ProDOS

LIST PRICE: \$149.95; slot-extender board, \$39.95

Checkmate Technology, Inc.
 509 South Rockford Drive
 Tempe, AZ 85281
 (602) 966-5802

CIRCLE READER SERVICE NO. 355

The Memory Saver Tips

The following suggestions should help you use your MemorySaver board to its fullest advantage.

1. Use only rechargeable batteries.
2. Do not forget to install the insulating paper between the side of the IIGS case and the back of your memory card.
3. Use only "CAS before RAS" memory chips on your memory cards. The MemorySaver package includes a list of acceptable chips.
4. Checkmate does not recommend the use of a RAM disk while a ROM disk is active. You can have conflicts between the memory dedicated to the ROM disk and the memory for the RAM disk. I have run into such a problem only when copying large amounts of data to the RAM disk. Small amounts, 5 to 10K, seem to work all right. The worst experiences I've had while copying large files were getting an I/O Error message and having files not copy onto the ROM disk.
5. When you're using two memory boards, dedicate all the memory on one board to serving as the ROM disk and leave the memory on the other card available for program use.
6. Be sure that you plug the wall transformer into a nonswitched wall outlet to prevent the loss of the ROM disk.
7. If you have a card in slot 7, be sure to get the MemorySaver Extender to prevent the memory card attached to the front side of the MemorySaver board from touching the card in slot 7.
8. You cannot use memory boards that use different-size chips. For example, if the back card uses 256K chips, the front card must also use 256K chips, rather than one-mega-byte chips.
9. Fonts and desk accessories can take up a lot of disk space.
10. To increase the speed of launching applications from the Finder, turn off the Save Finder Information Onto Disk option on the Preferences menu.

You Could Be Online In The Time It Takes To Read This Ad.

Point-to-Point is quick and simple to learn and use. It's also powerful and complete. In every respect.

And because you can be online in the time it takes to read this ad, Point-to-Point is also the #1 communications program among Apple II computer users.

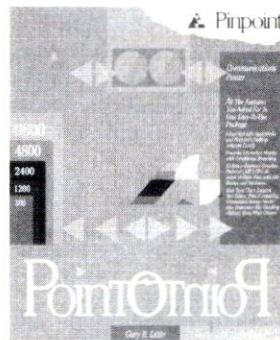

Pinpoint Publishing • 5865 Doyle St. #112 • Emeryville, CA 94608 (415) 654-3050
©1987 Pinpoint Publishing. Pinpoint and Point-to-Point are trademarks of Pinpoint Publishing.

You Can Keep Track Of Everything In No Time At All.

ProFILER is the new Apple II database manager you can use with or without a mouse. So its big features make small demands on you. Now, when you're just getting started. And in the future, when you're an expert.

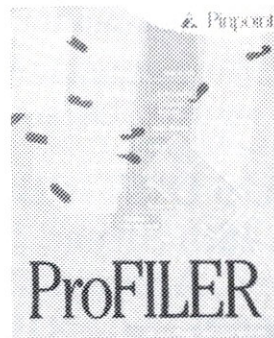

Built-in macros, B-tree indexes, fantastic reports, and fields as big as a screen, or as small as just one character, help you can keep track of everything in no time at all.



Pinpoint Publishing • 5865 Doyle St. #112 • Emeryville, CA 94608 (415) 654-3050
©1987 Pinpoint Publishing. Pinpoint and ProFILER are trademarks of Pinpoint Publishing and Custom Computer Products.

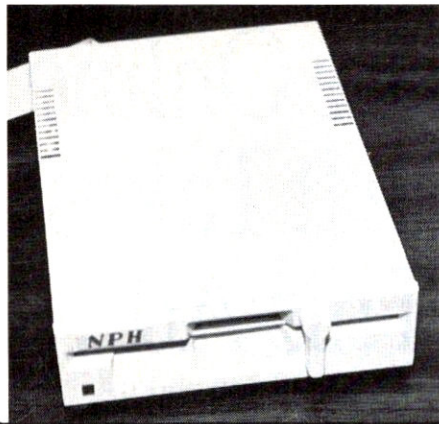

5 1/4" DISK DRIVES FOR APPLE

1 Year Warranty
Parts & Labor
100% Compatible
Super Quiet
Adjustable Speed
Control

Apple II, II+, IIe
Franklin Ace 1000

\$79.00

Apple IIc, IIGS
Apple IIe UniDisk
Laser 128

\$79.00

Shipping & Handling \$5.00

We have the **ABSOLUTE** Lowest Prices
on
CHECKMATE PRODUCTS

- MultiRam IIe 64K \$109.00
- MultiRam IIe 256K \$129.00
- MultiRam IIe 512K \$179.00
- MultiRam IIe 768K \$229.00
- MultiRam RGB 64K \$139.00
- MultiRam RGB 256K \$169.00
- MultiRam RGB 512K \$219.00
- MultiRam RGB 1 Mb \$319.00
- MultiRam Plus ALL K Call
- Q Card 64K \$75.00
- Q Card 256K \$99.00
- MultiRam CX 256K \$130.00
- MultiRam CX 512K \$179.00
- MultiRam CX+ 512K \$182.50
- MultiRam GS Call
- Pro Term \$74.95

**ALL NEW
GS MEMORY SAVER
\$109.00**

- Extended 80 Column Card
For Apple II
\$40.00
100% Appleworks Compatible
5 Year Warranty
- Super Serial Card
100% Apple Compatible
5 Year Warranty **\$59.00**
- Graphics Printer Card w/Cable
For Apple II+ & IIe
5 Year Warranty \$49.00
- 64K Buffered
Graphics Printer Card w/Cable
For Apple II+ & IIe
5 Year Warranty **\$85.00**
- 16K Card for Apple II+
5 Year Warranty \$35.00
- 128K Card For Apple II+
5 Year Warranty **\$85.00**
- 80 Column Card For Apple II+
\$49.00 5 Year Warranty

- Super Expander IIe
1 Mb Board with Software
256K — \$99.00
512K — \$134.00
1 Year Warranty
- Super Expander GS
256K — \$99.00
512K — \$134.00
1 Year Warranty
- Disk Controller Card
For Apple II, II+ & IIe
5 Year Warranty **\$39.00**
- CPM Card for Apple II+ & IIe
5 Year Warranty \$39.00
- Cooling Fan For Apple II+ & IIe
With Surge Suppressor **\$29.95**
- Cooling Fan For Apple IIGS
\$24.95 No Noise Interference
- Numeric Keypad
For Apple IIe
\$34.95
- Joystick For Apple IIe, IIc, & IIGS
With Fire Button Same as Mach III **\$25.00**

Replacement Keyboard

\$55.00
For Apple IIe

5 Amp
Power
Supply

\$49.00

For
Apple II
II+ & IIe

We Ship Federal Express



Continental U.S. Only

Prices subject to change without notice

RF Modulator

For
Apple II+ & IIe

\$19.95

VISA & MASTERCARD — NO EXTRA CHARGE DEALER PRICING
+\$4.00 for Shipping - C.O.D. + \$2.50

MEMORY PLUS DISTRIBUTORS, INC.

We carry only the
Highest Quality products for
your Apple.
That's why we are
the LARGEST
and
the BEST!

505 South 48th Street, Suite #104

Tempe, Arizona 85281

(602) 820-8819

(602) 830-6457

Serving Apple Users Since 1983

10 a.m. to 5 p.m.

M.S.T.

Mon - Fri.

University & School P.O.
Accepted

20% Restocking charge
on returned items

A+ APPLEWORKS REPORT

In this second of a three-part series on the AppleWorks universe of products, we focus on education.

FEATURE REPORT

BY DAVID E. CHESEBROUGH

APPLEWORKS EDUCATIONAL RESOURCES MAKE THE GRADE

AppleWorks isn't just for homes and small businesses. It also is one of the best choices for schools in achieving computer literacy and classroom integration and serving as a teaching/administrative tool. In fact, the number of support products for educational applications of AppleWorks has recently exploded.

You, as a teacher, librarian, or administrator can surround yourself with a host of useful resources designed to help you get more mileage out of AppleWorks.

RESOURCE BOOKS

Books about AppleWorks for educators range from introductory to advanced and cover educators' as well as students' needs.

AppleWorks for Educators: A Beginner's Workbook

This manual by Linda Rathje is useful for conducting AppleWorks in-service workshops. Rathje has taken lessons she's developed over the years and combined them with relevant reprints from *The Computing Teacher*. The materials come with a data disk and, although they

are not comprehensive, offer a good start for teachers. (\$18; shipping, \$2.50; billing, \$2.50)

AppleWorks for School Librarians

This introductory manual by May Lien Ho is best suited for novice librarians who can learn basic skills while seeing how AppleWorks can apply to library operations. The template disk offers many simple examples of relevant AppleWorks applications. (\$29.95)

AppleWorks for Teachers

This well-organized and -conceived book/disk combination by Patti D. Nogales and Carol H. McAllister leads educators through AppleWorks by having them accomplish typical tasks: writing letters and memos, creating seating charts and student databases, and analyzing grades. Nogales and McAllister have produced one of the best educationally focused AppleWorks books, although it lacks coverage of integration and mail-merge functions. (\$16.95 [includes disk])

Computing Tools: AppleWorks

This package is designed for

teaching AppleWorks in grades 9 and above, as well as training teachers in introductory skills. (\$55)

STUDENT TEXTBOOKS

AppleWorks in Your Classroom: A Student Introduction

I developed the activities in this book while establishing a model program for integrating AppleWorks into a school curriculum. The lessons are self-paced, interactive, and built around student application examples on the copyable resource disk. (\$6.95; ten books with Resource Disk, \$99.95)

ClassWorks: AppleWorks for the Classroom

ClassWorks is a comprehensive set of instructional materials designed to introduce AppleWorks to students or teachers. In addition to explicit text-based lessons on the three AppleWorks programs, the package includes a data disk, command reference sheets, quizzes and answer keys, and overhead-transparency masters. The purchase price includes a site license for one school building. (\$39.95)

Developing and Using Office Applications with AppleWorks, Versions 1.0-2.0

This comprehensive text by M. S. Varnon teaches business applications as students work through activities to learn skills applicable to the various AppleWorks components, including mail-merge. Each unit concludes with a challenge that uses the skills learned in the unit activities. An instructors' manual, transparency masters, and resource disk are free with the purchase of 20 texts. (\$18.50)

Hands-On AppleWorks

This three-text series, each one devoted to one of the AppleWorks modules, is by Arthur Luehrmann and Herbert Peckham. Each soft-cover student workbook offers a general introductory section, lessons for the specific application, and lessons to reinforce and expand learning. A teacher pack (guide, reproducible masters, copyable data disk, and student set) is free when you purchase 20 texts. You can also purchase a wall chart

of AppleWorks commands. (\$9.25 each; three-text set, \$18.95; wall chart, \$14.95)

Understanding and Using AppleWorks

This textbook by Frank Short offers three sections—"Getting Started, Mastering, and Advanced Applications"—for each AppleWorks module, plus guidance on integration. Many of the applications are relevant to school or student use. If you purchase 20 books, you also get an instructors' manual, transparency masters, and a copyable resource disk for free. (\$16.50)

Using AppleWorks in the Classroom

This 350-page sourcebook by Joan Postman and Jennebeth Bogard is for teachers who want to present AppleWorks in a step-by-step fashion to a whole class. It offers detailed lessons, student worksheets, overhead-transparency masters, and an activity disk, covering all the AppleWorks components in an introductory fashion. (\$85.60; school price, \$60)

TEMPLATES

Templates are AppleWorks files that set up the program for a specific application, such as recording grades. Many education-related templates are available.

Customized Gradebooks

With information you provide to template publisher Jim Crawford about your particular grading system and number of students and classes, Crawford customizes the grading templates he has devised to suit your needs. Instructions and spreadsheet protection make this product especially useful for novice AppleWorks users. (\$21.95)

GradeWorks

Program author Jeffrey Bernier has assembled nine good-quality grading templates that offer several grading options, and a utility program to help grade and scale tests. Strong documentation guides you through the use and modification of the templates. Bernier even offers to help modify any of the templates for novice users free of charge. (\$29.95)

5 1/4" APPLE® II DISK DRIVE



TOLL FREE PHONE NO.
FOR ORDER ONLY.
1-800-433-6224 (OUTSIDE CA)
1-800-553-6224 (INSIDE CA)

**ONLY!
\$77!**

MEIJI

One Year Warranty

**UniDisk Port Option
at \$23.00**

- Fully Apple® II Series Compatible
- Laser 128 Compatible
- Speed Adjustable
- 164K Formatted Capacity
- Brushless Direct Drive Motor
- Extreme Quiet Operation
- Gate Array IC Design
- 48 Hrs Factory Burnt-in Tested
- Ultra-high Precision Head Positioning and Loading



No COD Order
Accept School's P.O

SEND MONEY ORDER OR CHECK TO:
KINSON PRODUCTS CORP.

260 S. LOS ROBLES #107
PASADENA, CA 91101

For inquiry please call (818) 792-8953

FAX (818)792-1162

Apple® IIc/IIgs Cable Installed — \$7 extra.
Shipping: Add \$5.00 per drive (UPS Ground)
CA Resident Please add 6.5% sales tax.

Apple is a trademark of Apple Computer

Terms: 15% restocking fee on non-defective goods. No return w/o RMA #. No refund on shipping.

CIRCLE 187 ON READER SERVICE CARD

To boldly go at speeds no man has gone before.

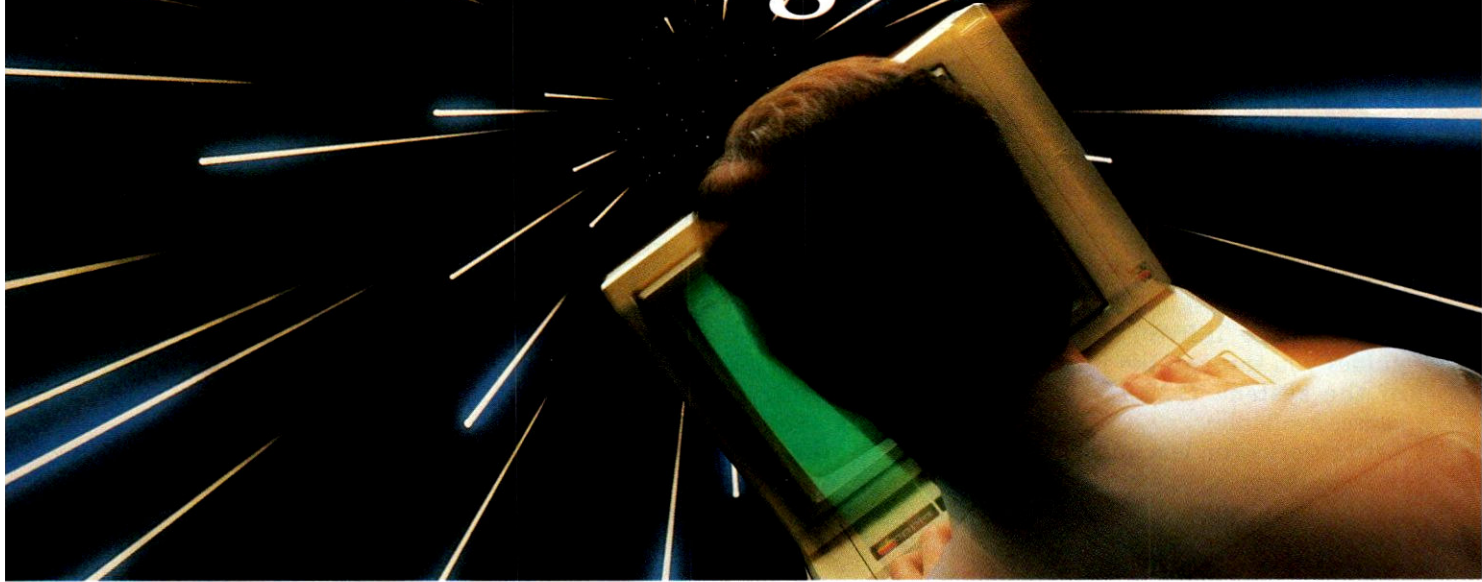

Make your Iie or II + 40% faster than the IIGs! The TransWarp Accelerator: A Proven Product. Available now!

Computing at warp speed!

It's an experience you shouldn't miss. And with TransWarp, you won't have to. Because TransWarp will run your Iie or II + software *3.6 times faster* — that's 40% faster than Apple's IIGs!

No more yawning while your Apple slowly rearranges text or calculates spreadsheets. With 256K of ultra-fast RAM, TransWarp speeds up *all* Apple software — including AppleWorks, and all educational software, graphics and games. And it's compatible with all standard peripheral cards (such as RamWorks and Apple memory cards), hard disks, 3½" UniDisks, 80-column cards, modems, clock cards, mice and more! You name it, TransWarp accelerates it. There's even a 16 bit upgrade chip available.

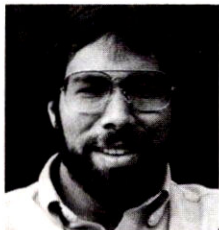

"TransWarp is great! I have replaced all my other accelerators with it!"

*Steve Wozniak, the creator
of Apple Computer*

An important difference.

With TransWarp, software runs up to three times faster than with other cards, since the others can't accelerate programs in auxiliary memory. That's why TransWarp is so much faster than the rest. Nearly all of today's more powerful programs run partially or completely in auxiliary memory: programs like AppleWorks, Pinpoint, Managing Your Money, SuperCalc 3a, BPI and Pascal, to name a few. Why settle for a card that accelerates only part of the memory?

There's one more important difference. Since TransWarp doesn't use memory caching, you get *consistent* high speed performance.

A cinch to use.

Simply plug TransWarp into any slot in your Apple II, II + or Iie — including slot 3 in the Iie. Instantly you'll be computing

at speeds you only dreamed about before. And should you ever wish to run at normal speed, simply press the ESC key while turning your Apple on.

Since TransWarp is completely transparent, you won't need preboot disks or special software. It's ready to go right out of the package!

Speed = Productivity

Imagine the productivity gains you'll achieve when your programs are running over three times faster. TransWarp is so powerful, your Apple will make IBM PCs and even ATs look like slowpokes.

- 3.6 MHz 65C02
- 256K of ultra-fast on-board RAM
- Accelerates main *and* auxiliary memory
- Low power consumption for cool operation
- Totally transparent operation with all software
- Plugs into any slot, including slot 3 on the Apple Iie
- Accelerated 16 bit option available
- 5-year warranty

Satisfaction guaranteed!

Give *your* Apple the TransWarp advantage. With our risk-free 15-day money back guarantee, you have nothing to lose but wasted time. Call today!

TransWarp accelerator \$219
65C802 16 bit upgrade (may add later) \$69

For fast response:

See your dealer now. Or *call* Applied Engineering, 9 a.m. to 11 p.m., 7 days at (214) 241-6060. MasterCard, VISA and C.O.D. welcome. Texas residents add 7% sales tax. Add \$10.00 if outside U.S.A. Or *mail* check or money order to Applied Engineering, P.O. Box 798, Carrollton, TX 75006. Prices subject to change without notice.

AE Applied Engineering

The Apple enhancement experts.

P.O. Box 798, Carrollton, TX 75006 (214) 241-6060

TransWarp is a trademark of Applied Engineering. Other brands and trademarks are registered trademarks of their respective holders.

IEPWorks

If you write IEPs (individual educational programs), you should be excited about the potential of this authoring system. This product includes data files of goals and objectives in addition to Super MacroWorks and UltraMacros (from Beagle Bros) macros that automate much of the process of generating an IEP. (The macros require you to have one of these programs and—with UltraMacros—AppleWorks version 2.0 as well.) The 33-page IEPWorks manual guides you through the intricacies of the system. (\$29.95—site licenses available)

LetterWorks for Teachers

Techniform has created a number of useful form letters, such as letters to publishers, parents, government agencies, and educational companies, in addition to resumé forms. (\$39.95; shipping and handling, \$2)

Principals' Pal and Teachers Aide series

This set includes four disks for

education: Band Aide, Teachers with Class, Guys in Vocation, and The Meal Planner. Each disk has a collection of files with simple directions and is best suited for novice users who can use ideas for AppleWorks applications. (\$22.50 each; set of four, \$80)

School Zipfiles

The spreadsheet templates on this disk are the best-designed I have ever seen. The main files contain extensive grading spreadsheets, a spreadsheet for adding trigonometric functions to AppleWorks, and a self-scoring test. You receive extensive on-disk documentation. (\$24.95)

SchoolWorks

SchoolWorks comprises templates with documentation and prepared database-report formats on three double-sided disks—SchoolWorks: Teacher, SchoolWorks: Office, and SchoolWorks: Athletic Director. The spreadsheet files offer useful features and examples. (one disk, \$55; two, \$99; three, \$125)

Special Education Student Information Database

This product comes with just a single database template, but the 15-page loose-leaf manual guides beginners in maintaining a special-education database. (\$10)

SportsWorks

This series of 14 template disks is for the record keeping that comes with athletic coaching or administrative positions. The disks include Athletic Director, Club/League Organizer, Baseball, Football, Soccer, Softball, Swimming & Diving, Track & Field, Volleyball, Tennis, and Wrestling. (\$35 each)

Teachers Tools

The main offerings of this disk are the grading templates. The key one requires at least 256K of RAM, but it offers you the largest collection of features I have ever seen in a grade template. Other files include macros for SuperMacroWorks, AutoWorks, or Key Player to automate use of the grade template, as well as a few correspondence and database files. (\$29.95)

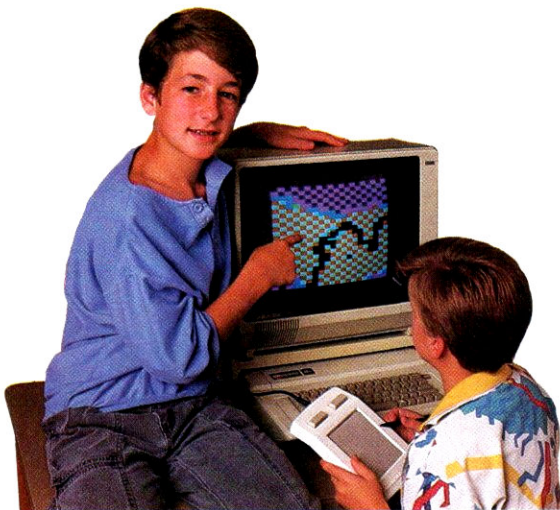

KoalaPad+. The low-cost drawing pad for the Apple II family of computers. Suggested Retail Price \$139.50. Ask for it at a computer store near you.

Creativity Runs In The Family. . .
and the KoalaPad+™ keeps it running.

Using the KoalaPad+ to create drawings on your computer screen is just like working with pen and paper. Students and their parents are discovering how easy it is to express themselves in a variety of creative ways by combining the KoalaPad+ tablet with all the best Apple II graphics programs. The excitement and rewards of learning are immediate. You can instantly interact with the computer and it all happens with the touch of a finger or stylus.



Koala Technologies / A Pentron Company

269 Mt. Hermon Road • Scotts Valley, CA 95066-4029 • (408) 438-0946 • Telex 17684 • FAX (408) 438-0967

KoalaPad+ is a trademark of Koala Technologies. Apple II is a trademark of Apple Computer, Inc. Copyright © 1987 Koala Technologies.

CIRCLE 176 ON READER SERVICE CARD

HOT. MEAN. RADIO- ACTIVE.

AUGUST 20, 2087

Nothing could be worse than this god-forsaken, radioactive desert.

More Sniperdroids! All tracking me with them death glares. And them Uzis. They're weird trigger-twitchin' folks. I suspect it's them poisoning the water.

Or maybe it's those Leather Thugs. Heck, I don't know anymore. I heard they have a bunch of civilians cut off east of Ranger Center, which is where I'm headed. Hope not. They want me dead. Like every other mutant this side of Vegas.

The worst part is, I'm getting to be as bad as they are. You wouldn't believe some of the ways I've learned to kill. I hang out in sewers, and my best friend is a MAC 17 submachine gun.

Gramps talked about life before the nuclear war. All I know is I don't want others living this way. Gotta rebuild this desert right. Gotta make it so you can sleep with your eyes closed.

WASTELAND™ A new role-playing game from the creators of the Bard's Tale™ series.



3 WAYS TO ORDER: 1) Visit your retailer. 2) Call 800-245-4525 from U.S. or Canada, 8am to 5pm PST to order by VISA/MC. 3) Mail check (U.S.\$) or VISA/MC #, cardholder name, and exp. date to Electronic Arts Direct Sales, P.O. Box 7530, San Mateo, CA 94403. Apple II version \$49.95, plus \$3 shipping/handling. CA residents add 6.5% sales tax. Allow 1-3 weeks for U.S. delivery.

CIRCLE 103 ON READER SERVICE CARD



Apple II is a registered trademark of Apple Computer, Inc.

Write On!

Write On! is an extensive AppleWorks template library that uses word-processing functions to develop writing skills in grades K-12. The template disks are organized into five separate collections: Primary (\$1174), Upper Elementary (\$781), Intermediate (\$781), Secondary (\$560), and Special Education/ESL (\$560). You can also buy disk titles individually for \$59 (multiple-site licenses are available).

RESOURCE-FILE COLLECTIONS

These database and spreadsheet files come ready-made, filled with information on specific subjects. Teachers and students use this data to meet curricular objectives.

CareerWorks

CareerWorks is a unique offering that features extensive database files with information on 227 occupations for use in selecting potential careers. You can use these materials with individual students

or through school guidance counselors. (\$49.95 per disk; set of six, \$149; site license available)

Climate and Weather

Scholastic's strength has always been in the teacher-support materials, as is the case here. Each module offers experiments, teacher notes, activities, and AppleWorks instructional materials to help students use database and spreadsheet files to explore concepts. (\$59.95)

Computer Activities for the Classroom - Dinosaur Packet

I prefer classroom-developed and -tested materials such as this, which has been used with fourth-, fifth-, and sixth-graders studying dinosaurs. The written activities and data disk of word-processing, database, and spreadsheet files promote critical-thinking skills. (\$25)

Databases in the Classroom: AppleWorks Sampler

This collection of databases and support material are a good way to begin integrating AppleWorks into your classroom. Although the files (covering science, social studies,

and humanities) are not extensive, the teacher notes and student activities make the package useful. (\$45)

FactWorks
FactWorks is a four-volume series of resource files. The files are more like almanac listings than providers of the in-depth "encyclopedia power" that their maker advertises. Topics include science, grammar, sports, geography, and history. (\$32.95 per volume)

HelpWorks

This 340-page resource is the most comprehensive tutorial/teaching aid I've seen, with 120+ sample files and templates. The three-ring binder contains sections on all three AppleWorks components, in addition to disk management, spreadsheet design, and integration within AppleWorks. I'm most impressed with the question-and-answer databases and "learning files," which illustrate spreadsheet functions. (\$49.95)

Mindscape's Educational Division Software Catalog-on-a-Disk
Mindscape's free Catalog-on-a-

NEW FOR APPLE //GS

**Diversi-Key™
Keyboard Macro Program**

Boot **Diversi-Key** once at power-on, and add macro control to **ALL** your programs! One macro keystroke can type in thousands of pre-programmed keys for you. Call up to 100,000 macros in 320K memory! Define, edit, display, load, or save your macros at any time. Powerful programming options include nested macro calls, repeat, if/while, counter macro, time/date, and keyboard input.

Add mouse control to any program! Each mouse movement triggers one of 10 user-defined mouse macros.

Works with ProDOS, Pascal 1.3, DOS 3.3. Full set of Appleworks macros included.

Includes **FREE Diversi-Hack™**, a programmer's dream! Lets you enter the monitor any time, then return to your program.

For Apple //gs with 512K minimum . . . \$45

Diversi-COPY™

Fast 3.5 & 5.25 Back-up

Now you can copy or mass-produce unprotected 3.5 or 5.25 disks at maximum speed. Uses up to 800K memory in the //gs, //e aux. slot RAM card, or Apple RAM card for 1-drive, 1-pass copying.

"It's indispensable" - inCider magazine Editors' Choice for Jan. 1987.

For Apple //gs, //c, //e, //l+ \$30

**Diversi-CACHE™
Apple Disk 3.5 Speed-up**

Diversi-Cache brings your new Apple Disk 3.5 up to Ramdisk speed, without Ramdisk hassle. Just boot **Diversi-Cache** once at power-on, and watch your Disk 3.5 programs run up to 5 times faster! Works with ProDOS, Pascal 1.3, DOS 3.3.

Boot times for Apple //gs System Disk	
Without Diversi-CACHE . . .	41.0 sec
With Diversi-CACHE	19.2 sec
Reboot With	
Diversi-CACHE	9.6 sec

Speeds up "dumb" 3.5 drive only. For Apple //gs with 512K minimum \$35
Includes **FREE Diversi-HACK**

- Also from DSR (For //gs, //e, //c, //l+)
- Diversi-DOS™** \$30
Top-rated DOS 3.3 Enhancement.
- Diversi-DIAL™** \$475
7-line BBS/Chat Demo \$5

24-Hour Toll-Free Ordering
800 835-2246 ext. 127 (orders only).
For information call 313 553-9460.

Sold by mail-order only. Price includes 1st-class or foreign airmail. Return within 30 days for full refund if not fully satisfied. Visa/Mastercard (with exp. date). Check. Purchase orders accepted.

Diversified Software Research, Inc.
34880 Bunker Hill
Farmington, MI 48018-2728 

**FCC APPROVED TechCraft
5 1/4" APPLE II[®]
DISK DRIVE**



Model FD-103C: Ilc. Ilgs & Compatible \$85.00
Dual Disk Controller Card \$29.00

- Model FD-103**
- 100% Compatible with APPLE II, II+ & IIe
 - Direct Drive with Adjustable Speed Control
 - Gate-Array IC Circuit
 - 164K Formatted Capacity
 - Quiet High-Precision R/W Head



DATA TRANSFER SWITCH

- All Models For APPLE II Series, Mac & MacPlus
- Maximum Shielding Protection
- Hi-Tech Styling
- Heavy Gauge Steel Case

\$35
2-Way/AB Model

4-Way/ABCD Model \$45.00

ACCESSORIES

- Serial/Parallel Signal Converter \$75.00
- Surge Protection Power Strip (6 Outlets) \$12.50
- Modem, Printer & Peripheral Cables \$15.00
- RS232 Gender Changer \$ 7.00
- Centronics Gender Changer \$ 9.95
- RS232 Data Line Surge Protector, Mini Tester, Jumper Box . . . \$ 9.95
- Add \$5 For Shipping & Handling Charge.

MAXIMA ELECTRONICS INC.
P.O. Box 53548
Philadelphia, PA 19107

(215) 568-3711

Toll Free (Outside PA)
(800) 2-MAXIMA



Check or Money Order

APPLE & LASER are registered trade mark of their respective Companies

Disk contains information about its educational-software titles.

NewsWorks I/II/III

The NewsWorks series from the Newsweek Education Division offers a collection of AppleWorks database files (three per series), including a teachers' guide with lesson plans and student activity sheets. (NewsWorks I and II, \$29.95 each if your class subscribes to Newsweek Social Studies or Economic Programs; NewsWorks III, free with a class subscription)

Spreadsheets for Mathematics & Science: AppleWorks Sampler

This sampler of 22 spreadsheet files provides much-needed examples of how to use AppleWorks spreadsheets effectively with students. Teacher notes and student activities explain how to use the files, which are divided into grade 6-9 and 9-12 applications. (\$55)

The Constitution Then and Now

Students use AppleWorks files, as well as outside resources, to play roles in each of the two units in this package: The Constitutional Con-

vention and Bill of Rights. The teachers' guide, activities, instructional modules, and database and word-processing files promote inquiry, higher-order thinking, and group participation. (\$59.95)

The Power of Nation States

The teachers who developed these materials have assembled the most comprehensive collection of lessons and resource materials yet compiled on a topic. All materials, including activities, are files on the three disks, allowing you to alter lessons as you choose. Every high-school or college instructor of Global Studies or World Geography should take note of these materials. (\$95 site license)

VIDEOTAPES

One way to learn AppleWorks is by watching a videotaped lesson.

AppleWorks Video: The First Step

To me, this video offers the most sensible approach to integrating videotapes with AppleWorks instruction. The 35-minute VHS-for-

mat tutorial provides an overview of AppleWorks, through several presentations, including a simulated "real life" sequence of tasks for a PTA leader. Showing this video early on during an in-service course would help you present an overall view of AppleWorks. (\$39.99; shipping, \$3)

How to Use AppleWorks Video

This 90-minute training video covers the AppleWorks word-processing, spreadsheet, and database modules. It also includes instruction on commands, integration, and mail-merge (version 2.0 only). VHS and Beta formats are available. (\$39.95)

Videoware

Each of the five videotapes in this series covers a separate aspect of AppleWorks: Overview, Word Processing, Databases, Spreadsheets, and Troubleshooting. The written materials offer overhead transparencies and a script for an instructor. (complete package of five videotapes, \$199.95; individual prices are available)

PROGRAMMER

Applied Engineering is seeking an experienced 6502 and 65816 machine language programmer. 2 years minimum programming experience is required. We offer an exciting opportunity for the experienced programmer to take his skills to the limit. Applied Engineering offers an excellent compensation package including paid vacations, 11 paid holidays per year, health insurance program and more.

Applied Engineering's location in the suburbs of north Dallas offers a "buyer's market" for housing, as well as excellent schools, shopping and entertainment.

Successful applicant should have heavy machine language experience on the Apple IIe and IIGS as well as familiarity with AppleWorks. We're the best at what we do; if you are too, please send your resume to:

Applied Engineering
 P.O. Box 5100
 Carrollton, TX 75011
 Attn: Personnel

WANTED

For Super Savings,
Check Out our
New Monthly Specials

APPLIED ENGINEERING and the rest of the best ...always for less and in stock!

APPLIED ENGINEERING

(additional AE items in stock)

- GS-RAM, 256K
\$163
- Z-RAM Ultra 1, 256K
\$163
- Z-RAM Ultra 2, 256K
\$214
- Z-RAM Ultra 3, 256K
\$275
- GS-RAM PLUS, 1 Meg
\$526
- RamFactor, 256K
\$198
- RamWorks III, 256K
\$164
- RWIII, Expander, 1 Meg
\$561
- Serial Pro
\$119
- RamCharger for RamFactor
\$137
- Transwrap
\$169
- PC Transporter 768K
\$579
- Phasor
\$135
- ViewMaster 80
\$116
- DataLink
\$169

PORTABLE SYSTEM

- Prairie Pwr System, Battery
Pack (8 Hr, UPS) & Case
\$139
- C-VUE LCD Flat Monitor
\$349
- Cigarette Lighter Adptr
\$25
- World Port 1200 Modem
\$169

MAY SPECIAL

CMS 60 Meg
(SD)
(/e, GS)

Regularly \$1195

NOW \$900

SOFTWARE

(Sorry, no software refunds)

- AppleWorks 1.3
Special Version
\$119
- Locksmith 6.0 (Reduced!)
\$49
- Copy II Plus
\$35
- Bag of Tricks
\$44
- Beagle Brothers
Timeout Series
▶ **Call**
- PINPOINT:
StarterPak
\$99
- Desktop Accessories
\$63
- Spelling Checker
\$49
- Key Player
\$37
- Graphics Edge
\$69

Call for Our
Current Prices

HARDWARE

- Diconix 150 Printer
\$399
- //e Enhancement Kit
\$62
- Numeric Keypad (/e)
\$69
- //c System Clock (external)
\$55
- G STEREO (GS) (A.I.)
\$49
- CMS 20 Meg (SD) (/e, GS)
\$650
- CMS 43 Meg (SD) (/e, GS)
\$825
- Kensington GS System Saver
\$79
- Meiji 5.25 1/2 Height Drive
\$80
- Applied Time II Clock (A.I.)
\$49
- Apricord Parallel Interface
Adapter (/c)
\$54
- No Slot Clock Pro
\$55
- Ext. 80 Col. Card (A.I.)
\$39
- Serial/Parallel Cables
\$19
- AB Switch box (Ser/Par)
\$29
- ABCD Switch box (Ser/Par)
\$39
- A+ Optical Mouse (/c)
\$83
- Disk Notcher
\$10
- Mouse Pad
\$13

WE ACCEPT:  
VISA and MasterCard • Bank Wires
Certified Checks • Money Orders
NO PERSONAL CHECKS
Minimum Order \$50
Sorry, no shipping, insurance
or handling refunds.
Not responsible for
product compatibility.
Prices subject to change without notice.

FEATURE REPORT

APPLEWORKS-COMPATIBLE SOFTWARE

These programs provide increased educational capabilities.

AppleWorks Companion

This disk patches AppleWorks (version 2.0) so that you can use it with RC Systems' Slot-Buster II card (\$149.95) and Speech Synthesizer (\$39.95) to give visually impaired users audio feedback of the screen display. RC Systems suggests the addition of its SCAT (Screen Articulation) disk (\$19.95) for blind users. (\$39.95)

GeoWorld

GeoWorld is a database/simulation that brings concepts in world geology, resource distribution, and rock formation alive. (See "Teachers' Toolbox" in the April 1988 issue for a full description.)

SurveyWorks

SurveyWorks automates the analysis of surveys. The survey is printed directly on the scan sheet, and you can transfer the results directly to AppleWorks files or to any ASCII files. The product requires a Super Serial Card and SCAN-TRON Scanner. (\$195)

TestWorks

TestWorks assists you in scoring and grading tests through the use of a scanning machine. The documentation guides you through the easy process of transferring the results to any AppleWorks grading spreadsheet. The program includes sample AppleWorks grading and resource files and requires a Super Serial Card and SCAN-TRON Scanner. (\$49.95)

TestWriter

The TestWriter program automates the creation of a variety of test types: multiple choice, essay, true/false, fill in the blanks, and matching. The program produces answer keys and multiple versions of the same test. You can write the tests to ASCII files for loading into AppleWorks. (\$39.95)

ThinkWorks

ThinkWorks is a slow but useful program that functions as a stand-alone outline processor. You can easily save the outlines produced with the program as AppleWorks word-processing files. The educational version provides lessons and ideas. (\$99.95, and \$10 per disk)

ORDERS ONLY:
1-800-438-2883
(7 days, 8 am - 5 pm PST)
(AK, HI, & outside CA)
All Prices FOB San Diego

**Roger
Coats**

PRICES QUOTES &
TECHNICAL SUPPORT:
1-619-274-1253
(within CA & outside USA)

15% (\$15 min.) restocking fee

P.O. Box 171466
San Diego, CA 92117

If you don't see it, CALL US!
Next-day delivery available

CIRCLE 109 ON READER SERVICE CARD

RESOURCE GROUPS AND REFERENCES

Besides considering the resources I've already listed, you can get in touch with several organizations that serve as clearinghouses of AppleWorks information.

Teacher Idea & Information Exchange (TI&IE)

TI&IE offers its members a disk subscription that provides the most cost-effective means to obtain AppleWorks resource files, templates, and tips. The educationally focused disks come out about once

Several organizations serve as clearinghouses of AppleWorks information.

a month, with back issues available (six-disk subscription, \$29.95; sampler disk and catalog, \$9.95)

The Apple Library Users Group

The Apple Library Users Group (ALUG) is a group of more than 10,000 librarians and individuals interested in using Apple computers to manage information. Its fine quarterly newsletter is free to all members. ALUG also sponsors the Apple Library Template Exchange, which includes many AppleWorks templates. Write to ALUG for the free template catalog.

The Works Newsletter

The Works offers tips, advice, classroom ideas, and timely articles for teachers and administrators. You also receive reviews and announcements of products as well as updates and highlights of TI&IE and The AppleWorks User Group (TAWUG), two educationally oriented AppleWorks public-domain groups. TAWUG will be covered next month in the third part of this series. (\$19.95 per year [Sept-May])

AppleWorks Accessories

This extensive free catalog of AppleWorks-related products for schools and general use offers the best single source for finding resources for AppleWorks. Prices generally fall in the retail range.

AppleFest AppleWorks Workshops

If you are headed to Boston for

the spring AppleFest (May 19-21), sign up for one or more of the eight-hour workshops for educators, beginners, or advanced users (May 19-21). Each day-long workshop with an AppleWorks expert involves hands-on time and demonstrations. You receive handouts, including public-domain templates, resource guides, how-to articles, and discount offers on

AppleWorks aids. (day-long workshop [lunch included], \$95 each)

David Chesebrough is editor of The Works newsletter, focusing on educational applications of AppleWorks, and has developed an award-winning school computer program based on AppleWorks use. He is responsible for computer education at the Buhl Science Center in Pennsylvania.

ADVANTAGE COMPUTING

60

BEST APPLE PROGRAMS

II+, IIe, IIc, IIgs, LASER 128

ALL FOR \$39.95

(Plus \$4 shipping and handling)



This Special Kit includes:

- ★ 40 Best Apple Programs
- ★ 20 Exciting Apple Games
- ★ 10 Blank Diskettes
- ★ A Sturdy Disk Organizer
- ★ Programs come ready to run on high quality diskettes.
- ★ User friendly; Menu driven
- ★ Same day processing
- ★ Education/Business/Home/Games

TOLL FREE ORDER HOT LINE (800) 356-4666 IN CA (714) 924-5889

• UNCONDITIONAL •

MONEY BACK GUARANTEE

A member of the Better Business Bureau.

YOU WILL RECEIVE ALL OF THESE GREAT PROGRAMS: READING, LETTER DISC, MY SPELLING TEST, APPLE II DEMO, SCRAMBLED WORD, SYNONYM DRILL, MAKING CHANGE STATE CAPITALS, TIME TEACHER, TOM'S MATH DRILL, MATH FACTS, MEET THE COMPUTER, ARITH TAC TOE, LOGIC PRACTICE, GRAMMAR MAD LIB, BASIC TUTORIAL, SOLVE/GRAPH, LINEAR EQU. RECIPE COST, LIFE EXPECTANCY, BOOZE N YOU, JIG-SAW PUZZLE, SEX ROLES, BLACK JACK STRATEGY, ASSERTIVE TEST, ESP TEST, FOLLOW BOUNCING CHIP, MR. APPLE, MUSIC MAKER, MUSIC WRITER, SHOPLIST RECIPE BOX, NUMBEROLOGY, BUDGET MONTHLY, FINANCIAL PLANNER, MARKET EVAL. PAK, CHECKBOOK BAL., RECORD MGMT. SYS., STOCK MARKET, CALENDAR, DECISION MAKER, FOOTBALL NFL, BASEBALL, MONOPOLY, WHEEL OF FORTUNE, BAGELS, KENO, CRIBBAGE, MAROONED IN SPACE, CONCENTRATION, COMPUTER RAPLPH, CONNECTION, CASINO, DEFLECTO, HANGMAN, TIC-TAC-TOE, HI Q, DICTIONARY GAME, CRAPS, TANK, TOWERS OF HANOI.

ORDER FORM

Please send me the APPLE SOFTWARE KIT.

PLEASE PRINT OR TYPE ALL INFORMATION

Name: _____	Best Programs Kit for APPLE \$39.95
Street Address: _____	Shipping & Handling \$ 4.00
City: _____ State: _____ Zip: _____	6% California Sales Tax (CA Residents Only) _____
Phone: (____) _____ Date: _____	Total _____
MAIL ORDERS TO: Advantage Computing 24285 Sunnymead Blvd. Suite #212 Moreno Valley, CA 92388	PAYMENT METHOD: <input type="checkbox"/> Check/Money Order enclosed. <input type="checkbox"/> Master Card/Visa
	Card # _____
1-800-356-4666	Name on Card: _____
CA: 1-714-924-5889	Expiration Date: _____

CIRCLE 273 ON READER SERVICE CARD

FURTHER INFORMATION

Using AppleWorks in the Classroom
Addison-Wesley Publishing Co.
Menlo Park, CA 94025
(415) 854-0300

The Apple Library Users Group
Monica Ertel, manager
Apple Computer, Library &
Information Services 8C
10381 Bandle Drive
Cupertino, CA 95014
(408) 973-2552

AppleWorks Workshops
AppleFest/Boston Conference
and Exposition
Cambridge Marketing, Inc.
One Forbes Road
Lexington, MA 02173
(800) 262-FEST

Customized Gradebooks
Jim Crawford
5048 Springtree Court
Lithonia, GA 30058
(404) 987-0324

Hands-On AppleWorks
Computer Literacy Press
353 East Tenth Street, Suite C-624
Gilroy, CA 95021-2372
(408) 848-1483

The Power of Nation States
Data Disk International
1430 Willamette, Suite 577
Eugene, OR 97401

AppleWorks for Teachers
Franklin, Beedle & Associates
4521 Campus Drive, #327
Irvine, CA 92715-9877
(714) 552-4155

Principals' Pal and
Teachers Aide Series
Hayes Company
242 West Cherry Street
Duncanville, TX 75116
(214) 298-0246

Special Education Student
Information Database
Helen S. Edens, Supervisor for
Computer Education
Chesterfield County Public
Schools
2318 McRae Road
Bon Air, VA 23235
(804) 323-0527

HelpWorks
HelpWorks Software Corporation
P.O. Box 2913
Lubbock, TX 79408
(806) 796-8495

AppleWorks for School Librarians
Hi Willow Research & Publishing
Fayetteville, AR 72702
Written inquiries only

Write On!
Humanities Software
P.O. Box 1064
Hood River, OR 97031
(509) 493-1395

*AppleWorks for Educators—
A Beginner's Workbook*
ICCE, University of Oregon
1787 Agate Street
Eugene, OR 97403
(503) 686-4414

FactWorks
ImagiMedia Software
16640 Roscoe Place
Sepulveda, CA 91343
(818) 891-3707

*AppleWorks in Your Classroom:
A Student Introduction*
J. Weston Walch, Publisher
321 Valley Street, Box 658
Portland, ME 04104-0658
(800) 341-6094

*ClassWorks: AppleWorks for the
Classroom*
International Council for
Computers in Education
University of Oregon
1787 Agate Street
Eugene, OR 97403
(503) 686-4414

AppleWorks Accessories for
School, Office & Home;
SchoolWorks; TestWriter
K-12 MicroMedia
6 Arrow Road
Ramsey, NJ 07446
(800) 922-0401

GradeWorks
Katama Software
RFD 304
Edgartown, MA 02539
(617) 627-5145 (4-8 EST)

Databases in the Classroom: Apple-
Works Sampler; Spreadsheets for
Mathematics & Science: Apple-
Works Sampler; Computing Tools:
AppleWorks; SportsWorks series
MECC
3490 Lexington Avenue North
St. Paul, MN 55126-8096
(800) 228-3504

ThinkWorks
Megahaus
6215 Ferris Square
San Diego, CA 92121
(619) 450-1230

TestWorks, SurveyWorks
Micro-Computers for Education
4246 Schneider Drive
Oregon, WI 53575
(608) 835-5922

Mindscape's Educational Division
Software Catalog-on-a-Disk
Mindscape, Inc.
3444 Dundee Road
Northbrook, IL 60062
(800) 221-9884

NewsWorks I/II/II
Newsweek Education Division
Newsweek Building, Box 414
Livingston, NJ 07039
(800) 526 2595

IEPWorks
NovaSolutions
34 Elm Terrace
Burlington, VT 05401
(802) 658-2614

AppleWorks Video: The First Step
PCR Video, Inc.
45 Pond Street
Norwell, MA 02061
(617) 871-5398

How to Use AppleWorks Video
Computer Network
211 West Fiesta #25
Carlsbad, NM 88220

School Zipfiles
Petit Design
2650 South Shore Drive
Milwaukee, WI 53207
(414) 483-9056

FEATURE REPORT

AppleWorks Companion
RC Systems, Inc.
121 West Winesap Road
Bothell, WA 98012
(206) 672-6909

Teachers Tools
Sage Productions, Inc.
Box 11215
San Diego, CA 92111
(619) 286-8165

Climate and Weather, The
Constitution Then and Now
Scholastic Software
2931 East McCarty Street
P.O. Box 7502
Jefferson City, MO 65102
(800) 325-6149

CareerWorks
Sextant Software
1223 Walnut Street
Latrobe East Industrial Park
Latrobe, PA 15650
(412) 537-3500

LetterWorks for Teachers
Techniforms
P.O. Box 331
Wilkesboro, NC 28697
(919) 667-2981

Computer Activities for the
Classroom—Dinosaur Packet
The Math Learning Center
P.O. Box 3226
Salem, OR 97302
(503) 229-3041

Teacher Idea & Information
Exchange (TI&IE)
Jim Carlisle, director
P.O. Box 6229
Lincoln, NE 68506
(402) 483-6987

The WORKS Newsletter
P.O. Box 72-A
Leetsdale, PA 15056

Videoware
Videoware Products, Inc.
8100 Cambridge, Suite 75
Houston, TX 77054
(713) 790-0772

*Developing and Using Office
Applications with AppleWorks,
Versions 1.0-2.0, Understanding
and Using AppleWorks*
West Publishing Company
50 West Kellogg Blvd.
P.O. Box 43526
St. Paul, MN 55164
(800) 328-9424

HOW TO CONTACT YOUR ADVERTISING REPRESENTATIVE AT



The #1 AppleII Magazine

MARTIN MAZNER
Publisher

JEFF MILLER
Associate Publisher

DAVID J. EZEQUELLE
Advertising Director

EAST

NORTHEAST:

Connecticut, Maine, Massachusetts, New Hampshire, New York, Rhode Island, Vermont, Eastern Canada

EUROPE:

THOMAS E. RICHARDSON
Ziff-Davis Publishing Company
One Park Avenue, New York, NY 10016
(212) 503-5145

MID-ATLANTIC:

Alabama, Arkansas, Delaware, District of Columbia, Florida, Georgia, Kentucky, Louisiana, Maryland, Mississippi, New Jersey, North Carolina, Ohio, Pennsylvania, South Carolina, Tennessee, Virginia, West Virginia

PETER STANGEL
Ziff-Davis Publishing Company
One Park Avenue, New York, NY 10016
(212) 503-5153

MIDWEST

Illinois, Indiana, Iowa, Kansas, Michigan, Minnesota, Missouri, Nebraska, North Dakota, Oklahoma, South Dakota, Texas, Wisconsin

THOMAS LUTZKE
Ziff-Davis Publishing Company
180 N. Michigan Avenue, Chicago, IL 60691
(312) 346-2600

WEST

NORTHWEST:

Alaska, California (93600 and up), Colorado, Idaho, Montana, Nevada, Oregon, Utah, Washington, Wyoming, Western Canada

SUSAN E. SCHLANGEN
Ziff-Davis Publishing Company
950 Tower Lane, 18th Floor, Foster City, CA 94404
(415) 378-5699

SOUTHWEST:

Arizona, California (93500 and down), New Mexico

CATHERINE DAVENPORT
Ziff-Davis Publishing Company
3460 Wilshire Blvd, Los Angeles, CA 90010
(213) 387-2100

18 prescriptions for a healthy ImageWriter

Preventive Printer Maintenance

What is your ImageWriter worth to you? This popular printer will last essentially the life of your Apple, provided you take reasonable care of it. Since it costs around \$500, you can ill afford to treat it badly.

An ink buildup on the print head can produce smeared characters, and it may contribute to jamming of the print-head pins (about a \$100 repair job). The foil print shield can tear and scratch the platen, which can require a \$75 repair job. Also, a ribbon that is wound too tightly can cause the drive mechanisms in the ribbon-frame assembly to break, adding another \$20 replacement bill. Unless you can replace a platen or circuit board yourself, you have to consider the labor charges that quickly accrue.

This article presents 18 simple ways to assure you will get optimal use of your printer while avoiding repairs. But first, make sure your ImageWriter and Apple are positioned on a firm table or desk, close to a wall socket, in a secure area.

1. All cables should be properly hooked up.

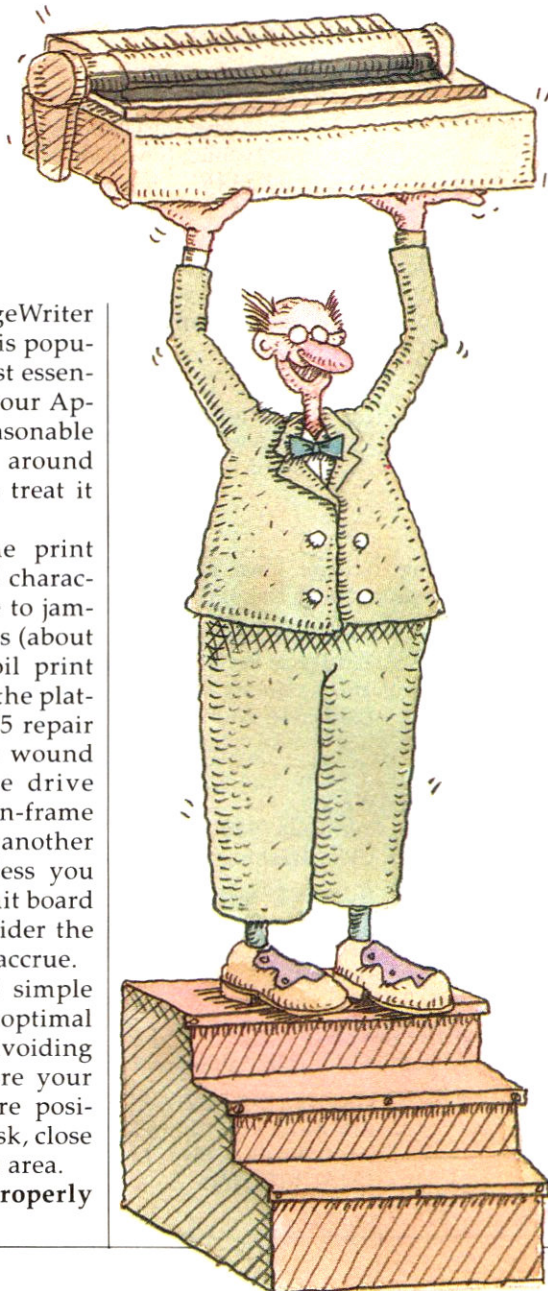

The ImageWriter requires its own power source, and it should be plugged into a three-hole grounded outlet. To avoid shocks and possible damage to the circuitry, leave the printer and the computer off while hooking them up, and use tightening screws to secure the connection firmly in place.

2. Plug your printer into a surge protector.

Even though the ImageWriter does not have all of the sensitive chips of the Apple, electrical fluctuations can still damage the circuits. The cables use a metal wrap-around shield to reduce the effects of radio-frequency interference, but on days of thunderstorm activity or power disturbances, don't give your printer the \$500 test. Although most protectors cannot overcome a major power surge, they help moderate the minor fluxes, so they are worth having.

3. Ban food and drinks in the work area.

You've heard it a million times before, but the number 1 taboo for the Apple office is setting your coffee and morning Danish beside your keyboard or printer. If by the

slightest chance a few drops of coffee or crumbs of jelly doughnut fell inside, they could cause a short circuit (along with some rather high repair bills).

4. Keep the work area dusted and the printer covered.

No matter how neat a work area may be, dust always seems to accumulate. Dust particles are everywhere, but covering the printer (and computer) during long periods of disuse reduces the exposure of your equipment. Dust the work area about once a week.



Dust covers vary widely in materials and price, from tailor-made leather with gold trim to an ordinary bed sheet.

5. Watch the paper flow.

When using track-fed paper, avoid letting the output pile on top of the printer. To avoid jamming, don't cram a large quantity of paper under the printer intake. Printer stands work nicely, or try keeping the box of paper on the floor and allowing the printed output to flow off the table into a stack.

6. Use paper of the proper weight.

Avoid using paper that is less than 16 pounds (unless you add a couple sheets), because the impact of the print-head pins can damage the platen. Using paper a little heavier than 24 pounds presents no problem, as long as you adjust the thickness gauge accordingly.

7. Use a good ribbon.

As the ribbon wears, further impact by the print head may cause the fibers of the cloth to unravel and jam the head. Using a re-inked ribbon is fine, but the greater the usage, the greater the chances of its becoming frayed.

8. Properly align the paper, envelopes, and labels.

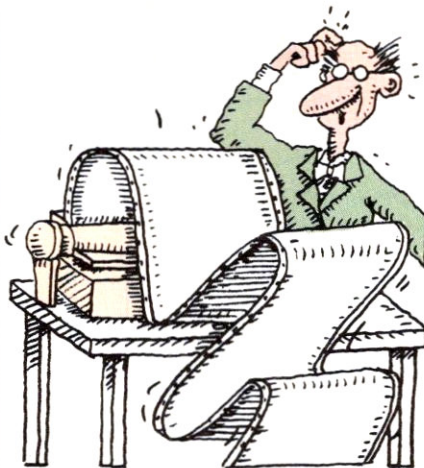

The ImageWriter can handle a wide variety of materials, but if you don't correctly position them in the paper feed, they can get jammed. For multiple forms, envelopes, and labels, adjust the thickness gauge to assure enough space for the print head to move back and forth properly.

You can usually force out self-stick labels that get caught, by feeding in several sheets of paper (turn the platen knob by hand).

9. Run the printer self-test, and don't change the DIP switches.

The self-test shows the printer output, which should be crystal clear and readable. If not, check the ribbon for wear and proper alignment before contacting your Apple dealer.

The DIP switches come preset, so unless you have a particular need, don't change them (or first consult your dealer).

10. Place a foam pad under the printer.

If you place a 1/2-inch foam pad under the printer, it becomes much quieter and experiences less vibration of its semifragile inside.

11. Periodically dust the inside of the printer.

With all of its moving parts, a printer is more susceptible to dust damage than a computer is. Use a slightly moistened soft rag with water or alcohol to remove the bits of paper and dust that accumulate inside, at least once a month. A can of compressed air (available at most camera shops for about \$5) also works nicely.

The carrier rod should also remain free of dust, and a drop or two of a light high-quality oil helps keep the rod lubricated.

12. Regularly clean the outside.

Damp-rag the outside of the printer to remove dust as often as once a week. Clean any stains on the printer by using a mild liquid dish soap—never use cleansers or solvents.

13. Clean the print head.

Periodically, you should clean the print head to remove ink build-ups, which also reduces the chances of jamming. Cleaning ribbons are available that remove ink residue; they're especially handy when you're swapping color ribbons, to prevent darker ink from getting onto the cloth of lighter-colored ribbons.

You can remove the print head by carefully bending back the pointed white tab and pulling up. Be patient—it's a snug fit. Once you've removed it, use alcohol on a cloth and lightly rub it over the pins until the red square appears. Take great care when replacing the print head, so as not to bend the metal tabs.

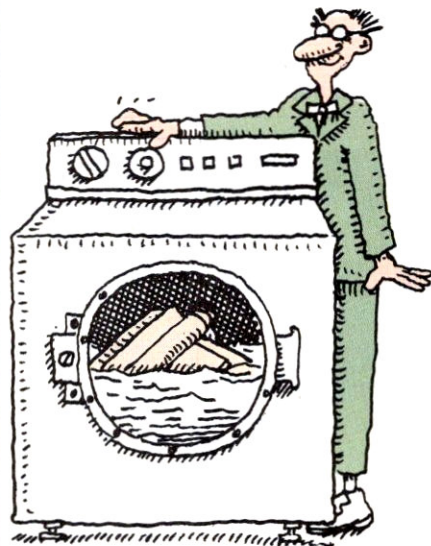

Aside from using a cleaning ribbon or removing the print head, using a little alcohol on a thin rag can also remove remnant ink. Just dampen the edge of the cloth and pass it back and forth in front of the print head.

14. Clean the paper guide and print shield.

Ink can also accumulate on the paper guide, which can cause smudge marks. Just unscrew the guide, take an alcohol-dampened cotton swab, and lightly brush the inside. If you remove the print head first, you can completely free the plastic guide.

The foil print shield may lose its stick and can get caught on the paper, resulting in a severely scratched platen. If it starts to come loose, remove it.

15. Keep the platen clean.

You can clean the platen with a cloth dampened with alcohol, which helps remove any ink stains and dirt. Don't print directly on the platen, or you'll get an uneven print surface.

16. Inspect and clean the ribbon-frame assembly.

Regularly inspect and clean the ribbon-frame assembly, which holds the cartridge in place—bits of paper and dust gather there also. When you turn on the printer, watch the centering of the ribbon, since the assembly can get out of alignment. Just notify your dealer if it needs adjusting.

The drive mechanisms on the frame assembly can break if you are using a tightly wound ribbon (often caused by too much cloth inside the cartridge). Simply pull some out, cut off the excess cloth, and rejoin the ends with a couple drops of super glue (or just throw away that cartridge).

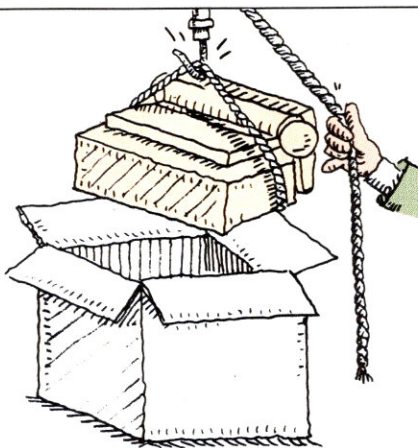

17. Pack the printer when moving it.

If you're moving your printer beyond the confines of your home or office, then carefully pack it in the original box and place the styrofoam pads around it. Also insert the carrier-rod tubes to prevent the print head from moving during transport. If neither the original box nor the carrier-rod tubes are available, place socks or soft cloth inside to prevent the print head from moving and wrap the printer with a blanket before placing it in-

side a sturdy box. Also place the printer inside a plastic bag (such as a trash bag) and tape the box (especially for long journeys).

18. Consider buying Apple Care.

If your printer and computer are a key part of your livelihood, or if you would rather not risk the expenses of possible repairs, then get a service contract from your Apple dealer. Apple Care for the ImageWriter—an insurance policy against any wear, defects, or problems that may arise—costs about \$5 a month.

Don't Forget the TLC

The ImageWriter is too expensive to let simple disregard ruin it. It was designed to last for years without lubrication or servicing, and it can provide an almost endless supply of high-quality output from your Apple. +

Scott Brainard is a freelance writer and graduate student at Humboldt State University in California, where he uses his ImageWriter extensively. As a editor in quality control at a software firm, he learned firsthand how simple maintenance can stave off costly repairs.

COMPUTEREYES™



Color Video Images for your GS: \$249⁹⁵
Monochrome for any Apple II: \$129⁹⁵

Now you can easily and inexpensively digitize high quality images from any standard video source – videotape, camera, disk – for display on your Apple. Capture time is less than six seconds, and you have complete control of displayed color levels (or gray scales in monochrome).

ComputerEyes has everything you need: Interface hardware, complete easy-to-use software support, and owner's manual. It fully supports all Apple graphics modes and the images are compatible with virtually all popular graphics programs.

Think of the possibilities!

ComputerEyes is backed by a one year warranty and the success of over 10,000 systems sold. Satisfaction guaranteed or return within ten days for refund. Demo disk available, \$3.

See your dealer or order direct. For more information call 617-329-5400.

To order call 800-346-0090

or mail your order to: Digital Vision, Inc.
66 Eastern Avenue, Dedham, MA 02026
VISA, M/C, or COD accepted. S&H, \$4.

**DIGITAL
VISION**

For Free Information...

...on any product you see advertised or read about in *A+* Magazine, look for the Reader Service Number and mark it on the Reader Service Card found in the back of this issue. The manufacturer will send you additional information free!

CIRCLE 169 ON READER SERVICE CARD

SPEAKING OF GRAPHICS

The Graphics Studio and its eccentric user interface

BY MICHAEL CALLERY AND ROBERTA SCHWARTZ

Sometimes a program's release follows such a blast of prerelease gossip, "beta leaks," and hullabaloo that you can't help but know it's there. DeluxePaint II for the IIGS was such a program. And then sometimes a program appears out of nowhere—Accolade's *The Graphics Studio*, another paint program for the Apple IIGS, is an example.

Since most Apple IIGS owners already have a paint program—Paintworks Plus, 816/Paint, or DeluxePaint II—they would have to have a pretty good reason to switch to *The Graphics Studio*.

We can think of a couple of good reasons for switching to a new program: It's either so easy to use that it puts the competition to shame, or it's got so many features that you can't do without it.

Of the competition in the GS paint category, DeluxePaint II dominates on the feature count, and Paintworks Plus wins on the ease-of-use count. So what about this new kid on the block? Let's start with ease of use.

The part of a coupteur program that you work with is called the user interface. Does it have a command-line prompt, or do you select commands from a menu? Does the whole screen scroll or only part of it? Which keys do you press to accomplish a function? These issues, and many others, are user-interface questions.

The real controversy over the

user interface started with the Macintosh. The early Apple software for the Mac (the Finder, MacPaint, MacWrite, MacDraw, and so on) set the standard: mouse, windows, pull-down menus, icons, and so on. An important factor in rating Mac software is now whether or not it "follows the interface," because a consistent interface is so important to Mac users.

a desktop interface on the Apple IIGS. Programs such as MultiScribe, Paintworks Plus, and Draw Plus—and, indeed, most of the newer productivity software—have embraced this interface. The desktop interface has proven easy to use, and standardizing it has a distinct advantage: Once you've learned how to use one piece of software, learning to use another one is much easier.

Besides the "look and feel" Apple itself has fostered, there's another kind of standard interface: The popularity of a certain product in the market can make that product's features a de facto standard. In this case, the program that many others have imitated is MacPaint, which has inspired the

PROGRAM MARCHES TO OWN DRUMMER

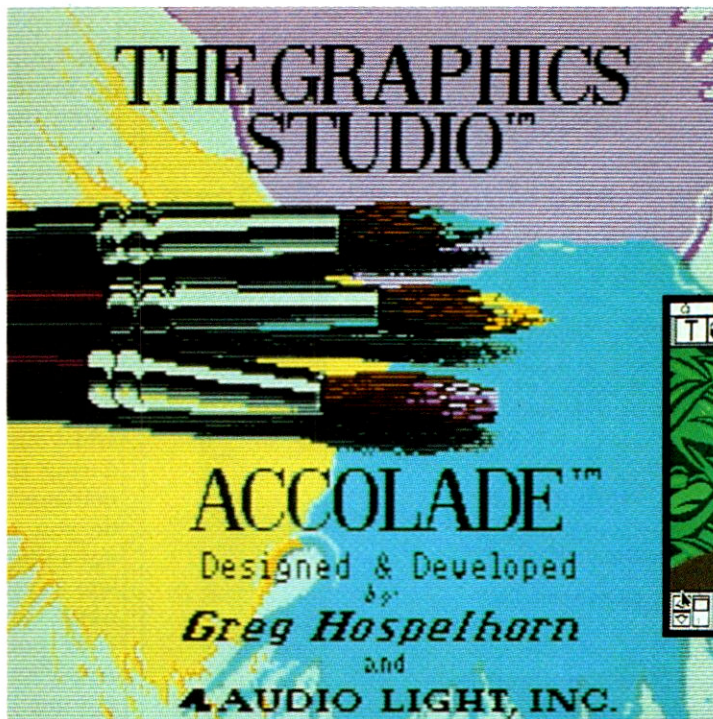

The Graphics Studio opening screen (left) and menu bars (above)

The success of the Macintosh led Apple to create a Human Interface Group to codify and refine the components of the "desktop interface," and the increased power of the Apple IIGS led to adoption of the desktop interface as the standard for graphics programs on the Apple II. Programmers finally got the system software to easily create

icons, patterns, and general screen layout of both Macintosh and GS paint products.

Therefore, we come to an Apple IIGS paint program with a certain set of expectations. We expect tool palettes with icons for brushes as well as line and polygon tools, a marquee (or edit box), a lasso, a spray can, a paint bucket (for fills),

a hand (for scrolling), a magnifying glass (for zoom editing), and a text tool. We expect a color/pattern palette. We expect a standard menu bar at the top of the screen. We know the menu and the tool and color palettes will obscure part of our drawing so that we have to scroll to paint on the full page.

Of the IIGS paint programs on the market, Paintworks Plus wins the interface test hands down. If you know the interface, it takes ten minutes at best to become comfort-

Of the IIGS paint programs, Paintworks Plus wins the interface test hands down.

able with Paintworks Plus. 816/Paint and DeluxePaint II add their own twists to the interface.

The question is whether the user interface should become a criterion for judging software. More defini-

tively stated: Should a program be subject to criticism because it doesn't follow the Apple desktop interface? What if some programmers feel they can do it better?

Interface

The Graphics Studio deviates from the desktop-interface guidelines in several ways, although on cursory examination it looks as though it adheres to them. There is a menu bar at the top of the screen, but it disappears when you are not near the top of the screen. When you are painting or selecting from the tool options, it shows the current tool or function. (You can turn this feature off so that the normal menus show all the time.)

When you access a pull-down menu and click on your selection, the menu does not go away; it stays there. Accolade claims that a "stay-down" menu lets you make multiple selections from the same menu without having to pull it down more than once. We agree, but the Apple guidelines say that multiple choices such as these should be available in dialog boxes, not menus.

On the subject of dialog boxes, The Graphics Studio's dialog boxes are clearly hand-honed. Instead of using the standard file-dialog box boxes for Save and Load, the programmers obviously did their own thing rather than depend on Apple's tools. We really don't care how they created their dialog boxes, but the boxes should act the same as those created with the GS tool sets. They don't. When you are typing a filename, you cannot use the arrow keys to edit the name, and your pointer disappears, rendering the mouse useless. We can manage without editing, but how do you cancel the operation without a pointer? Answer: Use the Delete key to erase all that you may have typed; then press Return. Your pointer will reappear. Isn't Apple's way easier? Just move the pointer to the Cancel button and press the mouse button.

Instead of placing all the tools on the screen as other programs do, The Graphics Studio uses "pop-up" menus. When you select the rectangle tool, for example, and hold down the mouse button, a new menu unfolds with six more options, such as filled rectangle and rounded rectangle. Ideally, this

Checkmate Technology



A Leader in Innovative Technology

A Superior Quality Product—Seven Year Warranty

Checkmate's top-quality products have just gotten better! New processes and techniques instituted in our Tempe manufacturing facility have resulted in enhanced durability, dependability and product value. Because of this, all Checkmate hardware products now come with our **Seven Year Limited Warranty**—our promise to deliver our best quality ever!

Checkmate Technology's name on the label means you're getting high quality, innovative products with unequalled service at affordable prices. All products carry our Upgrade Guarantee—as new products come out, you can use your original investment when you add features or change systems.

Superior quality, innovative products, unequalled service and our Seven Year Warranty—WHY SETTLE FOR LESS? Ask your dealer for Checkmate Technology's products today. For information about all of Checkmate's superior quality products for Apple IIGS, Apple //e, Apple //c and Macintosh systems, call our TOLL FREE number for prompt, friendly service.

The MemorySaver™ and MultiRam™ GS Team

The MemorySaver™ ROM Disk System

- The *original* ROM disk system for the Apple IIGS (patent pending).
 - Battery backup provided to keep your programs intact.
 - Speeds operation of many programs like a solid-state hard disk drive! Reduce long waits for program loading.
 - Compatible with all popular RAM cards for the GS.
 - Includes software, manual and our *superior quality!*
- **MemorySaver™** **\$149.95**

The NEW MultiRam GS Memory Card

- Adds up to 2 Megabytes of memory to your IIGS.
 - Accepts inexpensive 256K chips and high-density 1 Megabyte chips.
 - Includes software, manual and our *superior quality!*
- **MultiRam™ GS (256K)** **\$189.95**

ACT NOW! Save \$20.00 when you purchase a MemorySaver and MultiRam GS combination—just \$319.95

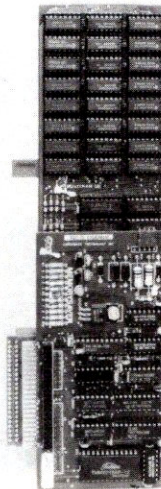

MemorySaver and MultiRam GS

Checkmate Technology, Inc.



509 S. Rockford Drive, Tempe, Arizona 85281
(800) 325-7347 • (602) 966-5802



CHECKMATE MEANS SUPERIOR QUALITY!

Apple IIGS, Apple //e, Apple //c and Macintosh are trademarks of Apple Computer, Inc. All prices subject to change without notice.

CIRCLE 127 ON READER SERVICE CARD

approach should make the screen display less confusing, but we found it disorienting because we couldn't see all the tools and options. Furthermore, unlike the pull-down menus at the top of the screen, the pop-up menus for the tools don't remain on the screen—they disappear when you select a function. This disappearing act makes sense, since you can select only one tool at a time, but it does do a bit of damage to one of the prime rules of the Apple desktop interface: consistency.

Here's another bothersome quirk in this program: The copy/edit functions in most paint programs require you to select the edit box and then choose Copy, Flip, Horizontal, Cut, and so on. Apple's interface guidelines require a noun before a verb: First you select an area, and then you decide what to do with it. In The Graphics Studio, you must decide what to do before you select an area, and each edit function requires a different tool.

The final blow of the Accolade interface is that it does not allow access to any desk accessories, classic or new. The apple menu at the far left of the menu bar contains only About . . . , and Control/open-apple/Esc is locked out. OK, guys—we just got this great scrapbook from StyleWare, and we can't use it in The Graphics Studio. Score a minus 10 for the interface.

Tools and Functions

The Graphics Studio features a good collection of tools and functions, somewhere between Deluxe-Paint II's dazzling array and the basic set of Paintworks Plus. The program lacks 3-D effects, a lasso, gradient fills, and antialiasing (smoothing). The implementation of the existing tools is as eccentric as the interface.

In The Graphics Studio, your working icon is always a large, outlined cross hair (rather than a pencil, paint bucket, or spray can). The cross hair lets you position your tool, but it disappears as you're working. Thus, as you are painting, you don't see anything but the paint stroke, which makes it hard to pinpoint your location on the screen. All the competing IIGS paint programs use an inverse brush to let you see where your brush is while you are painting.

The Graphics Studio's Zoom

*Our enthusiasm for
The Graphics Studio's
Zoom mode is mitigated
by a paucity of tools.*

mode, though, approaches greatness. The top half of your screen shows the actual-size image, and the bottom half shows the enlarged area. Instead of scrolling the zoomed area with the hand or

scroll bars, you look at a rectangle on the actual-size image that shows the zoomed-in area; to scroll you move the rectangle. Our enthusiasm for the Zoom mode is mitigated by a paucity of tools, however. Only a pencil and fill are available in the Zoom mode. You find the Zoom mode under the freehand-tool icon—yet another example of a user interface designed by the Mad Hatter.

Color, or palette, editing is unique. The top half of the screen



IT ISN'T OVER 'TIL IT'S COVERED

Your computer has become an integral part of your lifestyle, therefore appropriate steps should be taken towards its care and maintenance. When you decide to treat your computer to the finest dust covers money can buy, **COMPUTER COVER COMPANY** can deliver. We design and fit an individual cover for each component in your computer system. Our commitment to quality, superior workmanship and customer satisfaction is evident throughout our entire line of products.

Have you ever tried vinyl, naugahyde or cloth dust covers? If you have, then you can appreciate why our covers are constructed from 400 Denier Rip Stop Nylon. Our covers are water and static resistant, they **will not tear, crack or create lint problems.**

		IIC Cover Sets	Base Price*
Set #			
200	Monitor, CPU/Keyboard, Mouse		\$20.95*
210	Monitor, CPU/Keyboard, Mouse, External Drive		\$23.95*
220	Monitor, CPU/Keyboard, Mouse, Printer		\$29.95*
230	Monitor, CPU/Keyboard, Mouse, Printer, External Drive		\$31.95*
		IIGS Cover Sets	Base Price*
Set #			
300	Monitor/CPU, Keyboard, Mouse		\$29.95*
310	Monitor/CPU, Keyboard, Mouse, External Drive		\$31.95*
320	Monitor/CPU, Keyboard, Mouse, Printer		\$37.95*
330	Monitor/CPU, Keyboard, Mouse, Printer, External Drive		\$39.95*

Macintosh and IIGS Cover Sets Available.

Imagewriter Ribbons

	Box of Six	5 or less
Black	\$21.95/\$3.66 ea.	\$4.50 ea.
Solid Color	\$26.95/\$4.50 ea.	\$6.00 ea.
Multicolored I/W II	\$52.50/\$8.75 ea.	\$10.00 ea.

Slip Ups

Our own special mouse pad measures 8" x 9 1/2". Available in three colors: BLUE, GRAY and RED. Regularly \$6.95

FREE — SLIP UP
With every cover set purchased!

PAK UPS

Diskette holders designed for your traveling and storage needs, that will slip into your coat pocket, purse or briefcase with ease. Velcro closure holds your diskettes safe and secure. Available for your 5.25" diskettes and in two sizes for 3.5" diskettes.

	Regularly	Direct Order	2 For
3.5" Small PAK UP holds 1 or 2 diskettes	\$5.95	\$4.95	\$7.95
3.5" Big PAK UP holds up to 8 diskettes	\$9.95	\$7.95	\$12.95
5.25" PAK UP holds up to 9 diskettes	\$9.95	\$7.95	\$12.95

Colors: Bone, Tan, Blue, Platinum, Brown, Red, Black, Smoke and Green.

ORDER FORM:

IMPORTANT: To avoid delays and reshipping charges, read carefully and complete fully. Thank you.

APPLE IIC SET # _____		BASE PRICE \$ _____	Include any extra charges
NAC = No Additional Charge			
Monitor:	<input type="checkbox"/> IIC Monochrome [NAC] <input type="checkbox"/> IIC Color (add \$1.00)	\$ _____	\$ _____
Keyboard:	<input type="checkbox"/> IIC CPU/keyboard [NAC]	\$ _____	\$ _____

APPLE IIGS SET # _____		BASE PRICE \$ _____	Include any extra charges
NAC = No Additional Charge			
Monitor/CPU:	<input type="checkbox"/> One piece cover [NAC] <input type="checkbox"/> Individual covers (\$4.00)	\$ _____	\$ _____
Keyboard:	<input type="checkbox"/> Standard IIGS keyboard [NAC]	\$ _____	\$ _____

PRINTERS:

<input type="checkbox"/> Standard Imagewriter [NAC]	<input type="checkbox"/> Imagewriter II (add \$1.00)	<input type="checkbox"/> 15" Imagewriter (add \$2.00)	\$ _____
<input type="checkbox"/> Imagewriter II w/sheet feed (add \$5.00)	<input type="checkbox"/> Scribe [NAC]	<input type="checkbox"/> Laserwriter (add \$5.00)	\$ _____

EXTERNAL DISK DRIVES:

<input type="checkbox"/> Unidisk 3.5 [NAC]	<input type="checkbox"/> IIGS Disk II [NAC]	<input type="checkbox"/> IIGS 5.25" [NAC]	\$ _____
<input type="checkbox"/> Unidisk 5.25 (add \$1.00)	<input type="checkbox"/> Stacked UNI 3.5 (add \$1.00)		\$ _____
<input type="checkbox"/> Stacked UNI 5.25 (add \$2.00)	<input type="checkbox"/> Stacked UNI 3.5 atop UNI 5.25 (add \$2.00)		\$ _____

Color Choice: Bone Tan Blue Platinum Brown

*** FREE Slip Up with each Cover Set Purchased ***

\$ [NAC]

Name _____	Subtotal	\$ _____
Address _____	CA residents	\$ _____
Zip _____	add 6% sales tax	\$ _____
Daytime Phone (_____) _____	U.P.S. Ground	\$ _____
Payment enclosed <input type="checkbox"/> Bill my Visa <input type="checkbox"/> M/C <input type="checkbox"/>	(foreign orders/FPO/APO extra)	\$ 3.00
Card # _____ Exp.: ____/____	Total	\$ _____
Signature _____		

Mail Orders Directly to **COMPUTER COVER COMPANY**: P.O. Box 3080, Laguna Hills, CA 92654
Orders Only: CA (800) 237-5376 ★ Outside CA (800) 235-5330 ★ Inquiries: (714) 380-0085

Prices Effective January 1, 1987 - Prices Subject To Change Without Notice

AT 87

shows your image, so you can see the effects of palette edits immediately. If you're not sure which color you used for a particular area, all you have to do is move the cursor up to your image and click on the color you want, and it will appear in the Edit box. In addition to the now traditional RGB slider controls, The Graphics Studio offers a color-editing box. Here, one value (red, green, or blue) is constant. The editing box contains a small square. As you move the square, the other two values change. For example, if you make red constant, moving the small square in the color-editing box changes the green and blue values. Just keep moving the square around, and you'll get 256 different colors from which to choose.

The Graphics Studio offers color cycling along the lines of 816/Paint; that is, it cycles through different palettes rather than within a single palette as does DeluxePaint II. The implementation of the color-cycling edit box is confusing. In 816/Paint you can see all the available palettes, but in The Graphics Studio you can see only one palette

at a time. You must use a scroll bar to move through the different palettes and use buttons to add palettes to and subtract them from the cycle.

Preferred Patterns

The Graphics Studio's pattern editing is more to our liking. You can make any area of the screen a pattern. A pattern editor allows you to fine-tune the pattern, create an entirely new one, swap a pattern (only 6 patterns are available in the pattern palette, but the program keeps tabs on 18 of them), or load one from a picture or a pattern file. You can also save your patterns to a file.

We could go on; every tool has its idiosyncrasies. All in all, we give the tool selection an 8 out of 10, but the implementation of these tools drops the score considerably, and such tools in an eccentric environment make a program hard to use. Hold off on this one until Accolade cleans up its act.

On the Horizon

We're looking forward to AppleFest in Boston. Look us up at the A+ booth if you're there. Until next month—if not sooner. +

VITAL STATISTICS

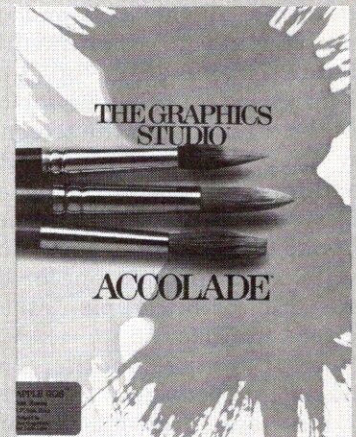

THE GRAPHICS STUDIO

An eccentric paint program whose unusual tool implementation and deviations from the standard desktop interface make it more difficult to use than it should be

- CPU:** Apple IIgs
- RAM:** 768K
- DISK DRIVES:** one 3.5-inch
- OPERATING SYSTEM:** ProDOS 16
- MOUSE:** required
- COPY PROTECTION:** yes (key-disk system)
- LIST PRICE:** \$69.96

Accolade
20813 Stevens Creek Blvd.
Cupertino, CA 95014
(408) 466-5757

CIRCLE READER SERVICE NO. 351

80C/64K CARD \$39.95

Apple Compatible Cards and Products

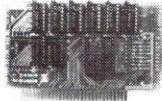

JE864

16K RAM Card (Language Card) for Apple II and II+ — expand from 48K to 64K.

JE860. \$39.95

Extended 80-Column Card for Apple IIe. Doubles the display and memory capacity of your Apple IIe.

JE864. \$49.95 \$39.95

Disk Drive Controller Card for Apple II, II+ and IIe. Capable of handling 2 drives (including ADD12, right)

JE875. \$49.95

Parallel Centronics Printer Card for Apple II, II+ and IIe. Compatible with most of today's popular dot matrix printers.

JE880. \$49.95

64K Buffer Card for above JE880. Compatible with Apple II, II+ and IIe. Software included.

JE883. \$49.95

Prometheus 1200/300 baud, internal plug-in Modem for the Apple II, II+, IIe and IIgs

PM1200A2. \$199.95 \$179.95

12" Monochrome Green Monitor for Apple II, II+, IIe and IIc, with tilt/swivel base.

AMON. \$99.95

IIc to ImageWriter II or modem cable — 6 feet long.

APC1. \$6.95 \$7.95

IIe to ImageWriter II or serial cable — 6 feet long.

APC2. \$12.95 \$9.95

CMS 20MB Hard Disk Drive

for Apple IIe and IIgs



1-Year Warranty!

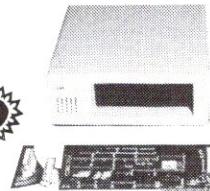

Built to Apple's specifications the CMS SD20A2S includes a 20MB stackable hard disk drive and SCSI interface card which will support two CMS hard drives or two partitions on the same drive.

SD20A2S 20MB Hard Disk with SCSI Controller Card. \$699.95

Laser 5 1/4" Half Height Disk Drive

for Apple II, II+ and IIe



• Direct drive • 160K storage • 40 tracks • Super quiet • Works with Apple Controllers or other Apple compatible controllers (JE875, see left)
• Complete with connector — just plug into your controller

ADD12 Disk Drive (for II, II+ and IIe). \$99.95

AAM Adapts standard Apple drives for use with IIc. . . \$4.95

5 1/4" Half Height Disk Drive for Apple IIc

Same specs as ADD12 (above) except no controller needed.

ADD2C Disk Drive (for IIc). \$109.95

ZOOM 300 Baud Modems

for Apple II, II+ and IIe

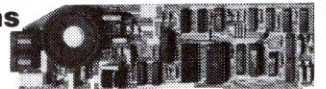

ZM300

• 300 Baud • Manual Dial/Manual Answer • Hayes compatible • Incl. ZOOM communications software

NM300. \$29.95

• 300 Baud • Auto Dial/Auto Answer • Hayes compatible • Includes ZOOM communications software

ZM300. \$74.95 \$49.95

• Software enhancement for the NM300 and ZM300 modems • Allows Xmodem file transfer • Allows storage, editing and printing of files

NMS. \$19.95

2400/1200/300 Baud External Modems

for Apple II, II+, IIe, IIc and IIgs



• Hayes command compatible • Bell 103/212A compatible • Auto-dial/auto-answer • Auto-protocol selection • FCC approved • 1-yr. warranty
• Software not included • Serial card needed for operation excluding IIgs (See AP140, below)

1200C 1200/300 Baud Ext. Modem. \$119.95

2400E 2400/1200/300 Baud Ext. Modem. \$219.95

AP140 Super Serial Card for Apple II, II+ & IIe. . . . \$ 79.95

Additional Apple Compatible Products

KHP4007 Switching Power Supply (for II, II+, IIe) \$34.95

APF Cooling Fan (for II, II+, IIe). \$29.95

1355 SHOREWAY ROAD
BELMONT, CALIFORNIA 94002
ORDER HOTLINE (415) 592-8097
Telex#176043 FAX (415) 592-2503
ALL OTHER INQUIRIES (415) 592-8121



APPLE, APPLE II, II+, IIe, IIc, IIgs and Macintosh are registered trademarks of APPLE Computers

© 1988 Jameco Electronics

5/88

CIRCLE 308 ON READER SERVICE CARD

Preferred Computing

ORDER

TOLL FREE

1-800-327-7234

Computer Accessories

When Only the Best Will Do!



We only sell proven products that work. By selling only the industry best, we can assure you of the highest level of reliability and performance. Selling large volumes of a smaller product line allows us to have the lowest discount prices and fast same day shipment.

AE APPLIED ENGINEERING™

RamWorks III® If you have a IIe this card is perfect, and if you use AppleWorks, it's an absolute must! Stay current with latest software (FREE AE SOFTWARE UPGRADES.) Why settle for a partial compatible? Get the real RamWorks III at a discount price.

RamWorks III 256K.....	\$159
RamWorks III 512K.....	\$219
RamWorks III 1 MEG.....	\$339
RamWorks III 1.5 MEG.....	\$519

RamWorks RGB Options™ New Color-Link RGB Option for Apple analog style, and IBM 9 pin digital monitors..... **\$99**
 RGB Digital Prism Option for Apple Color 100 and IBM 9 pin digital monitor... **\$99**

512K RamWorks Expander piggyback for all RamWorks boards..... **\$219**

2 MEG Plus RamWorks Expander™ For RamWorks basic, II, and III. Uses 1 MEG RAMs..... **CALL**

256K RAMs Compatible with all memory cards that use 256K RAMs. Set of 8... **\$59**

1 MEG RAMs Set of 8... **CALL**

PC Transporter™ & Accessories Your Apple IIgs, IIe, or II+ becomes a IBM PC/XT Compatible. Run MS-DOS programs like Lotus 123, D-BASE, Wordperfect, SideKick, DAC Easy Acct, Crosstalk, and many others. Compatible with Apple Monitors, printers, Hard disks, 3.5 drives, modems, etc... **IN STOCK**

384K (256K IBM)..... **\$379**

768K (640K IBM)..... **\$499**

IIgs Install Kit..... **\$40**

IIe Install Kit..... **\$34**

Single Disk Drive..... **\$209**

Timemaster II H.O™ Has the most features and is easiest to use. Automatically recognized by ProDOS. Includes AppleWorks time display patch. It even adds 15 new commands to BASIC, II+, IIe, IIgs **\$73**

Serial Pro™ Multifunction card for II+, IIe & IIgs with serial ports, and clock/calendar..... **\$102**

Parallel Pro™ Parallel printer interface card compatible with the II+, IIe & IIgs **\$79**

Buffer Pro™ Printer buffer for Parallel Pro. Remain working on documents while printing.
 Buffer Pro with 32 page buffer..... **\$79**
 Buffer Pro with 128 page buffer... **\$119**
 Buffer Pro with 256 page buffer... **\$149**

RamFactor™ Slot 1-7 memory expansion card runs AppleWorks on II+, IIe & Franklin. Battery back-up option for permanent storage.
 RamFactor 256K..... **\$199**
 RamFactor 512K..... **\$259**
 RamFactor 1 MEG..... **\$379**
 RamCharger Battery back-up option **\$139**

gs-RAM™ & gs-RAM Plus™ These cards offer much greater performance and expansion capabilities than Apple' IIgs memory card. Includes AE Cache, AppleWorks desktop expansion, printer buffer, time display, self diagnostics utility, DMA compatible, and much more.

gs-RAM 256K.....	\$159
gs-RAM 512K.....	\$219
gs-RAM 1 MEG.....	\$339
gs-RAM 1.5 MEG.....	\$459
gs-RAM Plus 1-6 MEG.....	CALL

RamKeeper Battery back-up for gs-RAM..... **\$139**

Z-Ram Ultra™ Compatible with all IIc systems

Ultra 1 256K.....	\$169
Memory only 512K.....	\$229
Ultra 2 256K.....	\$229
Memory, Clock 512K.....	\$289
1 MEG.....	\$409
Ultra 3 256K.....	\$279
Memory, Clock 512K.....	\$339
CP/M 1 MEG.....	\$459

IIc System Clock Plugs into IIc serial port. Time display patch supports versions 1.0 to 2.0 of AppleWorks..... **\$39**

DataLink 300/1200 baud internal modem for the II+, IIe and gs. Compact design, Hayes AT compatible, auto dial, auto answer, X-modem file transfer, speaker for call progress status, all built-in. Macro capable software for the IIe & IIgs, phone cord, and manuals..... **\$159**

Z-80 Plus™ Runs all Apple CP/M software. Includes operating system and manuals. For the II+, IIe, and IIgs..... **\$109**

Phasor™ Simply the best sound and speech synthesizer for the II+, IIe, and IIgs... **\$139**

Heavy Duty Apple Power Supply Direct replacement for II+ and IIe supply with over twice the output of the stock supply **\$59**

5¼" Disk Drive Half-height, direct drive, super quiet. Compatible with all Apple software, and Apple Disk II controller card. Please specify computer II+ or IIe..... **\$69**

5¼" Disk Drive IIc, IIgs..... **\$119**

5¼" disk drive controller card Standard disk controller. Connection for 2 drives. Compatible with Disk II disk drives.... **\$49**

Extended 80 column card with 64K Upgrade your IIe to 128K plus 80 column text display..... **\$69**

ViewMaster 80™ Super resolution 80 column card. Compatible with all 80 column software. Includes software that runs AppleWorks on a II+ or Franklin... **\$109**

Pocket Rocket™ 16K RAM card Upgrade your II or II+ to 64K and run ProDOS..... **\$69**

TransWarp™ Have a large database, spreadsheet, or slow program? This card will run all calculations, searches, alphabetizing 3.6 times faster for the II+ and IIe..... **\$169**

RamWorks Original comes with 512K installed. Expands to 1 MEG with optional 512K RamWorks Expander. Manual and newest AE software included..... **\$169**

More Quality Products

Ultra High-Res RGB Monitor/TV This Sony model KV1311CR RGB monitor features a 13" ultra high-res, Micro black Trinitron tube for super sharp 80 column text and graphics display. Compatible with analog, digital, and composite video. In addition to being the BEST RGB monitor available, it is also a 180 channel cable ready, remote control color TV..... **\$499**

IIe RGB cable (\$29 sep.) w/Sony... **\$19**

IIgs RGB cable (\$29 sep.) w/Sony **\$19**

Kensington System Saver® II+, IIe **\$69**

Kensington System Saver® IIgs... **\$74**

Pinpoint™ AppleWorks™ Accessories Includes RAM Enhancement Kit, Enhanced IIe required..... **\$69**

Pinpoint™ Spell Checker Requires Accessories..... **\$39**

Pinpoint™ Point-to-Point..... **\$78**

MacroWorks..... **\$29**

Super MacroWorks..... **\$39**

Time Out UltraMacros..... **\$40**

Time Out QuickSpell..... **\$45**

VIP Professional™ IIe..... **\$169**

VIP Professional™ gs..... **\$199**

WordPerfect™ (Specify IIc, IIe or IIgs) **\$89**

Sideways™..... **\$46**

Deluxe Paint II™..... **\$74**

Managing Your Money™..... **\$98**

MultiScribe cs™..... **\$64**

Flight Simulator II™..... **\$34**

F-15 Strike Eagle™..... **\$24**

MACH III Joystick for IIc, IIe & IIgs... **\$34**

(10) 5¼ DS/DD disk w/sleeve..... **\$8**

(10) 3½ DS/DD disk..... **\$15**

Why buy from us?

1. Toll free 800 numbers for orders.
2. We almost always ship from OUR stock. Call us before 3 P.M. and it ships today.
3. All memory cards have factory installed and tested RAM chips.
4. We're nice guys that want to help. We want our business to grow because of repeat customers and word of mouth.
5. We handle only the industry's best. We've tested and used all the products we sell.
6. 15 day money back satisfaction guarantee on hardware. If you don't like something, we'll give you your money back. No hassles.
7. We'll support, service and warranty everything we sell.
8. No surcharge is added for charge cards and we won't charge your card until we ship.
9. No sales tax is collected on orders outside Texas.
10. All shipments are insured by us.

Order by mail: Send check or money order to Preferred Computing, P.O. Box 815828, Dallas, TX 75381

Order by phone: 1-800-327-7234 Visa, MasterCard or COD Texas, Hawaii and Alaska 1-214-484-5464

Orders only call 1-800-327-7234

Questions and Customer Service call 1-214-484-5464

Texas residents add 7% sales tax

Prices subject to change without notice

SPEAKING OF GRAPHICS GALLERY

*Six ocean images
from artists with
Apple II computers*

SCENES FROM THE SEA

All of this month's artists drew their inspiration from the sea, bringing us colorful images from under, over, and on the waves. "Wave Birds," "Moray Eel," "Sea Garden," and "Shell" are Dazzle Draw creations; "Perfection" was done with Paintworks; and Dick Davies used a Koala Pad with Micro Illustrator for "Shells."

SHELL, GLENN RIDENOUR, Cincinnati, OH



PERFECTION, VINCENT
BATISTONI, Address Unknown

WAVE BIRDS, RON ST. PIERRE, Kobe, Japan

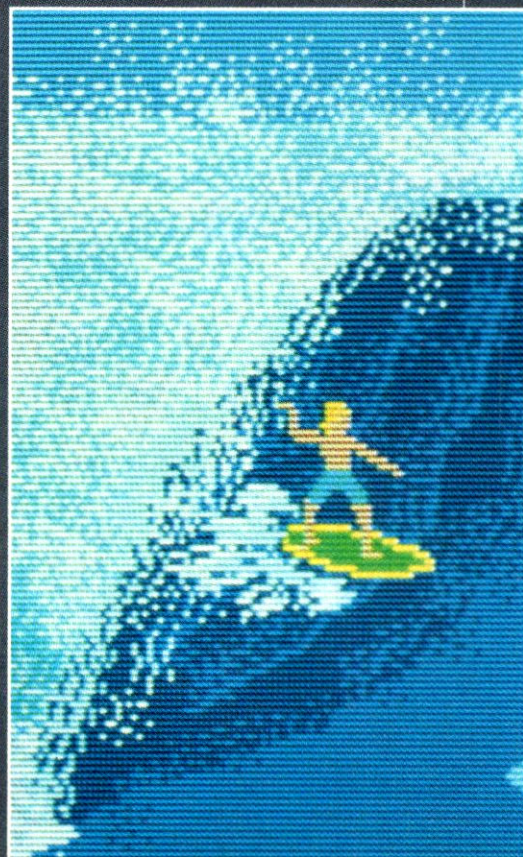

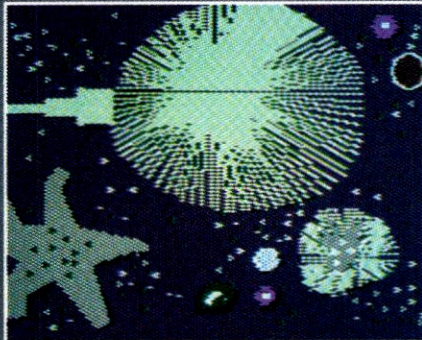
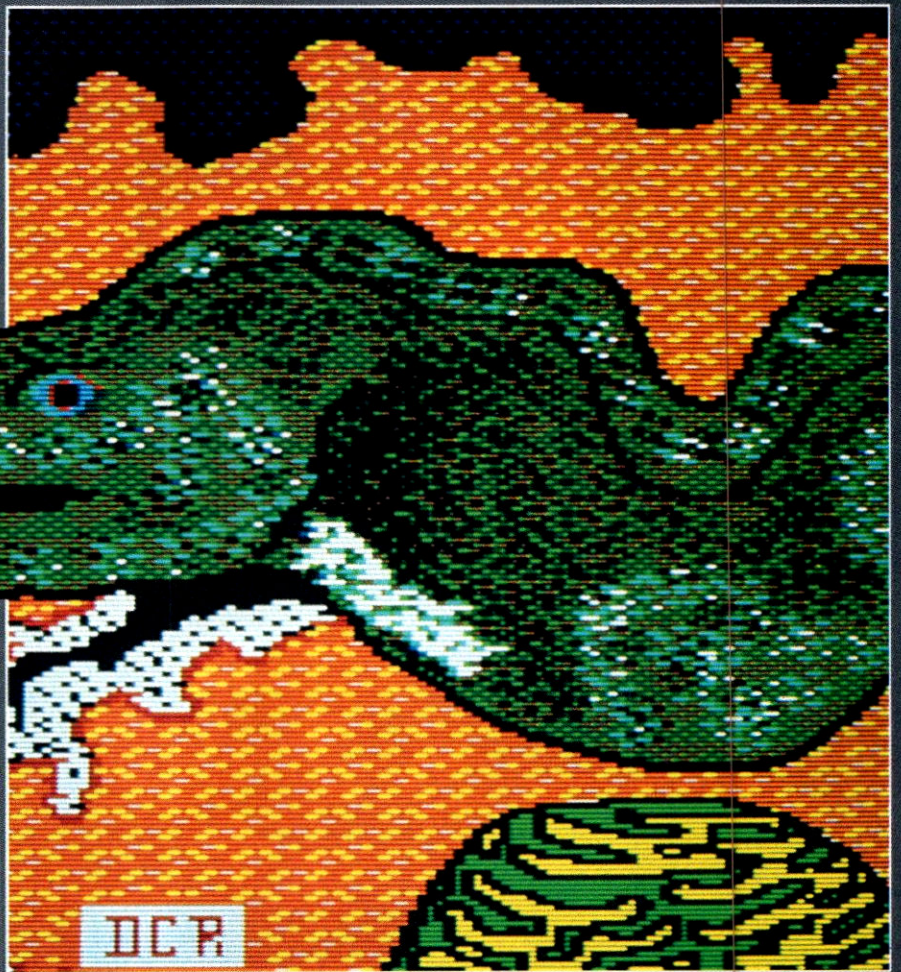

SHELLS, **DICK DAVIES**,
Mountain View, CA

MORAY EEL (above), SEA GARDEN (below), **DAVID RHIND**, *Bermuda*

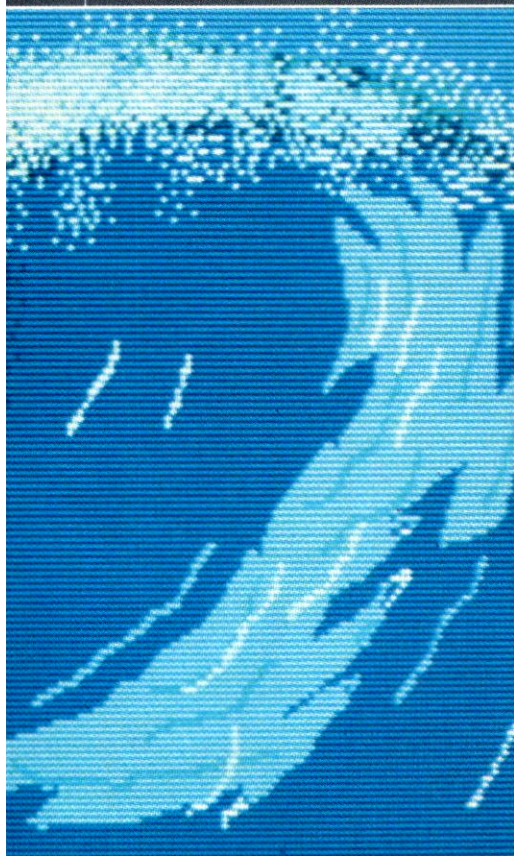

BLAZE YOUR WAY TO GLORY!

WINGS OF FURY



A flame-red dawn streaks the South Pacific skies as your crippled WWII carrier limps for home, enemy planes harassing its every move.

Your F6F Hellcat is the flattop's last battle-worthy plane. Launch yourself into action, armed with bombs, torpedoes, rockets, and blazing machine guns.

Brave a storm of fire as you attack enemy warships and islands. Stay vigilant and ready to outmaneuver their planes in desperate dogfights.

Find out if you have what it takes to earn the most precious wings of all—Wings of Fury.



Use your joystick to maneuver your agile Hellcat as you dogfight, strafe and dive bomb.



Discipline and blind faith will bring you home from a rocket raid against the enemy fleet.

HOW TO ORDER: WINGS OF FURY Apple® 128K IIE, IIG, IIGs, joystick required. \$34.95 Visit your software dealer or call 1-800-527-6263, 8am-5pm PT, for direct credit card orders (VISA, MasterCard, Amex). To order by mail, send check, money order or credit card information to Broderbund Software-Direct, P.O. Box 12947, San Rafael, CA 94913-2947. Californians add 6% sales tax. Add \$3.50 for delivery of one program and \$1.00 for each additional program. Direct orders carry a 10-day money-back guarantee. Allow 4 weeks for delivery.

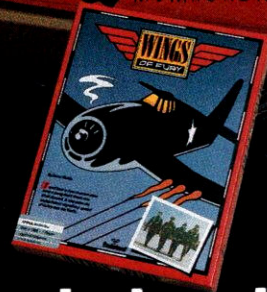

Broderbund®

55MAW

ENTERTAINMENT GAMEPORT

BY BOB LINDSTROM

A preview of eight coming attractions, and a Illes Bard's Tale update

COMING (COMPUTER) ATTRACTIONS

Exploding on the screen in a blaze of glittering pixels, these are the games that demand to be brought before the American public in the first half of 1988: the stories and puzzles that will entertain a nation—arriving soon on your Apple video terminal.

Monster Mash

More deadly than Jaws, more frightening than another "GamePort" literary parody—

joysticks across the nation quiver when monsters go on the Rampage! Leaping from the arcades to your home, three giant fiends—ape, lizard, and wolfman—level as many as 157 cities under your insidious control. Rampage is an Activision production appearing now on Apple IIe/c/Gs computers throughout America (\$34.95).

Put Your Gloves On

He could'a been a contender. Or is he just another punch-drunk pa-

looka from the wrong side of town? The answer lies in your glove in Gamestar's Star Rank Boxing II (\$34.95). He slugs it out against the computer-controlled fighters. He pummels other human opponents. He trains and coaches and fights exhibition matches in his quest for The Title. Just when you thought it was safe to go back into the ring, Star Rank Boxing II—the sequel—hits the mat, boasting better sound, animation, and more fluid player control than the original. Now playing on an Apple near you.

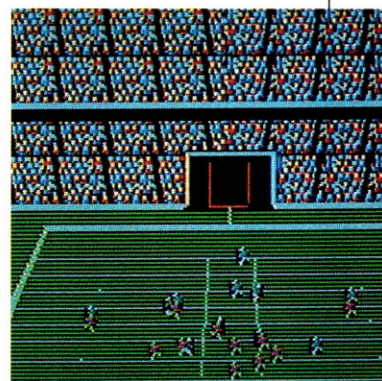
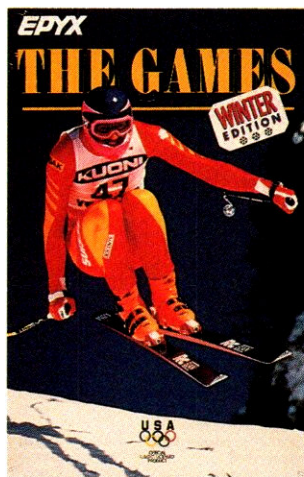
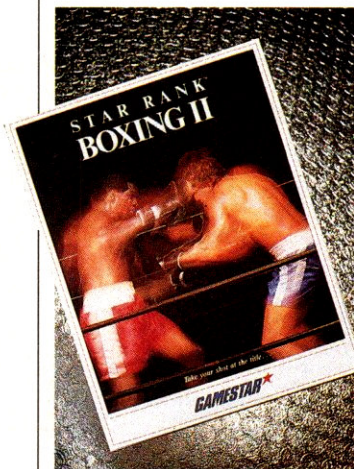

John Madden Football

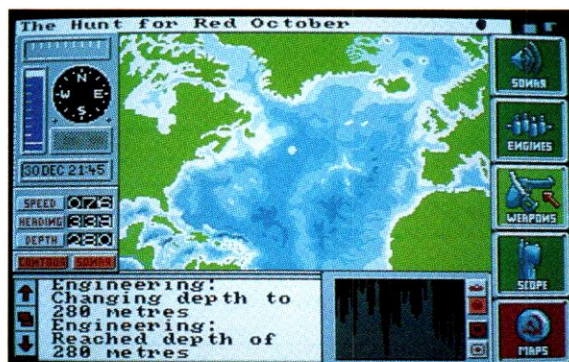

The Hunt for Red October

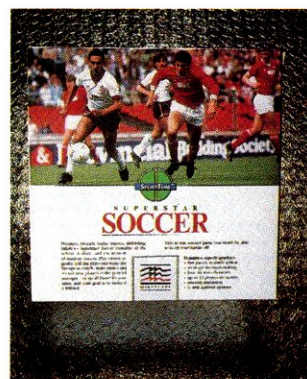
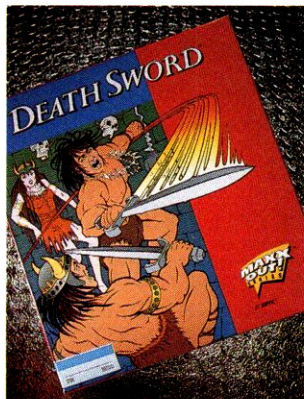

GOLEM COMPUTERS

P.O. BOX 6698 • WESTLAKE VILLAGE, CA 91360

**"If you don't see it
call us - we'll get it"**

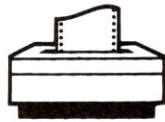
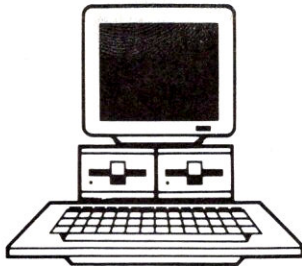

SOFTWARE - HARDWARE - PERIPHERALS AT **DISCOUNT** PRICES

SOFTWARE

ENTERTAINMENT

ACCOLADE Hardball	19.50
Mean 18 (IGS), Hardball (IGS)	ea. 25.00
ACTIVISION	
Shanghai (IGS), Hacker II (IGS)	29.00
Tess Times (IGS), Maniac Menston	ea. 24.00
Hacker II, Shanghai	ea. 24.00
Championship Baseball or Football	ea. 24.00
Championship Basketball (IGS)	ea. 24.00
Gamebreaker, Might & Magic	ea. 31.00
BRODERBUND Airheart, Lode Runner	ea. 22.00
Championship Lode Runner, Karataka	ea. 22.00
Ultima I, III, 2400 A.D.	ea. 26.90
Ultima IV, V	ea. 40.15
ELECTRONIC ARTS Bard's Tale	29.70
Marble Madness (IGS)	24.60
World Tour Golf (IGS)	26.40
Bard's Tale (IGS), Bard's Table II, III	33.00
Chessmaster 2000, Chuck Yeager AFS	ea. 28.40
Legacy of Ancient, Deathlords	ea. 28.40
EPYX World Games, Winter Games	ea. 24.00
World Games (IGS), Winter Games (IGS)	ea. 24.00
Summer Games I or II,	ea. 24.00
Street Sports: Basketball or Baseball	ea. 24.00
Championship Wrestling,	24.00
California Games (Ic/Ic/IGS)	26.40
Destroyer IIe, (IGS)	ea. 26.40
HAYDEN SOFTWARE Sargon III	21.00
INFOCOM Zork Trilogy	44.00
Beyond Zork	33.00
MICROPROSE Silent Service	22.00
F-15 Strike Eagle	22.00
Silent Service (IGS)	26.40
PBI Software (All IGS)	26.40
Sea Strike, Monte Carlo	ea. 24.00
The Tower of Myrarglen	32.00
Cavern Cobra, Strategic Conquest	ea. 30.00
SIERRA ON-LINE King's Quest I, II, III	ea. 31.00
Thexder (IGS)	24.00
King Quest (IGS), Space Quest (IGS)	ea. 31.00
Leisure Suit Larry (IGS)	26.40
SIR-TECH Wizardry	31.00
Knight of Diamonds,	31.00
Legacy of Lylgamin,	31.00
Return of Werda	39.60
Deep Space	26.40
STRATEGIC SIMULATION	
Gettysburg, Warship, Battlecruiser	ea. 39.60
Phantasia I, II, III, Roadwar 2000	ea. 26.40
SUBLOGIC Flight Simulator II,	ea. 32.50
Jet,	ea. 26.40
Scenary Disk 1 thru 6	ea. 14.75

EDUCATION

BARRON'S Study Program For SAT V2.0	32.50
BRODERBUND Science Tool Kit	50.00
Science Tool Kit Module 1, 2, 3	ea. 26.40
Where in the USA is Carmen San Diego	27.40
Where in the World is Carmen San Diego	24.40
DAVIDSON & ASSO. Homeworker	52.00
Math Blaster Plus, Alge-Blaster	ea. 28.00
Read and Roll, Math & Me	ea. 28.00
Word Attack, Spell It, Grammar Gremlins	ea. 28.00
DESIGNWARE Spellcopter, Math Maze	ea. 25.40
Grammar Examiner, States & Traits	ea. 25.40
The Body Transparent, European Nations	ea. 25.40
EDU-WARE Algebra I, II, III, IV	ea. 26.40
Algebra V & VI	33.00
ELECTRONICA ARTS	
Mavis Beacon Teaches Typing (IGS)	29.70
FIRST BYTE (for IGS) (786K Req.)	

Mathtalk, First Shapes, Kidtalk	ea. 32.00
Speller Bee, Smoothtalker	ea. 32.00
Mathtalk Fractions, First Letter & Words	ea. 32.00
GREAT WAVE , Kids Time II (IGS)	26.40
HARDCOURT, BRACE, JOVANOVIH	
Computer Prep for the GRE	59.40
Computer Prep for the ACT,	29.00
Computer Prep for the SAT	26.40
MINDSCAPE Crossword Magic	33.00
RANDOM HOUSE	
Garfield Double Dares, Fix It,	ea. 23.10
SCHOLASTIC	
Storymaker, Storytree, Math Shop	ea. 26.40
SIMON & SCHUSTER Typing Tutor IV	29.15
SPINMAKER Kidwriter	26.40
SPRINGBOARD	
Early Games, Piece of Cake	ea. 23.10
THE LEARNING COMPANY	
Reader Rabbit (IGS)	36.00
Writer Rabbit, Think Quick, Robot	
Odyssey, Rocky's Boots, Gertrudes	
Puzzle (Ile/Ic/IGS)	ea. 29.50
Math Rabbit, Reader Rabbit, Gertrudes	
Secrets, Magic Spells (Ile/Ic/IGS)	ea. 26.40
WEEKLY READER Sticky Bears - ABC's,	
Numbers, Shapes, Opposites, Reading,	
Basics, Typing, Drawing, Music,	
Spellgrabber, Town Builder	ea. 25.00

BUSINESS

BPI (PRODOS runs on IGS)	
General Accounting, AP, AR, Payroll,	
Inventory Control	ea. 131.00
BRODERBUND Bank Street Writer Plus	50.00
On Balance	40.00
Show Off	39.60
DAC SOFTWARE DAC-Easy Accounting	48.00
DATAPAK Graphics Writer (IGS)	85.00
Notes and Files (IGS)	75.00
PBI Visualizer (IGS)	51.45
Visualizer (Ic/Ile)	47.00
PEACHTREE Back to Basics Acct. Sys.	129.00
PINPOINT	
Spellchecker, Document Checker	ea. 37.75
Speller/Document Checker Combo	53.45
Profiler 3.0	66.85
SENSIBLE SOFTWARE Sensible Writer	57.00
Sensible Speller IV (DOS, PRO DOS)	ea. 64.60
Sensible Grammar Checker	57.00
Graphics Department	64.60
SOFTWARE PUBLISHING	
PFS: Graph, Plan (128K PRO DOS)	ea. 65.00
PFS: File & Report (128K PRO DOS)	65.00
PFS: Workmates (128K PRO DOS)	110.00
PFS: Write w/Speller (128K PRO DOS)	65.00
SOFTWOOD Softwood GS File	61.00
SPRINGBOARD Publisher	78.20
STYLEWARE Multiscribe (IGS)	60.40
Font Library (IGS)	26.40
Deskworks (IGS)	36.00
Multiscribe 3.0 (Ile/Ic)	46.20
Font Paks 1-5	ea. 15.00
TIMEWORKS Publish it	66.00
WORDPERFECT	
Wordperfect (IGS), (Ile/Ic)	ea. 83.60

HOME/PERSONAL

ACTIVISION Writer's Choice Elite (IGS)	59.40
Paintworks Plus (IGS)	59.40
Draw Plus (IGS), Music Studio (IGS)	59.40
Paint, Write, Draw Bundle (IGS)	115.00

BAUVILLE 816/Paint (IGS)	39.10
BRODERBUND	
The Print Shop (IGS), Fantavision (IGS)	ea. 37.00
The Print Shop Library (IGS)-	
Sampler, Party	ea. 23.10
The Print Shop	29.15
The Print Shop Library 1, 2, 3	ea. 15.25
ELECTRONICS ART	
Delux Paint II (IGS)	73.00
Arts Part I, II, Seasons & Holidays	ea. 22.00
Delux Print II (IGS)	33.00
Music Construction Set (IGS)	36.00
Instant Music (IGS)	36.00
FUNK SOFTWARE Sideways	45.00
INTUIT Quicken	32.00
MECA Managing Your Money 3.0	88.55
MONOGRAM Dollars & Sense (128K/48K)	ea. 69.85
PINPOINT Micro Cookbook	33.00
Bon Appetit	39.60
ROGER WAGNER The Write Choice	42.90
Mousewriter (Ic/Ile, IGS)	87.45
SPRINGBOARD The Newsroom	36.00
Clip Art Collection 1, 3	ea. 19.80
Clip Art Collection 2	26.40
Certificate Maker	26.40
STYLEWARE Top Draw (IGS)	59.40

UTILITY/LANGUAGE

BEAGLE BROS. Super Macroworks	31.00
Timeout - Superfonts	47.00
Timeout, Quickspell	ea. 43.00
Timeout-Filemaster, Sidespread,	
DeskTools	ea. 31.00
Timeout Ultramacros	35.00
Timeout Graph	52.00
BORLAND Turbo Pascal	46.80
CENTRAL POINT Copy Two Plus	23.00
MICROSOFT Applesoft Compiler	125.00
Fortran Compiler (CP/M)	85.00
PINPOINT Pinpoint Starter Pak (IGS)	83.50
Pinpoint, Graphics Edge	ea. 52.00
Run, Run, Key Player	ea. 28.00
Point to Point	66.80
Infomerge	45.00
Command Com, Tool Kit	ea. 40.00
ROGER WAGNER Merlin 8/16/(PRO DOS)	75.00
Softswitch (IGS)	39.60
TERRAPIN Logo	60.00
TML Pascal (IGS), Basic (IGS)	ea. 82.50
Source Code Library (IGS)	32.00
Speech Toolkit (IGS)	46.20
UNITED SOFTWARE	
ASCII Express (PRO DOS)	70.00
ASCII Express Mousetalk	57.00

HARDWARE

COMPUTERS

CENTRAL POINT	
Laser 128EX	460.00
External Disk Drive (5 1/4")	90.00
External Disk Drive (3 1/2")	185.00
Laser Expansion Box (2 slots)	41.00
Cables - Parallel Serial RGB	ea. 16.00
Amber Monitor	92.00
Mouse	51.00

MEMORY & INTERFACE

APPLIED ENGINEERING	
Ram Factor 256K (II +, Ile, IGS)	180.35

Ram Factor 512K (II +, Ile, IGS)	256.00
Ram Factor 1MB (II +, Ile, IGS)	392.00
Ram Works III 256K (Ile)	165.00
Ram Works III 512K (Ile)	235.00
Ram Works III 1MB (Ile)	341.00
GS-Ram 256K (IGS)	153.00
GS-Ram 512K (IGS)	234.00
GS-Ram 1MB (IGS)	360.00
GS-Ram PLUS 1MB	500.00
Z-Ram Ultra 3 512K + Clock + Z-80 (Ic)	330.00
Z-Ram Ultra 3 1MB + Clock + Z-80 (Ic)	455.00
Trans Warp (II +, Ile)	167.00
Z-80Plus (II +, Ile, IGS)	114.00
Z-80C (Ic)	122.00
Timemaster H.O. (II +, Ile, IGS)	77.00
Phasor (II +, Ile, IGS)	137.50
THIOPRO (II +, Ile, IGS)	117.30
Parallel Pro	77.00
PC Transporter 384K	357.00
PC Transporter 512K	430.00
PC Transporter 768K	465.00
Ramcharger, RamKeeper	137.00
ORANGE MICRO Hotlink (Ic)	46.20
Grapler C/MAC/IGS	66.00
Prograpler (Ile)	74.00
STREET ELECTRONICS Echo Plus	125.00

HARD DISK DRIVES

CMS External w/Controller (Ile, IGS)	
20MB (Stackable)	661.00
40MB (Stackable)	865.00
60MB (Stackable)	985.00

MODEMS

APPLIED ENGINEERING Datalink	170.00
EPIC TECHNOLOGY	
Epic 2400 BPS (Internal)	160.00
PROMETHEUS Promodem 300c (Ic)	82.00
Promodem 1200A	155.00

MONITORS

MITSUBISHI 14" RGB (1409C)	315.00
THOMPSON 14" RGB/Composit (4120)	258.00

ACCESSORIES

BLAND MEDIA (Bulk)	Call
CH PRODUCTS	
Mach III w/fire Button (II +, Ile, IGS)	ea. 34.00
Mach IV (Ile/Ic)	44.00
Flight Stick	50.00
KENSINGTON System Saver	64.00
Turbo Mouse ADB (IGS)	86.80
System Saver IGS	73.00
KOALA TECHNOLOGIES Koala Pad Plus	82.50
KURTA Apple IS/GS Tablet (IGS)	341.00
MOUSE SYSTEMS A + Mouse	74.80
Apple ADB Mouse (IGS)	88.50

PRINTERS

CITIZEN MSP 120D (80 col., 120 cps)	167.00
MSP 180D (80 col., 180 cps, NLQ)	195.00
PANASONIC	
KX 1060I (80 col., 120 cps, NLQ)	184.00
KX-1091I (80 col., 160 cps, NLQ)	210.00
STAR MICRONICS NX-1000	210.00
C. ITOH C310	495.00
SEIKOSHA 1000AP (Imagewriter I)	250.00

FOR CUSTOMER SERVICE CALL 1-805-499-7785

Monday thru Friday 9 a.m. to 5 p.m. - Pacific Time

To order call toll free or send check or money order to the P.O. Box only. VISA/MC orders welcome. Sorry, no C.O.D. Personal and company checks, allow 10 working days to clear. Specify if to back order or to send refund. California residents add 6% sales tax. Include phone number with order. All sales are final. Defective items will be replaced or money refunded, at our discretion. Call for Return Authorization number. We are not responsible for suitability or compatibility. Shipping and handling: All shipments U.P.S. if possible. Continental U.S. - Software: add \$4.00 min., Hardware: add 5% (\$6.00 min). APO, FPO Alaska, Hawaii, Puerto Rico and Canada. Software: add \$8.00 min. Hardware: add 10% (\$10.00 min).

ALL ITEMS SUBJECT TO AVAILABILITY. PRICES AND STIPULATIONS SUBJECT TO CHANGE WITHOUT NOTICE.

1111 Rancho Conejo Blvd. #407

IN CALIFORNIA CALL 1-805-499-0197

Newbury Park, CA 91320

GAMEPORT

Tanked Up

The generals on the hill call the shots, but the men in metal suffer the grinding, the groans, and the gore of tank war. They control the Fire Power (\$24.95, IIGs). Whether pitted against microcomputer or man, they blast buildings and pulverize helicopters in three different kinds of tank. They dig their tracks of death while searching for total control of the enemy outpost. And when these armor-clad messengers of doom can't face one another across the keyboard, they connect modems and carry on combat over telephone lines. Truly, war is heck. A Micro-Illusions production, now at a software store near you.

More Winter Games

They dared the challenge of athletic competition in Epyx's Winter Games. They challenged the daring competition of athletes in Epyx's Summer Games. They competed in daringly athletic challenge in Epyx's California Games and athletically dared to challenge the competition in Epyx's World Games. But now they return to gamely face more games in The Games—Winter Edition (\$39.95, Apple II series). Athletic challengers from around the world gather in Calgary, Alberta to test their daring in speed skating, downhill skiing, slalom, luge, ski jump, figure skating, and cross-country skiing. Sactioned by the U.S. Olym-

One thing is sure. Heads will roll when warriors wield the Death Sword, an epic of hand-to-hand arcade combat coming soon for the II.

pic Committee, The Games—Winter Edition revives the daring spirit of international athletic competition for up to eight players. Coming soon from Epyx.

The Baddest Wins

Visit an earlier, more primitive time, ruled by rippling muscles and primitive emotions. A heroic barbarian pits his strength against evil gladiatorial might. Two bloodthirsty fighters face off in a battle to the death.

The hero's prize? A gossamer-veiled princess and the death of the dreaded sorcerer Drax. Each heroic victory brings another, more powerful opponent. One thing is sure. Heads will roll when warriors wield the Death Sword (\$24.95), an epic of hand-to-hand arcade combat coming soon from Epyx for the Apple II series.

Superstar Soccer

Share the turf with a bunch of wacky guys who just want to score. Kick up a storm in Superstar Soccer, a complete

Serial Pro® The intelligent multifunction card from Applied Engineering.

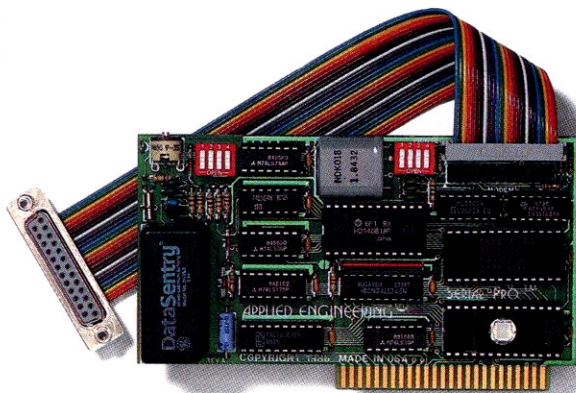

Serial Pro is a powerful multifunction card for the Apple IIe, II+, IIGs and compatible computers. Serial Pro combines a powerful serial port for interfacing to a printer, modem or other serial device, with a full function clock/calendar. Serial Pro's serial port is compatible with virtually all letter quality and dot matrix printers, including Apple's Imagewriter and Imagewriter II, and can communicate with the fastest external modems at baud rates from 50 to 19,200.

Set up is easy, because unlike other cards, there are no switches to program serial parameters or disks to use. Serial Pro has a built-in setup screen that allows all parameters to be set. And on-screen help that makes it super-easy. An on-board battery stores your selections for over 20 years, but you can change them at any time. Serial Pro is the perfect upgrade for Super Serial card owners looking for more performance or a built-in clock.

Serial Port Features

- Fully Super Serial Card compatible but more versatile and easier to use
- Compatible with printers
- Compatible with modems
- Prints graphics to printer (without software) in normal mode, 90° rotation, double size, side by side, and black/white inversion
- Variable word length, number of stop bits and parity selection
- Crystal controlled circuits are used to provide ultra accurate baud rates.

Clock Calendar Features

- ProDos, DOS and AppleWorks compatible. Displays time and date on the AppleWorks screen
- Automatically time and date stamps AppleWorks files
- 20 year auto recharging nickel-cadmium battery
- Realtime interrupts
- Built-in on screen time and date settings (no software needed)
- Does not use phantom slots.

Serial Pro is perfect for Apple IIe, II+, IIGs or compatible owners in need of a serial port or clock/calendar or both. But unlike other multifunction cards on the market, Serial Pro does not use phantom slots, so all the slots in your computer are useable.

Serial Pro comes complete with manual, cable and instructions for connecting to all the leading printers and modems.

Serial Pro \$139

Order Today! See your dealer or call Applied Engineering, 9 a.m. to 11 p.m. 7 days. Or send check or money order to Applied Engineering. MasterCard, VISA and C.O.D. welcome. Texas residents add 5½% sales tax. Add \$10.00 outside U.S.A.

AE APPLIED ENGINEERING™

The Apple enhancement experts

(214) 241-6060

P.O. Box 798, Carrollton, TX 75006

ZIPCHIP™

THE FASTEST - 400% FASTER!!!

APPLEWORKS
USERS READ THIS

ZIP CHIP IS A TECHNOLOGICAL BREAKTHROUGH in Apple II speed enhancement; a new microprocessor replacement for your original CPU, running at 4 megahertz speed, four times faster than the original Apple II speed of 1 megahertz.

Can you imagine the time you'll save having your **Apple II+, IIe, or IIc**, running **400% faster**. No waiting for the machine to catch up with your own thinking speed. AppleWorks just flying, processing data, crunching numbers; Print Shop simply running at the speed of the printer. ZIP CHIP DELIVERS!

ZIP CHIP™

- Requires no special tools or knowledge to install.
- Is very easy to operate.
- Occupies no slot.
- Has no switches.
- Needs no special boot-up.
- Provides IBM PC/AT speeds from an Apple II.
- Is compatible with all Apple hardware.
- Runs all Apple software.
- Uses 1/7th the power of competing boards.
- Addresses all memory.
- Speeds up the first 2 megabytes of memory.
- Speeds up all types of memory, Main, ROM, & Aux.
- Operates at 4 megahertz, 400% faster.
- Runs at 20 variable speeds.
- Controls speed changes by keyboard/software.
- Will never wear out or breakdown.
- Is faster than any speed-up board.
- Costs much less than any speed-up board.
- Offers a FREE 30 Day Trial Period.
- Carries a LIFETIME Warranty.
- Provides a MONEY BACK Guarantee.

HERE'S HOW IT WORKS

ZIP CHIP contains a fast 65C02 microprocessor, a unique gate array and a special 16K RAM for cache, which allows data and instructions to flow through your Apple II at an accelerated rate without causing a jam-up. Since the normal speed of the 65C02 CPU is only 1 megahertz, the ZIP Technology engineers replaced the normal clock with an internal 16 megahertz crystal and partitioned it such that the enhanced ZIP CHIP will operate at 4 megahertz, a 400% increase in speed.

LIFETIME WARRANTY

ZIP CHIP carries a LIFETIME REPLACEMENT WARRANTY for registered owners. If, for any reason, its internal circuitry fails to function, just return it for a FREE replacement; forever, anytime, for whatever reason.

Apple, Apple II, AppleWorks are trademarks of Apple Computer Inc.
Print Shop is a trademark of Broderbund
IBM PC/AT is a trademark of IBM
Zip Chip is a trademark of Zip Technology
Patent Pending

CIRCLE 102 ON READER SERVICE CARD

TRIAL OFFER/MONEY-BACK GUARANTEE

ORDER YOUR ZIP CHIP TODAY and you will also receive a valuable diskette containing a complete diagnostic test program that will put your Apple II through over 309 million separate byte tests. You will also receive a separate Apple memory tester program — plus a ZIP configuration program, and two start-up programs.

Normally a \$40.00 value, its yours **FREE** for just trying ZIP CHIP. Use ZIP CHIP in your own machine for **30 days**. If it doesn't perform to your satisfaction, return it for your money back and you keep the \$40.00 diskette; our **FREE** gift for trying ZIP CHIP.

TO ORDER

ZIP CHIP and your FREE diskette are available directly from Zip Technology. Priced at just \$179.00 retail, during this Introductory Offer ZIP CHIP is still only \$129.00, a savings of \$50.00. Just add \$4.00 for Shipping, Handling and Insurance, for a total of only \$133.00. (California residents please add \$8.39 sales tax for a total of only \$141.39). Checks, VISA, MasterCard, and American Express accepted. Write to:

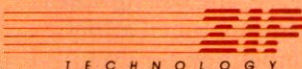

Dept. A5
11340 West Olympic Blvd.
Los Angeles, CA 90064

FOR FASTER ORDERING AND DELIVERY,
CALL TODAY TOLL-FREE

1-800-922-3700



SILICON EXPRESS DISKS
SS/DD 6.95
DS/DD 7.95

VERBATIM OR MAXELL
SS/DD 13.95
DS/DD 16.95

YOUR TOLL FREE ACCESS CALL...FOR THE BEST PRICES...BEST DELIVERY
1-800-999-6868
We have hundreds of other programs in stock at Fantastic savings.

SILICON EXPRESS

LASER 128 EX—APPLE COMPATIBLE COMPUTER \$449.95

- | | | | | | |
|--|---------------------------------|------------------------------|-----------------------------|----------------------------|------------------------------|
| ACT (Harcourt) 29.95 | Deluxe Paint IIGS 69.95 | Magic Spells 24.95 | Rocky Horror Show 13.95 | Temple of Apsai Tri. 13.95 | Disk Notcher 4.95 |
| Adventure Const. 11.95 | Desk Accessories 27.95 | Man. Your Money 99.95 | Robot Odyssey I 29.95 | Terrapin Logo 59.95 | Disk Drive Controller 46.95 |
| Airheart 22.95 | Destroyer 26.95 | Master Type 23.95 | Rocky's Boots 29.95 | Terrapin Utilities 13.95 | Disk Drive American 129.95 |
| Algeblaster 28.95 | DiskQuick 19.95 | Math & Me 24.95 | Run Run 29.95 | Think Quick 34.95 | Essential Data Dup 4+ CALL |
| Alphabet Zoo 18.95 | Dragonworld 10.95 | Math Blaster + 29.95 | Sargon III 13.95 | Think Tank 89.95 | Fingerprint Plus 88.95 |
| Alpha Plot 20.95 | Draw Plus IIGS 62.95 | Math Rabbit 24.95 | Sat (Harcort Brace) 24.95 | Timeouts 49.95 | Flight Stick 51.95 |
| American Challenge 24.95 | Early Games 20.95 | Megaworks 48.95 | Science Tool Kit 52.95 | Timeout Desktools 32.95 | Gibson Lightpen CALL |
| Animate 42.95 | Easy as ABC 23.95 | Merlin 39.95 | Sensible Grammar 54.95 | Timeout Filemaster 32.95 | Grappler Buf. (16K) 114.95 |
| Architectural Design 71.95 | Eidolon 9.95 | Merlin 8/16 88.95 | Sensible Speller 69.95 | Timeout Sidespread 32.95 | Grappler Pro 79.95 |
| Archon II 11.95 | 816 Paint 52.95 | Merlin Combo 67.95 | Sensible Writer 59.95 | Timeout Superfonts 52.95 | Grappler (serial) 73.95 |
| ASC II Express 73.95 | Essential Data Dup 4 19.95 | Micro Cookbook 26.95 | Shanghai 24.95 | Timeout Ultramacros 39.95 | Grappler C Mac IIGS 73.95 |
| Assembly Lines Bk. Auto Duel 32.95 | Europe Ablaze 32.95 | Micro Lg. Baseball 23.95 | Shape Mechanic 26.95 | Tip Disk #1 13.95 | GS-Ram 256K CALL |
| Award Maker Plus 27.95 | Extra K 26.95 | Micro Lg. Manager 23.95 | Sharp of Spring 27.95 | Top Draw 62.95 | GS-Ram 512K CALL |
| Bag of Tricks #2 28.95 | F-15 Strike Eagle 20.95 | Micro Lg. Team Disk 13.95 | Sideways Pro Dos 41.95 | Toy Shop 32.95 | GS-Ram 1 MEG CALL |
| Balance of Power 34.95 | Facemaker 26.95 | Might & Magic 34.95 | Silent Service 20.95 | Transylvania 11.95 | GS Ram 1 1/2 MEG CALL |
| Ball Blazer 9.95 | Family Roots 149.95 | Millionaire II 39.95 | Silicon Salad 20.95 | Trinity 24.95 | GStero 34.95 |
| Ballyhoo 19.95 | Fantavision 29.95 | Minipix 1, 2 or 3 19.95 | Skyfox 11.95 | Triple-Dump 26.95 | Hotlink 44.95 |
| Bank Street Filer 39.95 | Fat Cat 22.95 | Missing Links 31.95 | Smart Money 34.95 | Turbo Pascal 3.0 44.95 | Juice Box 67.95 |
| Bank Street Mailer 39.95 | Financial Cookbook 10.95 | Moebius 39.95 | Soft Switch 34.95 | Turbo Database Tltx 45.95 | Koala Pad + 77.95 |
| Bank Street Music 34.95 | Fleet System III 39.95 | Mouse Mist 24.95 | Solo Flight 20.95 | Turbo Tutor 21.95 | Kraft 2 Button 27.95 |
| Bank St. Writer Plus 49.95 | Flight Sim. II 32.95 | Mouse Talk 58.95 | Speed Reader II 41.95 | Tycoon 20.95 | Kraft 3 Button 34.95 |
| Bank Street Speller 39.95 | Flight Scenery 64.95 | MouseWrite 87.95 | Spellcopter 24.95 | Type! 28.95 | Laser 128 Computer 378.95 |
| Bard's Tale 29.95 | Fntpaks 1 thru 13 ea. 17.95 | Multiplan DOS 3.3 69.95 | Spell It 29.95 | Typing Tutor IV 30.95 | Laser 128 EX 449.95 |
| Bard's Tale II 31.95 | Font Mechanics 19.95 | Multiscribe 3.0 54.95 | Spin Dizzy 10.95 | Ultima III 27.95 | Laser Disk Drive 88.95 |
| Baron 30.95 | Fraction Factory 17.95 | Multiscribe GS 3.0 64.95 | Springboard Publisher 94.95 | Ultima IV 39.95 | Laser Mouse 58.95 |
| Beagle Bag 19.95 | Fraction Fever 17.95 | Multiscribe Fonts 13.95 | Squire 31.95 | Understanding IIE 17.95 | Lemon 26.95 |
| Beagle Basic 22.95 | Game Maker 32.95 | Munch-A-Bug 23.95 | Star Fleet I 33.95 | Utility City 19.95 | Mach II Joystick 26.95 |
| Beagle Compiler 49.95 | Gato 24.95 | Music Construction 11.95 | Star Trek I or II 25.95 | Video Toolbox 23.95 | Mach III Joystick 34.95 |
| Beagle Graphics 39.95 | Gertrude's Puzzles 27.95 | Nam 24.95 | Sticky Bear ABC 22.95 | V.I.P. Professional 164.95 | Mach IV Joystick 49.95 |
| Beagle Screens 22.95 | Gertrude's Secrets 27.95 | NATO Commander 30.95 | Basic 22.95 | Visible 6502 39.95 | Micromodem IIE 153.95 |
| Bnth. Apple Pro DOS 12.95 | Ghostbusters 10.95 | Nord & Bert 27.95 | Basket Bounce 22.95 | Visualizer IIGS 64.95 | No Slot Clock 49.95 |
| Big U 22.95 | GI Joe 13.95 | Ogre 21.95 | BOP 22.95 | Webster Spell Chkr. 27.95 | Paddlesticks 29.95 |
| Blazing paddles 24.95 | GLE 32.95 | On Balance 39.95 | Car Builder 22.95 | Whitehead Chess 44.95 | Parallel Printer Card 44.95 |
| Blue Powder 34.95 | Grafx Pro 18.95 | One-On-One 11.95 | Drawing 22.95 | Wilderness 22.95 | Power Supply 59.95 |
| Bookends 69.95 | Grammar Gremlins 28.95 | Paintworks 62.95 | Math Word Problems 22.95 | Will Writer 29.95 | Print-It 122.95 |
| Bookends Extended 84.95 | Graphics Department 69.95 | PFS: File & Report 69.95 | Music 22.95 | Winter Games 13.95 | Ram Factor 256K CALL |
| Bob & Wrestle 27.95 | Graphics Expander 23.95 | PFS: Graph 69.95 | Math 1 or 2 22.95 | Wizard 10.95 | Ram Factor 512K CALL |
| Breakers 26.95 | Graphics Magician 25.95 | PFS: Workmates 148.95 | Numbers 22.95 | Wizard's Toolbox 23.95 | Ram Factor 1 Meg CALL |
| Bureaucracy 26.95 | Graphics Scrapbook 16.95 | PFS: Write 69.95 | Opposites 22.95 | Wizprint 15.95 | Ramworks 64K CALL |
| Bus. works Bundle 394.95 | Hacker or Hacker II 24.95 | Piece of Cake Math 20.95 | Parts of Speech 22.95 | Word Attack 29.95 | Ramworks 256K CALL |
| Bus. works Payroll 154.95 | Handlers Package 69.95 | Picture Manager 27.95 | Printer 22.95 | Word Handler 36.95 | Ramworks 512K CALL |
| Cad Apple 69.95 | High Sea 34.95 | Pinball Construction 11.95 | Reading 22.95 | Word Juggler 88.95 | Ramworks 1 Meg CALL |
| California Games 27.95 | High Stakes 24.95 | Pinpoint 49.95 | Rd. Comprehension 22.95 | Word Perfect 88.95 | Ram Keeper 139.95 |
| Carmen Sandiego USA 28.95 | Hitchhiker's Guide 10.95 | Pinpoint Spell Chkr. 43.95 | Shapes 22.95 | Word Perfect GS 88.95 | Super Serial Card 84.95 |
| Carmen Sandiego World 27.95 | Homeword + 43.95 | Pinpoint Toolkit 27.95 | Spellgraber 22.95 | World's Great. Bball 13.95 | System Saver Fan 60.95 |
| Certificate Maker Library Vol. 1 20.95 | Homeworker 34.95 | Point-to-Point 68.95 | Town Builder 22.95 | World's Great. Ftbl 34.95 | System Saver IIGS 79.95 |
| Chshp. Load Runner 19.95 | Infiltrator 19.95 | Pond 31.95 | Typing 22.95 | Writer Rabbit 41.95 | System Saver American 149.95 |
| Chart 'n Graph Tltx. 23.95 | Infomerge 47.95 | Power Print 26.95 | Word Problems 22.95 | Writer's Choice 62.95 | Univ. Disk Controller 79.95 |
| Chessmaster 2000 27.95 | Instant Art 20.95 | Printermate 44.95 | Story Maker 27.95 | Zork Trilogy 34.95 | |
| Chopflifer 10.95 | Interior Design 52.95 | Printographer 24.95 | Sub Battle 27.95 | | |
| Clan Accountant 54.95 | I.O. Silver 16.95 | Printmaster Plus 34.95 | Sum. Games I or II 13.95 | | |
| Classmates 28.95 | Jet 28.95 | Print Quick 34.95 | Super Huey 20.95 | | |
| Clip Art Vol. 1 or 3 19.95 | Karateka 21.95 | Printshop 44.95 | Super Macroworks 32.95 | | |
| Clip Art Vol. 2 23.95 | Key Player 30.95 | Print Shop Gs 42.95 | Take 1 34.95 | | |
| Commworks 57.95 | Kid Writer 24.95 | Print Shop Holiday 14.95 | Take 1 34.95 | | |
| Complete Graphics 25.95 | Kids on Keys 17.95 | Pr. Shp. Gr. #1,2 or 3 14.95 | Tass Times 24.95 | | |
| Compuserve Starter 21.95 | Kinder Comp 27.95 | Print Shp. Companion 23.95 | | | |
| Conflict in Vietnam 24.95 | Knight of Diamonds 34.95 | Print Shop Refill 11.95 | | | |
| Copy II + 21.95 | King's Quest I, II or III 29.95 | Probyter 22.95 | | | |
| Create a Calendar 20.95 | Koronis Rift 19.95 | Profiler 3.0 89.95 | | | |
| Create with Garfield 20.95 | Landscape Design 52.95 | Program Writer 32.95 | | | |
| Crimson Crown 11.95 | Leather Goddess 25.95 | Pronto DOS 19.95 | | | |
| Crossword Magic 31.95 | Leisure Larry 27.95 | Pro Team 79.95 | | | |
| Crusade in Europe 23.95 | Legacy of Lylgamyn 32.95 | Publish It 69.95 | | | |
| D Code 26.95 | List Handler 39.95 | Quicken 33.95 | | | |
| Database Toolbox 23.95 | Locksmith 38.95 | Ram-Up 32.95 | | | |
| Dazzle Draw 36.95 | Lode Runner 21.95 | Reach for the Stars 31.95 | | | |
| Decision in Desert 27.95 | Macroworks 22.95 | Read and Roll 28.95 | | | |
| | | Reader Rabbit 23.95 | | | |
| | | Report Card 34.95 | | | |
| | | Report Works 49.95 | | | |
| | | Rescue on Fractalus 6.95 | | | |
| | | Road Race 10.95 | | | |

SILICON EXPRESS
5955 E. Main St. Columbus, Ohio 43213

Name _____

Address _____

City _____ State _____ Zip _____

Charge # _____ Exp. Date _____

QTY.	DESCRIPTION	PRICE

Computer Type _____ SHIPPING _____

Phone No. _____ TOTAL _____

SILICON EXPRESS
5955 E. Main St. Columbus, Ohio 43213
1-614-868-6868

Add \$3.50 min. U.S. shipping, C.O.D. \$5.00 extra. Hawaii and Alaska \$5.95 min. Orders outside U.S. are not insured. Canada & Mexico 10% min. \$10.00. All other countries 30% min. \$30.00. MasterCard, Visa and school purchase orders accepted. Personal checks allow 3 weeks. 5.5% sales tax for Ohio residents. Defective replaced within 20 days. 20% restocking fee if not replaced with same item. Compatibility not guaranteed. Prices subject to change without notice.

GAMEPORT

His scheme is to surrender his sub to the Yanks without raising the suspicions of his 113-man crew. Can he do it? Can you?

defector. Commander of a state-of-the-art Russian submarine. His scheme is to surrender his sub to the Yanks without raising the suspicions of his 113-man crew. Can he do it? Can he evade detection? Can he learn to control screen after screen of sophisticated submarine equipment? Can you? The answer comes later this year when DataSoft brings The Hunt for Red October to Apple II computers (\$39.95).

There they are, preview fans, just a few of the entertainments that will be lighting up the Apple screen in the weeks and months ahead.

MORE SAD SONGS FROM THE BARD

Adventurer Matthew D. Krantz of Massillon, Ohio, is a woeful participant in one of the greatest adventures of them all, surviving the Apple IIGs.

Krantz discovered, along with many other

"GamePort" combaters, that the Apple IIGs version of The Bard's Tale doesn't work properly.

Well, that's almost true.

The Bard's Tale for the IIGs did work properly once upon a time. But it seems that not so long ago in the temple of Sculley, a hardware wizard from the land of Woz re-designed the ROM (read-only memory) chips in his magical IIGs sound and graphics box.

Worshippers of the IIGs from far and wide took their own boxes to local Apple gurus to upgrade them to the new ROMs.

Unfortunately, the improved ROMs drained much of the enchantment from the originally published version of The Bard's Tale.

Before Bard adventurers around the uncivilized world began casting Shock-Sphere spells in the direction of San Mateo, California, Electronic Arts assembled its own team of wizards to re-write The Bard's Tale to benefit from the new ROMs.

The good news for Matthew and all other IIGs bard beaters is that now they can get the updated version of The Bard's Tale for the IIGs by sending their original disk, along with a note explaining the problem, to:

Customer Warranty
Department
Electronic Arts
1820 Gateway Drive
San Mateo, CA 94404 +

The first clock card to add time and date to AppleWorks™ screens and files.

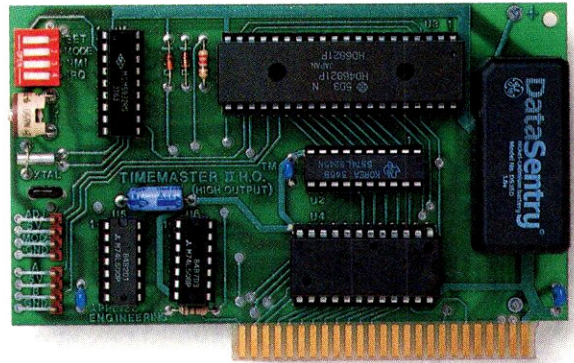

Timemaster H.O. So many features it's become the world's best selling clock card.

It's the smart way to put the time and date on your Apple IIe® or II+®. Because only the Timemaster H.O. packs ALL the important features of all the competition combined, including leap year, year (not just in PRO-DOS), month, date, day of week, hours, minutes, seconds and milliseconds. It's totally PRO-DOS, DOS 3.3, PASCAL and CP/M compatible. And, of course, it works better than any other clock with AppleWorks.

With the Timemaster H.O. you're assured of reliable, trouble-free operation along with simple, built-in, one-command time setting, accuracy through leap years, and a firmware maintained interrupt setting.

If you're using or writing software for other clock cards, you're still covered. Because the H.O. will automatically emulate them. And only the Timemaster H.O. adds 15 new commands to BASIC. The H.O. even comes complete with two disks full of sample programs, including a computerized appointment book, a DOS dating program, interrupt programs, and over 30 programs that others charge you extra for — or don't even offer. As a low-cost option, you can add true BSR remote control to the H.O., giving you remote control of up to 16 lights and appliances in your home or office.

- Time in hours, minutes, seconds and milliseconds; date with year, month, day of week and leap year
- 24-hour military format or 12-hour AM/PM format
- Eight software controlled interrupts so you can run two programs at the same time (many examples included)
- Can be set precisely to the exact second
- Digital I/O port for advanced applications
- Allows AppleWorks to time and date stamp all data automatically
- Displays time and date on AppleWorks screens and files
- Five-year warranty

Timemaster H.O. \$99.00
BSR option (may be added later) \$29.00

Order Timemaster today ... with 15-day money back guarantee and our "no hassle" five-year warranty. See your dealer or call (214) 241-6060, 9 a.m. to 11 p.m., 7 days, or send check or money order to Applied Engineering. MasterCard, Visa and C.O.D. welcome. Texas residents add 6¼% sales tax. Add \$10.00 if outside U.S.A.

AE Applied Engineering
The Apple enhancement experts.

P. O. Box 798, Carrollton, TX 75006 (214) 241-6060

CP/M is a registered trademark of Digital Research, Inc.

ENTERTAIN

A view from a Hellcat's cockpit, a mapmakers' paradise, and Anglophilic trivia await you in this month's games.

HELLCATS OF THE PACIFIC

The Grumman Hellcat was one of the great fighter planes of the War in the Pacific. Between 1942 and 1945, 12,272 of these sturdy aircraft were built for the U.S. Navy, the Marines, and the British Royal Navy. Armed with six 50-caliber machine guns and as much as a ton of bombs, it was equally effective against enemy aircraft and ground targets.

Wings of Fury by Steve Waldo, an action/arcade game, recreates the challenge and excitement of piloting a Hellcat. It is no flight simulator—the joystick controls are quite

simple, the gauges and indicators are nothing like those of the real aircraft, and your airspace is a scrolling two-dimensional screen, with a small window that shows the view from your cockpit. The fast, colorful animation and special effects are up to the very high standards that Apple II gamers have come to expect from Broderbund. Some of the tactics and elements of mission planning are realistic, but the designer has taken a few liberties with history. You can select bombs, rockets, or torpedoes before you take off. The Hellcat, however, never carried torpedoes; that was a job for slow, steady, and specialized bombers.

A good arcade game is quick to learn, visually intense, and full of new challenges as you improve your skill. Wings of Fury gets high marks on all three counts. In the first ten games I played, my score climbed from a pathetic 150 points to a respectable 925. You earn points for knocking out enemy targets. The game

has seven levels of difficulty, but until you get the knack of making carrier landings, you should stay at the beginners' rank ("midshipman"). As in real life, a carrier landing in Wings of Fury is one of the most difficult piloting skills. A little too high and you overshoot the deck. A little too low and you crash into the ship. Crash landings are superbly animated—your plane skids across the deck, spins around, belches smoke, and then bursts into flames.

Air-to-air tactics are extremely challenging. The enemy planes are fast, maneuverable, and quite "intelligent." I haven't been able to line up a good shot against one yet, but I'm still trying, which is some indication of the staying power of this game.

You have three aircraft to complete a mission. The game is over when all three have crashed or been shot down. If you can manage a safe landing on your carrier, you can have your plane rearmed and refueled for another flight. You receive an additional plane every time you earn a promotion in rank.

The game handles the effects of altitude cleverly. At low altitude, you have a detailed view of a small area that scrolls past very swiftly. At high altitude, the view changes to a wide-angle field that moves more



MENTAL REVIEWS



slowly. At low altitude, your bombing and strafing are more accurate, but you are also more vulnerable to anti-aircraft fire.

Although the sound effects are nothing special, the graphics deserve a color monitor. Your carrier rocks gently on the waves, its flag streaming in the wind. Your landing-signal officer waves a pair of little flags. When your tail hook hits the arresting wire, you see the wire reeling out, and when you taxi onto the deck elevator, you see your plane descend into the hangar deck. When you hit an enemy gun position, little animated figures run out, and you can get extra points for strafing them.

The game takes up both sides of a 5¼-inch disk. A self-running demonstration on side A gives prospective players a good idea of the action. A 16-page users' guide provides minimal in-

structions. A few more notes on tactics and a little more historical background would improve the documentation.

Nevertheless, *Wings of Fury* is an engaging entertainment for anyone interested in World War II aerial combat, and a remarkable example of what can be done with 128K on an Apple II.

Mike Markowitz

WINGS OF FURY

Broderbund
17 Paul Drive
San Rafael, CA 94903-2101
(415) 492-3500

LIST PRICE: \$34.95

REQUIRES: Apple IIe (enhanced), IIc, or IIgs; 128K RAM, one 5¼-inch disk drive, joystick. Copy-protected.



SLOGGING THROUGH A MERCENARY WORLD

Like a modern mystery story, *Legacy of the Ancients* involves more legwork than guesswork.

The clues aren't hidden; they're just out of reach. If you run out of ideas, a fortune-teller will give you a hint, and it won't cost you much.

That's not true about anything else in the mercenary world of Tarmalon. Even the ancients who built the Galactic Museum left coin-operated exhibits. So the first priority is building your hoard of gold, which you can do by gambling, borrowing, or stealing it, or by killing wilderness creatures.

No gold, no food—and as you slog your way through the hostile wilderness, food goes fast. So do hit points, unless you've bought weapons and armor to protect yourself from the many



When the Bard's scared sober, trust a thief

... like me.



hen the Bard's Tale began, we lived a charmed life. Good ale. Good song. Good company.

Mangar came along, but we cut him to pieces before he could blink. Soon the world got bigger, and its problems got bigger. We wandered the wilderness for months to find the pieces of that infernal Destiny Wand. But once we reformed it, Lagoth Zanta was history.

Back then, being a thief was dull. Pick this lock. Disarm that trap. When things got hot, they'd tell me "Into the shadows, wimp!" I should've lifted their gold and split long ago. But it's too late now.

We battle through the seven worlds. Cast Warstrike and Rimefang over and over. Cut down the endless Hookfangs and Slathbeasts. And suddenly, The Archmage is powerless. The Warrior is weak. The Bard can't play. Now they say I'm the only hope. I'm slick. I'm sneaky. And I'm going to fight the Mad God... alone.

Some fate.

THE BARD'S TALE™ III THIEF OF FATE™

3 WAYS TO ORDER:

- 1) Visit your retailer.
- 2) Call 800-245-4525 from U.S. or Canada, 8am to 5pm PST, to order by VISA/MC.
- 3) Mail check (U.S. \$) or VISA/MC #, cardholder name, and exp. date to Electronic Arts Direct Sales, P.O. Box 7530, San Mateo, CA 94403. Apple II version \$49.95, plus \$3 shipping/handling. CA residents add 6.5% sales tax. Allow 1-3 weeks for U.S. delivery.



Over 500 colorful, animated kinds of monsters want to meet you. Some might even join your party.



New auto-map feature lets you find your way in the 84 dungeon levels and seven dimensions. No copy protection to slow you down. Save the game at any location.



Your stats show you're hot at lock picking, trap disarming... and hiding. Need more help than that? Seven kinds of spellcasters—including new Chronomancers and Geomancers—cast over 100 spells.

FREE CLUES

See participating retailers for full-color clue poster.



ELECTRONIC ARTS®

REVIEWS

wilderness pests. Rafts and climbing gear cost plenty.

So do magic spells, which you'll need to get past the castle guards—or to the bottom of the dungeon, with its ferocious collection of monsters: gnasher turtles, nerve streakers, and the awful Knuckles.

Why bother? Because the Compendium must be destroyed. You had it once, but some bandits stole it ("it was bound to happen," the game assures you). The Compendium contains the combined magic of many evil wizards, and only the "four jewels" can thwart it.

Your quest begins in the Galactic Museum. Return there often for gold, weapons, clues, and transportation to faraway places. If the curator is pleased with your progress, he'll raise you a level—but he's not easy to please.

The animation is remarkable, especially in the museum and the dungeon. The mazes are three-dimensional; passageways actually move closer or further away as you take each (resounding) footstep. Dungeon monsters loom and attack from all sides, sometimes in layers. Zap one of the monsters with a "kill flash" or try to rob one of the museum exhibits, and you'll be treated to extra fireworks.

In the wilderness, towns, and castle, the graphics become two-dimensional, but move-

ment, with arrow keys and multiple-choice commands, is still fast and realistic. When you get tired of bashing monsters, you can play one of the "action games": blackjack, flip-flop, or point-and-shoot practice at one of the training schools.

Legacy of the Ancients isn't a tricky game, just a hard one. It requires careful notes and patient strategy. The designers, Chuck and John Dougherty, have combined their specialties (psychology and computer science) to produce a map-makers' paradise.

The copy-protected game comes on two double-sided 5¼-inch disks (you need a blank disk to save character information). Joysticks are optional, but a color monitor helps, especially in the wilderness (where, in monochrome, it's hard to tell mountains from swamp).

The game is part maze, part fantasy, and part pinball. You may be frustrated when your third attempt to storm the castle falls flat, but the changes in visual style and pace are wonderful compensation.

Tad Davis

LEGACY OF THE ANCIENTS

Electronic Arts
1820 Gateway Drive
San Mateo, CA 94404
(800) 245-4525
In CA (800) 562-1112

LIST PRICE: \$39.95

REQUIRES: Apple II Plus, IIe, IIc, or IIgs;
64K RAM; one 5¼-inch disk drive; joystick
optional. Copy-protected.

CIRCLE READER SERVICE NO. 402

With the Z-80 Plus[®], run over 5000 new CP/M[®] programs.

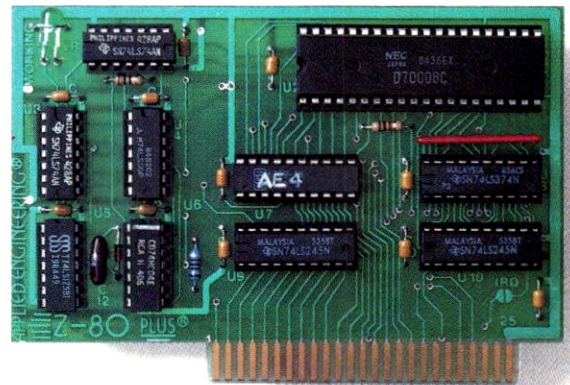

*Now, get two computers
in one, and all the
advantages of both.*

Enter the CP/M world with the new Z-80 Plus card from Applied Engineering, and introduce your Apple IIe, IIgs or II+ to thousands of CP/M programs. Only the Z-80 Plus comes standard with the new 5.1 software, the most advanced system ever for running CP/M programs.

The new 5.1 boasts advanced features like built-in disk emulation for popular memory expansion boards, boosting both system speed and storage capacity. And menu-driven utilities that let you get to work faster. The Z-80 Plus also lets you run older CP/M programs—all the way down to Version 1.6 (2.2 is the most popular).

The Z-80 Plus is the only card on the market capable of accessing more than 64K. If you have an extended 80-column card, all 128K is usable. And if you have RamWorks, RamFactor, gsRam, gsRam Plus, or an Apple memory card in your IIe, IIgs or II+, up to 1088K is available.

Each Z-80 Plus comes with our CP/M Ram Drive software, enabling most memory cards to work as a high-speed Ram disk so CP/M software can run up to *twenty times faster*. So packages like WordStar, dBASE II, Turbo Pascal and most others run at blinding speed.

Simply plug the Z-80 Plus into any slot in your Apple. You'll get the benefits of two computers in one—all at an unbelievably low price (only \$149!).

- Fully compatible with ALL CP/M software
- Fully compatible with 5¼" and 3½" disk drives as well as most hard disks including the Sider
- Fully compatible with Microsoft disks (no pre-boot required)
- Specifically designed for high speed operation
- Runs WordStar, dBASE II, Turbo Pascal, and ALL other CP/M software with *no pre-boot*
- Semi-custom I.C. and low parts count allows Z-80 Plus to fly through CP/M programs with extremely low power consumption (we use the Z-80B)
- Does EVERYTHING other Z-80 boards do, *plus* Z-80 interrupts
- Five-year warranty

To get your Z-80 Plus or for more information see your dealer, or call 214-241-6060 9 a.m. to 11 p.m. seven days, or send check or money order to Applied Engineering. MasterCard, VISA and C.O.D. welcome. Texas residents add 5½% sales tax. Add \$10.00 outside U.S.A.

AE Applied Engineering™
P.O. Box 798, Carrollton, TX 75006
(214) 241-6060

CPM is a registered trademark of Digital Research.

NEW!

APPLE COMPATIBLE PRODUCTS

LOW FACTORY DIRECT PRICES!

**DEALERS CALL!
UNIV & SCHOOL P.O.'s WELCOME!**

ONE MEG RAM BOARDS?

WE'VE GOT EM!

THE Super Expanders!

S.E. IIgs	OK Now	\$49
S.E. IIe	*OK Now	\$59
S.E. IIc	*OK 1/88	\$69
S.E. II+	*OK 3/88	\$79

Above with 256K add	\$30
Above with 512K add	\$60
Above with 1MEG add	\$120

* FREE Appleworks RAM Expansion Software!

QUIET COOLING FANS!

IIgs No Audio Noise	\$25
II+/e w/Surge Protect	\$27

OTHER PERIPHERALS!

64K/80 Column Bd	IIe	\$35
Super 64K/80 Col	IIe	\$49
16K RAM Board	II+	\$35
128K RAM Board	II+	\$65
80 Column Board	II+	\$49
Super Serial Bd	II+/e	\$49
Z80 CP/M Board	II+/e	\$35
Numeric Keypad	IIe	\$35
Graphic Par Bd w/Cble		\$45
Joystick	\$15 &	\$25

A/B SWITCHBOX!

Centronics or Serial	\$29
----------------------	------

ADD ON DISK DRIVE: 5 1/4
Specify Your Model \$119

**TWO YEAR WARRANTY ON ALL PRODUCTS
CALL OR WRITE FOR ILLUSTRATED LISTINGS!
ADD \$3 Shipping / COD ADD \$2 / VISA/MC OKAY 0%^{fin}**

NEXO DISTRIBUTION

**914 E. 8TH ST., Suite 109, National City, CA 92050
(619) 474-3328 10AM-6PM Mon-Fri**

CIRCLE 325 ON READER SERVICE CARD

REVIEWS

RULE, BRITANNIA!

Congratulations! You are the fortunate recipient of a ten-day, all-inclusive trip to London. What sights you'll see, what adventures you'll have! But your luck being what it is, you did not receive your return ticket before you left. "Don't worry!" you were told back in the U.S. "Don't worry!" says the English travel agent who meets you in Victoria Station after you take the train from the airport to the British capital. Rather than giving you your bloody ticket immediately, however, the agent decides to play a game: If over the next few days you can discover the identity of a famous British person, then and only then will the agent hand over your return ticket.

Instead of summoning a bobby or contacting the American embassy, you go along with the plan. After all, this isn't real life—it's the premise of a fun but flawed travel-simulation/trivia-game-with-graphics called Ticket to London.

Now this famous person you're supposed to identify can be a man or a woman, real or fictional—from the present or from the past. You have to solve the puzzle by gathering clues as you explore downtown London.

Here's one set of clues from a game I played—let's see how you do with them. First clue: "She

was born in Switzerland in 1760."

Do you know yet? Hang in there. I'll give you another clue in just a moment.

Upon your leaving Victoria Station, the game displays a map of London's West End, highlighting 20 places of interest. Your first task is to find your hotel among four possibilities. You'll probably waste some time picking a wrong hotel or two—you don't get any help in figuring out which one has your reservation. ("Why?" I asked myself. Even in a game with a premise as absurd as this one, there's no reason for this needless hassle.)

Second clue: "She learned the trade from her uncle."

Among the places of interest on the map are many sites you've probably heard about: Buckingham Palace (where the Queen stays when she's in town), Covent Garden (where the opening scene of *My Fair Lady* takes place), and the British Museum.

You will also become familiar with some landmarks you may not already know of, such as Fortnum & Mason (a high-class store), Portobello Road (an open-air market), and the Tate Gallery (an art museum). You also must visit banks and money-changing locations where you can exchange your American greenbacks for British pounds, at the prevailing exchange rate of course—

FREE RAM 20 MB

FASTDATA Pro

"Highly recommended" - Apple User Groups

- **RAM "Expander"** lets you expand word processor & database files without buying more RAM. Links any number of files into a giant pseudo file that FASTDATA Pro can search, print, split, merge, copy, cut & paste. So fast, it's almost like a 20 megabyte desktop - effectively gives you **FREE RAM**. Needs no extra disk or memory space. **Hypertext** program - even links **different** file types, e.g., TXT to AWP to ADB. Retrieves text from **ALL TYPES** of files.
- **Free-Form Database Manager** - Use with your word processor to create huge databases. Variable delimiter lets you build records of any size or form. You can even re-define records instantly, e.g., as sentence, line, paragraph, chapter, or entire file. Prints: all matches, last match, screen dump.
- **AppleWorks Utility** - Breaks AppleWorks' category and record barriers. Ideal for databases of exam questions, real estate listings, lab logs, writer's journals, bibliographies, resumes, contracts, recipes, genealogies, etc. Converts any ProDOS file to AppleWorks. Switch to/from FASTDATA in 8 secs.
- **Plus:** File finder and previewer. Zoom and scroll. Magic cursor ends prefix and filename typing. Searches **BIOSCIENCE BIOSIS®** files. Word wrap. **FREE Program Selector**. "Smart" help file. School vandal protection. Many more features. For II+, IIe, IIc, IIgs, min. 64K

SUPER INDEX Databases

On disk **summaries** of every article, review, tip program & letter in your magazines. **Cross-references** corrections. Like a "tip book" cites 1000's of answers. **SAVE TIME:** Ends fruitless searches through stacks of magazines. Prevents "re-inventing the wheel". Helps find & fix bugs in published programs. **SAVE MONEY:** Find all the reviews before buying. Reduce repair shop visits. Cut long-distance help calls. Costs less than using most commercial databases just once! **Pays for itself.** Search with FASTDATA.

Add: \$2 Ship/hand., CA res. 6.5% tax, Overseas \$4
FASTFIND Co. 28503 Coveridge Dr., Dept. AX, Rancho Palos Verdes, CA 90274

Hi-Speed Data Retrieval
Search 25,000 chrs. in 1 sec.
AND/OR/NOT & Wildcards
Easy-to-use HYPertext

FASTDATA Pro (ProDOS) \$49.95
FASTDATA 3.3 (DOS 3.3, search) \$19
SUPER INDEX Databases - Any one FREE with FASTDATA:
A+ '87 \$6, '86 \$6, '85-'83 \$10
Call-A.P.P.L.E. '87 \$6,
'86-'85 \$10, '84-'78 \$12
inCider '87 \$6, '86 \$6, '85-'84 \$10
NIBBLE® '87 \$10
OPEN-APPLE '87 \$6, '86-'85 \$10
On 3.5 inch disks add \$2

Not-Copy-Protected
90-day Money-Back Guarantee

FASTDATA Pro (ProDOS) \$49.95
FASTDATA 3.3 (DOS 3.3, search) \$19
SUPER INDEX Databases - Any one FREE with FASTDATA:
A+ '87 \$6, '86 \$6, '85-'83 \$10
Call-A.P.P.L.E. '87 \$6,
'86-'85 \$10, '84-'78 \$12
inCider '87 \$6, '86 \$6, '85-'84 \$10
NIBBLE® '87 \$10
OPEN-APPLE '87 \$6, '86-'85 \$10
On 3.5 inch disks add \$2

VISA/MC (213) 544-2350

CIRCLE 180 ON READER SERVICE CARD

REVIEWS

it fluctuates daily.

Now here's your third clue: "She gave flower-modelling lessons to the sister of Louis XVI." Any ideas yet? I'm sure you've already ruled out both Margaret Thatcher and Princess Di.

As you travel about town, some of the people you encounter will quiz you on British trivia, four questions per encounter, in multiple-choice format. If you don't know the answer, you can attempt to pick the correct response by guessing, but if you don't get it after two tries, the questioner moves along to the next query without telling you which of the answers was right. I fault this part of the game the most. The game's rich database is designed to give you new information every time you play, but its presentation prevents you from learning much that you don't already know, despite the claim on the game's packaging.

Fourth clue: "She came to England in 1802."

Ticket to London is essentially a trivia game, and as with other trivia games, the more knowledge you possess before playing, the more successful you'll be. For example, one of the clues tells you to buy a ticket for "Henry Purcell's opera." Since Covent Garden is on the map and because the documentation tells you that Covent Garden is the place to see opera or ballet, you head in that direction. But once you get there, if you

don't know that the name of Henry Purcell's opera is *Dido and Aeneas*, you won't get another identity clue.

Which brings us to the fifth and, for the time being, final clue (the game can give you up to ten): "She modelled heads of people during the Reign of Terror."

Aha! That one made it simple, right? Who else could it be but "Madame Tussaud," who made death masks of Louis XVI and Marie Antoinette immediately after they were beheaded and whose wax museum is one of London's most popular tourist attractions.

So if this sort of Anglophilic guessing game appeals to you, you might have fun with Ticket to London, but as much as I liked parts of it, I just don't think that its potential has been completely realized.

A personal note: Although the game makes no claim for its usefulness in such a situation, I played it many times just before my first trip to London to familiarize myself with the layout of the city and to get myself in a British frame of mind.

Donald Oliver

TICKET TO LONDON
Blue Lion Software Corporation
P.O. Box 650
Belmont, MA 02178
(617) 489-2477

LIST PRICE: \$39.95
REQUIRES: Apple IIe, IIc, or IIgs; 128K RAM; one 5 1/4-inch disk drive. Copy-protected.

CIRCLE READER SERVICE NO. 403

Viewmaster 80

Now run AppleWorks™ on your II+ and keep full 80 column compatibility!

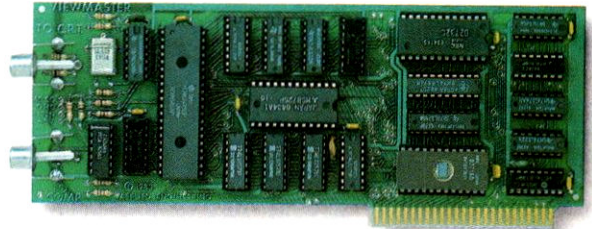

	BUILT-IN SOFTWARE	SHIFT KEY SUPPORT	LOW POWER DESIGN	80 COLUMN MODE	7-D DOT MATRIX	LIGHT PEN INPUTS	80 COLUMN OVERDRIVE	INVERSE CHARACTERS
VIEWMASTER 80	✓	✓	✓	✓	✓	✓	✓	✓
SUPRTERM		✓					✓	✓
WIZARD 80				✓				✓
VISION 80	✓	✓			✓			
OMNIVISION		✓					✓	✓
VIEWMAX 80	✓	✓		✓				✓
SMARTERM	✓	✓				✓	✓	
VIDEOTERM		✓		✓	✓	✓		✓

One look at the chart will give you some of the reasons there's only one smart choice in 80 column cards for your Apple. But the real secret to Viewmaster 80's success is something even better: Total compatibility.

Each Viewmaster 80 includes our powerful AppleWorks expand software, allowing AppleWorks to run on the II+ with only 64K (or more) memory. (We recommend the RamFactor memory card, but any compatible Apple memory card will work.) The software provides our full range of AppleWorks enhancements, including expanded records, word processor, multi-disk saving, time and date display on screen with any PRO-DOS clock, and more!

The Viewmaster 80 works with all 80 column applications, including DOS 3.3, PRO-DOS, CP/M, Pascal, WordStar, Format II, Applewriter II, dBase II, Visicalc, Multiplan, and *hundreds* of others — including AppleWorks.

Here are just a few of the powerful features the Viewmaster 80 delivers for a great price (\$149):

- 80 Characters by 24 lines • Fully compatible with all Apple languages and software • Highest compatibility with existing 80 column software • Very low power consumption • High speed (18 MHz) scroll rate • Upper and lower case characters and true descenders, both inverse and normal; all on-screen editing functions are supported • User-definable cursor shape • Compatible with Apple II, II+ and IIe • Five-year warranty

Call today to order or for more information, 9 a.m. to 11 p.m. seven days, or send check or money order to Applied Engineering. MasterCard, VISA and C.O.D. welcome. Texas residents add 5% sales tax. Add \$10.00 outside U.S.A.

CP/M is a registered trademark of Digital Research, Inc.

AE Applied Engineering
P.O. Box 798, Carrollton, TX 75006
(214) 241-6060

Programs, Peripherals,

Apple Compatible Computers

Central Point Software			
Laser 128 Computer	379.	Laser 128 2nd Disk Drive (5 1/4", 1/2 height)	89.
<i>The Laser 128 includes an Expansion Slot, RGB Video Output, Parallel Printer Port, and a 10 Key Numeric Keypad!</i>			
Laser 128EX Computer	479.	Laser 128 800K 3.5" Drive w/Controller	259.
<i>The Laser 128EX includes a Built-in RAM Expansion Board, Universal Disk Controller, Built-In Expansion Slot, and Ports for all Peripherals!</i>			
		Laser 128 2-Slot Expansion Box	49.
		Laser 128 Cables	16.
		(Parallel, Serial, RGB or Modem)	
		Laser 128 Mouse	49.
		Amdek	
		Amdek Color 600 TRGB (Inc. Tilt & Swivel)	369.
		Taxan I18 Green	110.
		I19 Amber	115.

Backup Utilities & Boards

Alpha Logic Locksmith 6.0	36.	FWB Software	
Central Point Software		Disk Util II (IIgs)	47.
Copy II Plus (5.25" & 3.5" Bit Copy)	23.		

Business Software

Activision		Graphics Edge	54.
Writer's Choice Elite (Not Protected IIgs)	62.	Pinpoint II Upgrade Kit	19.
List Plus (Merges w/Writer's Choice IIgs)	62.	PinPoint Ram Enhancement	19.
Apple Apple Works (IIe, IIc, IIgs)	215.	PinPoint Modem Enhancement	19.
Apple Writer II 2.0 ProDos (IIe, IIc)	125.	ProFILER 3.0	74.
Beagle Brothers Timeout Graph	55.	Random House II Write (IIe, IIc, IIgs)	
Timeout SuperFonts	49.	II File (IIe, IIc, IIgs)	54.
Timeout QuickSpell	45.	Roger Wagner Publishing	
Timeout UltraMacros	37.	Mouse Write (IIe, IIc, IIgs)	89.
Timeout SideSpread, FileMaster, or Desk Tools	32.	Scholastic Talking Text Writer (IIgs)	149.
BPI Systems		Sensible Software	
(Accounting Systems for the IIe, IIc & IIgs)		Sensible Grammar ProDos (3.5" & 5.25")	59.
BPI General Accounting ProDos	139.	Sensible Speller-Dos or ProDos	69.
BPI AR/AP or Inventory ProDos (ea.)	139.	w/3.5 & 5.25"	
BPI Payroll ProDos	139.	Sierra On-Line Smart Money	59.
Broderbund On Balance	42.	Simon & Schuster	
Bank Street Writer Plus	54.	Webster's Spelling Checker (ProDos)	39.
Dac Software Dac-Easy Accounting	54.	Sir-Tech Software, Inc.	
Datapak Graphwriter 2.0 (IIgs)	91.	The Clan Practical Accountant	42.
DNA 'N Files (IIgs)	79.	SoftView TaxView Federal 1987 (IIgs)	72.
DHA Systems Software FastPak Mail	42.	TaxView Planner Supplement	
Electronic Arts DeluxeWrite	69.	1987-1991 (IIgs)	49.
Intuit Quicken	35.	California or New York Supplement 1987 (IIgs)	39.
Manzanita BusinessWorks		Software Publishing	
System Manager (Required)	69.	All Programs for IIe with I28K or IIc	
GL/AR/AP or Inventory Control	139.	PFS: Workmates (File/Report/Plan/Write)	119.
Payroll Module	139.	PFS: File/Report Bundle	69.
BusinessWorks Bundle (Sys. Manager, G/L, A/P, A/R, Inventory)	299.	PFS: Write w/Speller	69.
MECA		Synapse Personal Newsletter	39.
Managing Your Money 3.0 (IIe, IIc, IIgs)	99.	Softword GS File	61.
Monogram Dollars and Sense (IIe, IIc or IIc)	75.	StyleWare, Inc.	
Nolo Press Will Maker (Version 2.0)	36.	Multiscribe 3.0 w/Speller (I28K IIe or IIc)	52.
Peachtree Back To Basics		Multiscribe GS 3.0 (IIgs)	65.
Accounting System: GL/AR/AP	135.	DeskWorks	39.
Pinpoint Publishing Pinpoint IIgs Starter Kit	89.	Picture Manager or Desk Accessories	17.
Pinpoint	49.	Multiscribe Fontpaks 1-8 (each)	15.
Pinpoint Spelling Checker	42.	Timeworks Publish-It	69.
Pinpoint Document Checker	42.	VIP Software	
Pinpoint Speller/Document Checker Combo	65.	VIP Professional	
Pinpoint Toolkit	42.	(Apple IIc or Enhanced IIe)	152.
InfoMerge	48.	VIP Professional (IIgs Version)	183.
Key Player	30.	Word Perfect Corporation	
RunRun	30.	WordPerfect V1.1 w/Speller (IIe & IIc)	89.
Command.Com	42.	WordPerfect (Apple IIgs)	89.

800/832-3201 Customer Service (203) 378-3662
 Mon. thru Fri. 9 A.M. to 9 P.M.
 Sat. 10 A.M. to 6 P.M. (Eastern Time)

OUR POLICIES

- We accept MASTERCARD and VISA with no added surcharge.
- Your credit card is not charged until we ship.
- If we must ship a partial order the shipment that completes the order is sent freight free.
- If you are ordering by mail, we accept private and company checks. With MASTERCARD and VISA orders include card number and expiration date. Connecticut residents add 7.5% sales tax.
- Locations more than 1 day away shipped via Federal Express Standard Air Service.*
- Federal Express Priority 1 Service also available.
- Sorry, we cannot accept COD orders.

SHIPPING

- **Software Only - Continental US:** \$4.00 (Minimum) charge per order to cover Federal Express Standard Air Service. APO/FPO orders shipped 1st Class Mail (add 3% \$5.00 Min charge).
- **Alaska, Hawaii and Outside Continental US:** call or write for information.
- **Hardware Items:** Please call for shipping charges.

RETURNS

- All goods are new and guaranteed by the manufacturer, but we cannot guarantee machine compatibility. Due to software copyright laws, all sales are final. Defective software will be replaced immediately by the same item. Defective hardware will be replaced or repaired at our own discretion. Call customer service at (203) 378-3662 to obtain a Return Authorization Number before returning goods for replacement. Products purchased in error subject to a 20% restocking fee.

All items subject to availability. Prices subject to change without notice.
 *When your order is shipped from our facility in Stratford, CT, Federal Express Standard Air Service will deliver the package in 1 to 2 days. This service does not guarantee next day delivery.

Now Shipping Standard Air Service by 

Entertainment Software

Access Software		Leather Goddesses Of Phobos, Moon Mist, Nord & Bert, Plundered Hearts, Stationfall, The Lurking Horror, or Zork I (each)	25.
World Class Leader Board Golf	28.	Hitchhiker's Guide to The Galaxy	21.
Famous Courses of the World	14.	Beyond Zork or Beyond Zork II (IIgs)	27.
Accolade Mean 18 (IIgs) or Hardball (IIgs)	27.	The Zork Trilogy	46.
Famous Course Disk Vol. 2	12.	Micro League Sports Micro League Baseball	27.
Famous Course Disk Vol. 3 & 4	22.	General Manager/Owner Disk	27.
Hard Ball	22.	Team Disk 1987	14.
Activision Aliens, The Last Ninja or Rampage	24.	Microprose F-15 Strike Eagle or Silent Service	23.
Blackjack Academy	28.	Silent Service II or Pirates	28.
Firepower	18.	Mindscape Defender of the Crown (IIgs)	37.
GBA Championship Basketball (IIgs)	31.	Infiltrator II	24.
GFL Championship Football	27.	Balance of Power	34.
The Last Ninja (IIgs) or Hacker II (IIgs)	32.	Sub Mission	28.
Might & Magic	27.	Bad Street Brawler or Into the Eagles Nest	24.
Music Studio II (IIgs)	64.	Super Ice Hockey	28.
Portal or Shanghai (IIgs)	30.	Championship Boxing	27.
Star Rank Boxing II	28.	Paperboy or Paperboy (IIgs)	27.
Tass Times In Tonetown or Maniac Mansion	24.	Sinbad, S.D.I. or King of Chicago (IIgs)	34.
Tot Fuel Eliminator or Shanghai	21.	Indoor Sports, Uridium, or Xevious	21.
Artworx Bridge 5.0	21.	One Step Software	
Baudville Dream Zone (IIgs)	31.	Golf's Best Pinehurst or St. Andrews	15.
Ski Crazy	19.	PBI Software	
Broderbund 2400 A.D.	27.	The Tower Of Myrallan (IIgs) or Alien Mind	34.
Wings of Fury (IIe, IIc, IIgs)	24.	Strategic Conquest II or Cavern Cobra (IIgs)	31.
Championship Lode Runner or Karateka	24.	Sea Strike or Monte Carlo (IIgs)	25.
Ultima IV or Ultima V	42.	Random House APBA Major League Baseball	41.
Autoduel	34.	Sierra On-Line	
Bulseye Ticket to London, Paris, Spain, or Washington D.C.	28.	Space Quest or Space Quest II (IIgs)	34.
Data East Karate Champ or Kung Fu Master	15.	Championship Boxing	27.
Tag Team Wrestling or Commando	24.	Kings Quest I, II, or III (APII or IIgs Ver.)	34.
DianaSoft Goonies	15.	Leisure Suit Larry (APII or IIgs Ver.)	27.
Electronic Arts Bards Tale	32.	Thexder (IIgs)	24.
Bards Tale (IIgs), Instant Music (IIgs), or Music Construction Set (IIgs) (each)	39.	The Black Cauldron	27.
It's Only Rock & Roll or Hot & Cool Jazz	22.	R-3D Helicopter Simulation (IIgs)	34.
Bard's Tale II	34.	Mother Goose	21.
Alternate Reality: The Dungeoneer, Arctic Fox, ChessMaster 2000, Legacy of the Ancients, Deathlord, Chuck Yeager Flight Sim., Scrabble, PHM Pegasus or World Tour Golf (IIgs) (each)	29.	Police Quest or Police Quest II (IIgs)	34.
EOS, Strike Fleet, or Marble Madness or Marble Madness (IIgs) (each)	25.	Simon & Schuster	
Dark Lord or Force 7	16.	Star Trek (Kobayashi Alternative)	21.
Adventure Construction Set, Lords of Conquest, Make Your Own Murder Party, or Realm of Impossibility (each)	12.	Star Trek (The Promethean Prophecy)	27.
EPYX California Games (IIe or IIgs Ver.), Dive Bomber, Championship Wrestling, Destroyer (IIe or IIgs Ver.), Omnicron Conspiracy, Sub Battle Simulator (IIe or IIgs Ver.), Summer Games II, Street Sports: Baseball, Street Sports: Basketball, Winter Games (IIe or IIgs Ver.), Home Video Producer, Sporting News Baseball, Stickler Maker, Street Sport Soccer, The Games: Winter Edition, or World Games (IIe or IIgs Ver.) (each)	26.	Sir-Tech Wizardry	32.
Rad Warrior	18.	Knight of Diamonds	32.
The Movie Monster Game	15.	Legacy of Lyllygarn	27.
World's Greatest Baseball or Football Game	15.	Return of Werdna	39.
Firebird Elite	17.	Deep Space-Operation Copernicus	27.
Guild of Thieves	27.	Software Simulations	
Hayden Software Sargon III	15.	Pure Stat College Basketball (IIe, IIc, IIgs)	28.
Infocom		Baseball (IIe, IIc, IIgs)	28.
Border Zone, Bureaucracy, Hollywood Hyjinx,		Football (IIe, IIc, IIgs)	21.
		Spectrum Holobyte Gato	12.
		Gato (IIgs)	25.
		Orbiter (IIgs), Wilderness or Dondra	31.
		Strategic Simulations	
		Colonial Conquest, Roadwar 2000, Realms of Darkness, Shard of Spring, The Eternal Dagger, or Wizard's Crown (each)	28.
		Battle Crusade, Battle Group, Kampfgruppe, Mech Brigade, Sons of Liberty, Warship, or War in the South Pacific (each)	40.
		Battle of Antientam or Chickamunga	34.
		Gemstone Healer	21.
		Carriers at War	36.
		Sublogic Flight Simulator II	36.
		Jet	30.
		Scenery Disks 1, 2, 3, 7, or II (ea)	16.

Utilities & Languages

Absoft		Roger Wagner SoftSwitch (IIgs)	39.
AC/Basic (16-bit BASIC Compiler for IIgs)	99.	Merlin 8/16 (IIe, IIc, IIgs)	79.
Apple Computer Apple II Instant Pascal	119.	The Byte Works ORCA/Pascal (IIgs)	89.
Apple Pascal V1.3	215.	ORCA/Pascal Desktop Debugger	99.
Beagle Brothers		ORCA/M 4.1	72.
Beagle Screens, Big U, MacroWorks, or Pro-Byter (each)	21.	ORCA/M GS	49.
Beagle Compiler	46.	APW DeskTop	42.
Beagle G.P.L.E. or Super MacroWorks	31.	TML Systems TML Basic for the GS	89.
D-Code, Extra K, Power Print or Triple Dump (each)	25.	TML Pascal for the GS	35.
Borland Turbo Pascal 3.0 (Req. CP/M)	48.	TML Source Code Library for the GS	35.
Funk Software Sideways Prodos & Dos 3.3	47.	TML Speech Toolkit	49.
		TML Pascal APW	89.
		Zedcor ZBasic 4.0	42.

Accelerators/Ramcards/Z-80/80 Column Cards

Apple Computer		Z-RAM Ultra 2 or 3 (256K to 1MB)	Call
Apple IIe Extended 80 Col. Card	89.	GS-RAM (256K to 1.5Meg)	Call
Apple IIe Enhancement Kit	49.	GS-Ram Plus (1MB to 6MB)	Call
Applied Engineering		Phasor (IIe, IIc, and IIgs)	139.
RamKeeper	149.	TransWarp Accelerator (IIe and IIc)	169.
RamWorks Basic (256K or 512K)	Call	ViewMaster 80 (IIe)	129.
RamWorks III (64K to 3 MB)	Call	Z-80 Plus (IIe, IIc, IIgs)	129.
2 Meg Plus RamWorks Expander (1 or 2 MB)	Call	AST Research	
PC Transporter (384K to 768K)	Call	Ramstack Plus IIgs (256K Exp. to 1MB)	105.
PC Transporter Installation Kit (IIe or IIgs)	Call	Checkmate Technology MemorySaver (IIgs)	119.
RamFactor (256K to 1MB)	Call	Orange Micro RamPak 4GS	
Z-RAM Ultra 1 (256K or 512K)	Call	(512K Exp. to 4MB w/Utilities)	229.

Printer Interface Cards

Apple Apple Super Serial Card	119.	SMT Envoy (Super Serial type Interface)	67.
Applied Engineering Buffer Pro 32K	85.	Printech II (Parallel Interface)	37.
Buffer Pro I28K or 256K	Call	Thirdware Finger Print GSI	69.
Serial Pro (IIe, IIc, IIgs)	119.	Finger Print Plus	
Parallel Pro (IIe, IIc, IIgs)	79.	(Specify Cables: Parallel, Serial or ImageWriter II-IIe & IIc)	89.
Orange Micro ProGrappler (Apple IIe or IIgs)	79.	FingerPrint IIe (Internal or External Ver.)	74.
Serial Grappler Plus	61.	Finger Print G+ (With Parallel Cable IIe, IIc, IIgs)	55.
Grappler C/Mac/GS	65.		
Hot Link	54.		

Phenomenal Prices...

Graphics Packages

Acolade Graphics Studio (IIGs)	42.	Print Shop Graphics Library Party Edition	24.
Activision Draw Plus (Not Protected IIGs)	59.	Show Off (IIGs)	42.
Paint/Write/Draw (Not Protected IIGs)	115.	Data Transforms Printrix I.I	46.
Clip Art Gallery (Req. PaintWorks Plus IIGs)	21.	Monster Font Pack	21.
GameMaker Maker Bundle	34.	Electronic Arts DeluxePaint II (IIGs)	37.
PaintWorks Gold	64.	DeluxePrint II (IIGs)	26.
Postcards (IIGs)	21.	Art Parts 1 or II, or Seasons & Holidays (IIGs)	41.
Postcards (Ile & Ile)	18.	EPYX Printmagic	17.
Greeting Card Maker	28.	Graphics Scrapbook Chapter #1, #2, or #3	21.
Bantam Software		Create-A-Calendar	21.
Wait Disney Card & Party Shop	27.	Intracorp Bumper Sticker Maker	34.
Wait Disney Comic Strip Maker	27.	Business Card Maker	36.
Baudville 816/Paint (Works On All Apples)	46.	The Video Wizard	42.
Award Maker Plus	24.	PBI Software Visualizer (IIGs)	59.
Take 1 Deluxe	36.	Visualizer IIe	55.
Animation Library or Zany Characters	18.	Scholastic SuperPrint (IIGs)	31.
Beagle Brothers Beagle Graphics	36.	Spinnaker T-Shirt Shop	34.
Minipix Disk #1, #2 or #3 (each)	19.	T-Shirt Shop Graphics	15.
Shape Mechanic	25.	Springboard Newsroom	35.
Berkeley Software GEOS	64.	Springboard Publisher (Ile, IIG, IIGs)	79.
Broderbund Toy Shop	34.	Certificate Maker	26.
Animat	45.	Certificate Maker Library #1	20.
Dazzle Draw	39.	Fonts For Springboard Publisher	26.
Drawing Table (IIGs)	62.	Newsroom Clip Art Collection Vol. 1 or 3	18.
Print Shop Enhanced or Fantavision	32.	Newsroom Clip Art Collection Vol. 2	25.
Print Shop (IIGs) or Fantavision (IIGs)	42.	Graphics Expander Vol. 1 or Laser Drivers	25.
Print Shop School Edition	48.	Style Sheets/Newletters	19.
Dazzle Draw School Edition	48.	Works of Art Education, Holidays	26.
Print Shop Companion	25.	or Assortment (each)	59.
Print Shop Graphics Library 1, II, III	16.	StyleWare, Inc. TopDraw (IIGs)	59.
or Holiday Ed.	16.	Unison World Printmaster Plus	31.
Print Shop Graphics Library Sampler Edition	24.	Art Gallery 1 or Art Gallery II	19.

Educational Software

Activision Mavis Beacon Typing	29.	Great Wave Kidstime II (IIGs)	24.
Term Paper Writer	34.	SpaceLace	21.
Barron's Computer SAT Revised Version	34.	Harcourt, Brace, Jovanovich Computer SAT	27.
Baudville Guitar Wizard	19.	Learning Company Reader Rabbit (IIGs)	41.
Ted Bear Discovers...Rainy Day Games	19.	Writer Rabbit (IIGs), Think Quick (IIGs)	34.
Britannica Algebra I, 2, 3, or 4	25.	or Rockys Boots (IIGs)	28.
Algebra 5 & 6	31.	Magic Spells (IIGs)	31.
Designasaurus (IIGs)	24.	Gertrude's Secrets (IIGs)	31.
Broderbund Geometry	68.	Think Quick or Writer Rabbit	30.
Science Tool Kit Master Module	51.	Reader Rabbit or Magic Spells	26.
Science Tool Kit Module I or II	27.	Gertrude's Puzzles or Secrets	31.
Type!	31.	Word Spinner	23.
Variable Feasts	35.	Math Rabbit	26.
Where in the World is Carmen Sandiego?	26.	Robot Odyssey I or Rocky's Boots	32.
Where in the USA is Carmen Sandiego?	29.	Mindscape Crossword Magic	34.
Where in Europe is Carmen Sandiego?	31.	Perfect Score SAT	48.
Compu-Tech Once Upon A Time	25.	PinPoint Micro Cookbook (Ile or IIG)	31.
Stepping Stones Level I	25.	Bon Appetit	37.
Stepping Stones Level II	25.	Simon & Schuster	27.
See the U.S.A.	36.	Speed Reading Tutor IV	34.
Davidson & Associates		Speed Reading Tutor IV (IIGs)	34.
Alge-Blaster, Classmate or Math Blaster Plus	30.	Typing Tutor IV (Ile, IIG, or IIGs)	34.
Grammar Gremlins or Read 'N' Roll	30.	Spinnaker Kindercomp Gold	26.
Homeworker	55.	Homework Helpers Writing or Math (Ile or IIGs Ver.)	32.
Speed Reader II	41.	Typing Made Easy	32.
Spell-It or Word Attack!	30.	Facemaker: Golden Edition	26.
Math & Me	25.	Kidwriter	27.
Designware Grammar Examiner	25.	Terrapin Enhanced Terrapin Logo V3.0	69.
Spellicopter or Math Maze	25.	Weekly Reader	
Body Transparent	25.	<i>Stickybear Series:</i> Sticky Bear ABC, Car	
States & Traits	25.	Builder, Basic, Drawing, Math I, Math II,	
First Byte/Electronic Arts		Math Word Problems, Numbers, Opposites,	
Mathtalk, Kidtalk, First Shapes, Speller		Parts of Speech, Printer, Reading, Reading	
Bee, or Smoothtalker (IIGs) (each)	36.	Comprehension, Shapes, Spellgrabber,	
Mathtalk Fractions or First		Typing, Townbuilder, Vocabulary	
Letters & Words (IIGs)	36.	Development, or Writer (each)	25.

Modems

Anchor Automation		Practical Modem 2400 SA	199.
Signalman Lightning 2400	299.	Prometheus Pro Modem 1200 (External)	239.
1200E	119.	Pro Modem 1200G (Non Expandable)	139.
2400E	159.	Pro Modem 2400 (External)	309.
Applied Engineering		Pro Modem 2400G (Non Expandable)	179.
DataLink Modem (300/1200 Baud		Pro Modem 1200A (Single Card)	169.
Internal Modem II, Ile, IIGs)	169.	Pro Modem 300c	89.
Hayes Hayes Micromodem IIe (Internal)	149.	Communications Buffer (2K Exp. to 512K)	105.
Hayes Smartmodem 1200A (Internal)	265.	Supra Corporation	
Hayes 300 Baud Smartmodem		Supra Modem 2400 (Hayes Compatible)	149.
Ile w/Smartcom I	187.	U.S. Robotics U.S. Robotics Sportster 1200	119.
Hayes 1200 Baud Smartmodem	299.	U.S. Robotics Courier 1200	199.
Hayes 2400 Baud Smartmodem	449.	U.S. Robotics Courier 2400	349.
Practical Peripherals		U.S. Robotics Courier 2400E	379.
Practical Modem 1200 SA	129.	U.S. Robotics Courier HST 9600	689.

Disk Drives & Hard Disk SubSystems

American Micro Research (Micro Sci)		SD 40 (40MG Hard Drive)	879.
A5 D Half Height 5 1/4" Drive	149.	First Class Peripherals	
(IIGs Daisychain)	149.	Sider 20MB Hard Drive	549.
A2 Full Height (II+ & Ile)	139.	Sider 40MB Hard Drive	839.
A.5 Half Height (II+ & Ile)	139.	B-Sider 60MB Tape Backup	839.
A.5C Half Height (IIG)	52.	Blank Tape 5 Pack	65.
Micro Sci C2 Controller	52.	Revision D (Chip/Software for CP/M)	52.
Applied Engineering Transdrive 360K	215.	Hi-Tech Peripherals	
Transdrive Dual 360K	319.	Full Height 5 1/4" Drive for Apple IIe (Beige)	139.
Transdrive Half Height 360K	109.	Half Height 5 1/4" Drive for	
Central Point Software		Apple IIe or IIG (Beige)	139.
Universal Disk Controller	79.	Half Height 5 1/4" Drive for	
Central Point 800KB Drive	185.	Apple IIe or IIG (Platinum)	149.
Universal Disk Controller/800KB		Half Height 5 1/4" Drive Platinum for IIGs	169.
Drive Bundle	259.	Apple IIc Drive Adaptor	15.
CMS SD 20 (20MG Hard Drive)	579.	Mitac AD-3C Slimline IIc	129.

Accessories

Apple Computer Apple Mouse IIe	125.	System Saver (IIGs)	79.
Apple Mouse IIc	89.	Turbo Mouse (Reg. or ADB)	82.
Applied Engineering		Kraft Kraft Universal 3 Button	
TimeMaster H.O.	85.	Joystick (II+ Ile, IIG)	34.
Ine System Clock	55.	Koala Technologies	
IBM Style Keyboard	109.	Koala Pad Plus w/Graphics Exhibitor	84.
CH Products		MDideas	
Hayes Mach II Joystick (Beige or Platinum)	38.	Conserver (IIGs Switched Surge	
Hayes Mach III Joystick (Beige or Platinum)	29.	Suppressor w/Fan)	119.
Hayes Flight Stick	52.	SuperSonic (Stereo Card for IIGs)	52.
Curtis Curtis Emerald	36.	SuperSonic Digitizer (IIGs)	52.
Curtis Ruby	64.	Mouse Systems A+ Mouse (IIG)	69.
Curtis Ruby Plus	50.	A+ ADB Mouse (IIGs)	89.
Curtis Diamond Plus	40.	MousTrak	
DataDesk		MousePad 7"x9" Size	8.
DataDesk ADB-101	159.	MousePad 9"x11" Size	9.
Enhanced Keyboard (IIGs)		MousePad L/F (Low Friction)	9.
Kalmar		Orange Micro	
Teakwood Rolltop Disk Case (Holds 50)	18.	Juice Box (IIGs Switched Surge	
Kensington		Suppressor w/Fan)	69.
Mouse Pocket (Reg. or ADB)	8.	SMT	
Mouseway (Mousepad)	8.	No Slot Clock (II+ & Ile)	42.
Apple IIGs Dust Cover or		Street Electronics	
Imagewriter I or II Cover	10.	Echo IIb Speech Synthesizer (II+, Ile, IIGs)	109.
Mouse Cleaning Kit w/Pocket	17.	Cricket IIc	125.
Disk Drive Cleaning Kit (3.5" Drives Only)	20.	Ribbons Unlimited	
Apple Security System	34.	ImageWriter Ribbon-Black	4.50
Printer Muffler 80	38.	ImageWriter Ribbon-Color	5.
Printer Muffler 132	51.	ImageWriter II - 4 Color Ribbon	11.
Printer Muffler Stand 80 or 132	61.	ImageWriter Rainbow Pk. (6 Colors)	25.
A/B Box (IIGs)	23.	Thunderware	
System Saver (Platinum or Beige)	69.	Thunderscan Apple (IIGs, Ile, and IIc)	179.

Blank Media

5 1/4" Blank Diskettes		Bulk (Sony) 3 1/2" DS/DD (box of 10)	16.
BASF 5.25" SS/DD (box of 10)	8.	Centech 3 1/2" DS/DD Color Disks (box of 10)	19.
Verbatim 5.25" SS/DD (box of 10)	10.	Sony 3.5" DS/DD (box of 10)	18.
Sony 5.25" SS/DD (box of 10)	9.	Fuji 3.5" DS/DD (box of 10)	20.
Maxell 5.25" SS/DD (box of 10)	10.	Maxell 3.5" DS/DD (box of 10)	20.
3M 5.25" SS/DD (box of 10)	11.	Verbatim DS/DD (box of 10)	20.
3 1/2" Blank Diskettes		3M 3.5" DS/DD (box of 10)	20.
BASF 3.5" DS/DD (box of 5)	9.	C. Itoh 3.5" DS/DD Color Disks (box of 10)	25.

Printers

Brother		Microline 192Plus (200cps Dot Matrix 10")	339.
M-1109AP ImageWriter Comp.	249.	Microline 193Plus (200cps Dot Matrix 15")	489.
Epson LX-800	Call	Microline 292P (240cps Dot Matrix 10")	539.
FX-86c	Call	Microline 293P (240cps Dot Matrix 15")	639.
FX-286c	Call	Panasonic	
EX-800 or EX-1000	Call	KXP-1080 I/M2 (144 cps) NLQ Mode	199.
LQ-800 or LQ-850	Call	KXP-1091 I/M2 (192 cps) NLQ Mode	209.
LQ-1050 or LQ-2500	Call	KXP-1092 I (240 cps) NLQ Mode	329.
Okidata		Seikosha	
Microline 182P (120cps Dot Matrix 10")	249.	Seikosha SP 1000 (Imagewriter Compatible)	219.

Communication Software

Activision Telcomm Plus	64.	Pinpoint Point-To-Point	79.
Checkpoint Technology		United Software Industries	
ProTERM (IIGs, Ile, IIG)	79.	ASCII: Express Pro: Prodos or Dos 3.3	75.
Compuserve Compuserve Starter Kit	24.	ASCII: Express Mousetalk	59.

Positively A Plus!

PROGRAMS PLUS

75 Research Drive
Stratford, Conn. 06497

Telephone Hours: Monday-Friday 9-9
Saturday 10-6

Orders Only TOLL-FREE
1-800-832-3201

BY SHANON CULLEN

A collection of interesting products for you and your Apple II-series computer

PRODUCT ROUNDUP

GREAT CHEFS ON YOUR APPLE

Great Chefs is a software collection of recipes based on the PBS-television cook-

ing series of the same name. Each two-disk volume contains more than 100 recipes by great chefs from different parts of the world, all

The Great Chefs software contains hundreds of recipes.

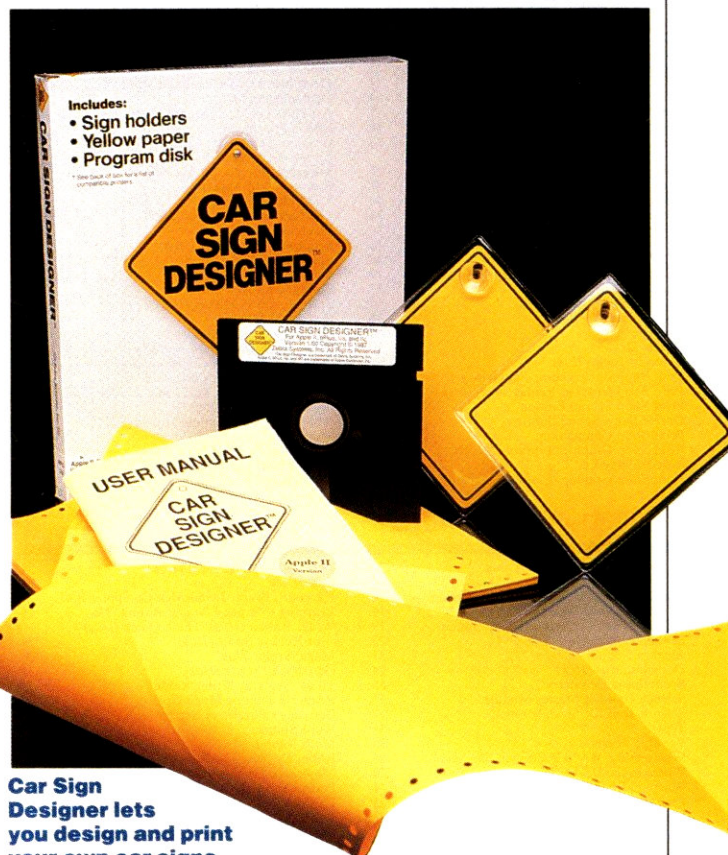

Car Sign Designer lets you design and print your own car signs.

cross-indexed by virtually every item in every recipe. The meal-planning software that comes with each volume or set allows you to select dishes based on ingredients, cooking time, and method of cooking; to re-scale recipes for any size group; and to print out your selections. In addition to the recipes, the program includes cooking tips, anecdotes, and wine suggestions from the chefs. Volumes are divided alphabetically by chefs' last name (Volume 1: A-F, Volume 2: G-N, Volume 3: O-Z).

List Price: \$24.95 per volume; three-volume set, \$65
Requires: Apple IIe or IIc; 128K RAM; one 5¼-inch disk drive. DOS 3.3; not copy-protected.
Concept Development Associates, Inc.
45 Cordova Street
St. Augustine, FL 32084
(904) 825-0220

CIRCLE READER SERVICE NO. 501

CAR SIGN DESIGNER PACKAGE

Car Sign Designer allows you to use your Apple II to design and print out diamond-shaped car signs with up to four lines of text. The program automatically centers each line and adjusts character width on each line. The character set includes the letters A to Z, digits 0 to 9, special symbols, and punctuation. The package includes two clear-plastic sign holders (five inches per side) with suction cups, and 50 sheets of bright-yellow fanfold computer paper.

List Price: \$29.95
Requires: Apple II Plus, IIe, or IIc; 64K RAM; one 5¼-inch disk drive; printer. ProDOS; copy-protected.
Zebra Systems, Inc.
78-06 Jamaica Avenue
Woodhaven, NY 11421
(718) 296-2385

CIRCLE READER SERVICE NO. 502

MAVIS BEACON TEACHES TYPING

Mavis Beacon Teaches Typing is a typing tutorial that includes, as its practice lessons, quotes from history's greatest writings, riddles, rhymes, and jokes, in addition to hundreds of facts from *The Guinness Book of World Records*. The program features 2-D and 3-D graphics, "guide hands" that type with you and show proper technique, and help windows for each stage of every lesson. The program also includes an arcade-type Road Racer typing game and a musical "Tempo Typing" section with an on-screen metronome. More than 20 color graphs display your progress at any time.

Both word-processing and typewriter modes are available. The package includes a typing textbook as well as a program called Resume Writer.

List Price: Apple II Plus, IIe, or IIc version, \$39.95; Apple IIgs version, \$44.95; backup, \$5; hard-drive-installable disk, \$10

Requires: Apple II Plus, IIe, or IIc; 64K RAM; two 5¼-

HOUSE-A-FIRE!

House-a-Fire is a program designed to teach fire safety and fire prevention to students in grades 2-8. The program consists of a database of scientific/safety information and two simulations, *The Firefighter* and *Make It Safe*.

In *The Firefighter*, students prepare for work, select gear and clothing, and fight a fire. Some of the tasks include determining the type of fire and the most

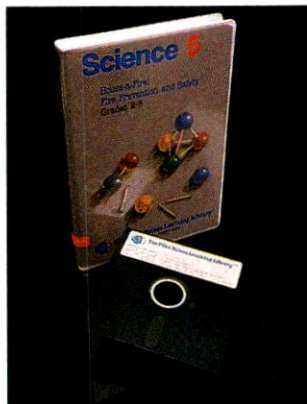

House-a-Fire

appropriate substance to use to extinguish it, and dealing with utilities and weather.

In *Make It Safe*, students move into and furnish a new house and try to make it safe from fire. If they are unsuccessful, a fire breaks out, and they must decide to evacuate or try to fight the fire. If the students safely extinguish the fire, they may choose to search the house for all the other fire hazards.

List Price: \$49.95

Requires: Apple IIe, IIc, or IIgs; 64K RAM; one 5¼-inch disk drive. Copy-protected.

Decision Development Corporation
2680 Bishop Drive
Suite 122

San Ramon, CA 94583
(415) 830-8896

CIRCLE READER SERVICE NO. 504

GRADER-AIDER (VERSION 5.2)

Grader-Aider is a grading program designed for all teachers, from kindergarten through college. It can hold 120 assignments or 200 students per class, with up to 15 classes per disk. It offers three different grading sys-

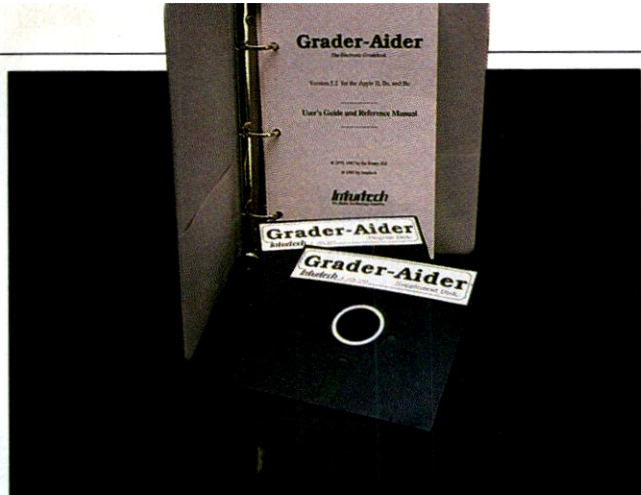

Grader-Aider is designed for teachers of all grades.

tems—points, percentages, and weights.

The program can produce six kinds of reports: individual student progress, class score, final score, assignment score lists, missing-assignment lists, and failing notices. Teachers can tailor reports by using options such as ranking, statistics, assignment selection, and multiple-low-score dropping. You can add comments to any report and save reports as text files for use with most word-processing programs.

List Price: single-user version (not available to schools), \$45; unlimited schoolwide license, \$235; demonstration disk, \$6

Requires: Apple II Plus, IIe, IIc, or IIgs; 48K RAM; one 5¼-inch disk drive; printer recommended. DOS 3.3; not copy-protected.

Intuitech
69 South 400 East
Orem, UT 84058

Written inquiries only

CIRCLE READER SERVICE NO. 505

ICONIX

Iconix is a super-hi-res graphics and animation interface for Applesoft and the Apple IIgs. It includes 16 new commands for Applesoft that link your BASIC programs to the super-hi-res screen. Iconix lets you plot all 4096 colors in the 320 mode; edit, plot, float, or animate icons; and plot super-hi-res fonts in any color. You can increase the potential size of your Applesoft programs by 16K and create your own menus or screen environments with mouse control.

List Price: \$39.95

Requires: Apple IIgs; 512K RAM; one 3.5- or 5¼-inch disk drive. ProDOS; not copy-protected.

So What Software
10221 Slater Avenue
Suite 103

Fountain Valley, CA 92708
(714) 964-4298

CIRCLE READER SERVICE NO. 506

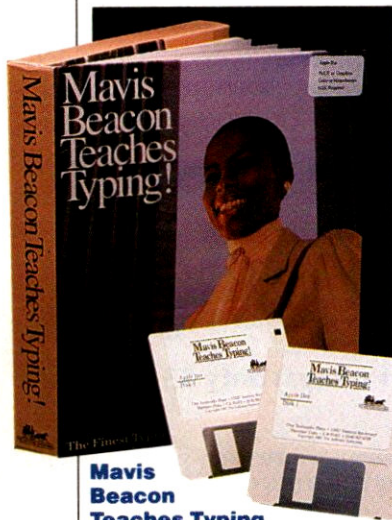

Mavis Beacon Teaches Typing

inch disk drives—or Apple IIgs, 512K RAM, one 3.5-inch disk drive. Copy-protected.

The Software Toolworks
One Toolworks Plaza
13557 Ventura Blvd.
Sherman Oaks, CA 91423
(818) 907-6789

CIRCLE READER SERVICE NO. 503

Iconix, a super-hi-res graphics interface for the IIgs

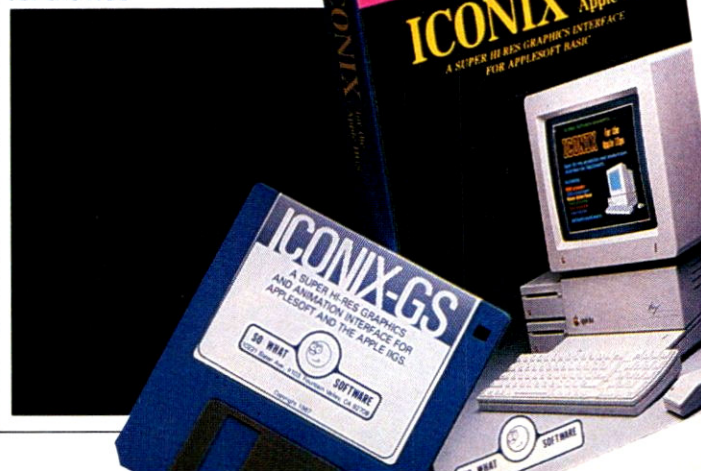

THIS IS WHAT WE DO BEST...

If you use your Macintosh for business, professional or educational applications, you need MacUser—the Mac power resource! Every issue of MacUser delivers incisive product evaluations—complete with benchmark test results from MacUser Labs, the publishing industry's *only* independent Macintosh product testing authority. You'll find in-depth coverage of the MacPlus, desktop publishing, graphics, telecommunications, programming and more! Plus, you'll have direct access with technical questions to the experts at Apple Computer, Inc. AND receive hundreds of product reviews in each issue!

MacUser provides you with special "MacHints" for increased productivity—how to squeeze more from the most popular programs—how to turn your system into a more powerful tool—how to avoid nagging bugs and how to be a more powerful power user!

Your subscription to MacUser delivers 12 fact-filled issues a year to help you upgrade your system and increase the ways you work with and use your Mac!

Increase your power and performance, subscribe to MacUser today and save up to 63% OFF the annual single-copy price of \$47.40!

**One year (12 issues) only \$19.97—
SAVE 58%!**

**Two years (24 issues) only \$34.97—
SAVE 63%!**

Savings based on annual single-copy price of \$47.40. Basic annual subscription price is \$27.

MacUser

**FOR FAST SERVICE, CALL TOLL-FREE
1-800-525-0643!
(In Colorado, 1-303-447-9330)
4Z8S**



PRODUCT ROUNDUP

SOFTWARE

HOW THE WEST WAS ONE + THREE X FOUR

How the West Was One + Three X Four is a mathematics game for grades 4-12. It involves a race between a stagecoach and a locomotive, each "driven" by a student. Students decide on the length of their moves by forming three randomly generated numbers into equations, using addition, subtraction, multiplication, and division.

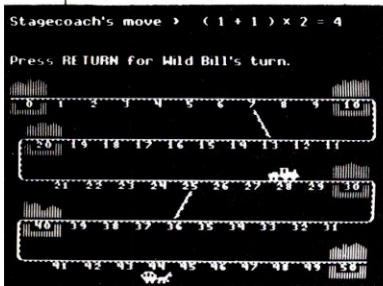

A mathematical game from Sunburst

List Price: \$65

Requires: Apple II Plus, IIe, IIc, or IIGs; 48K RAM; one 5¼-inch disk drive. Copy-protected.

Sunburst Communications, Inc.
39 Washington Avenue
Pleasantville, NY 10570
(800) 431-1934
In Canada (800) 247-6756
In NY (914) 769-5030

CIRCLE READER SERVICE NO. 507

TEENAGE STRESS PROFILE

The Teenage Stress Profile is a program that creates a comprehensive profile of the stressful aspects of a teenager's life.

The program provides individualized reports based on teenagers' response to several sets of questions. These reports identify physical and psychological

symptoms of stress that teenagers may be experiencing, evaluate their vulnerability to stress, outline specific problems that they are experiencing, and make suggestions on how to deal with these problems. You can print out the reports.

Each individual's profile is evaluated in terms of norms for the teenage and general population. The program can be used alone or under the direction of a counselor.

List Price: \$99; lab packs, \$287

Requires: Apple II Plus, IIe, IIc, or IIGs; 48K RAM; one 5¼-inch disk drive. Copy-protected.

HRM Software
175 Tompkins Avenue
Pleasantville, NY 10570
(800) 431-2050
(914) 769-6900

CIRCLE READER SERVICE NO. 508

PROFESSIONAL BASEBALL HANDICAPPING SYSTEM

The Professional Baseball Handicapping System for Baseball Enthusiasts allows you to handicap baseball games by using information from the daily newspaper sports section. The computer performs the statistical analysis to predict the winner, the point spread, and the total points in each game. You can print the data or have it displayed.

List Price: \$49.95
Requires: Apple II Plus, IIe, IIc, or IIGs; 48K RAM; one 5¼-inch disk drive. DOS 3.3; not copy-protected.

Software Exchange
P.O. Box 5382
West Bloomfield, MI 48033
(800) 527-9467 (orders only)
(313) 626-7208

CIRCLE READER SERVICE NO. 509

WORDS & CONCEPTS

Words & Concepts is a program for special education and rehabilitation of both children and adults. The program combines speech, graphics, and animation to provide vocabulary and concept training. A core vo-

You probably already know that Computers Need Maintenance!

But did you know that with *Intelligent Tools* your computer can maintain and diagnose itself?

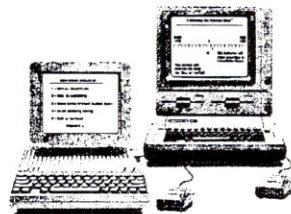

MASTER DIAGNOSTICS™

Master Diagnostics provides all of the tools and knowhow necessary so that *anyone* can do monthly maintenance duties. Calibrating disk drive speed, cleaning drive heads, checking track alignment or just adjusting your monitor to peak clarity is a snap.

In addition to the maintenance routines, extensive diagnostic procedures are available at the touch of a key. With our **new diagnostic construction set**; you can create peripheral diagnostics for any device card. Problems are diagnosed down to the chip level and tests will report: *what's right, what's wrong, what to do and how to do it.* Not just pass-fail type exams!

The user manual is easy to understand and is packed with money saving U-DO-IT information. The Drive Analyzer tests and calibration routines alone will pay for Master Diagnostics after using it just once.

Expert Opinions

Nibble magazine says, "This program should be in the library of every Apple user". Howard Sams Tech Manual, Apple Orchard, InCider Popular Computing, and the Apple II Review have all awarded Master Diagnostics with triple AAA ratings. *Consumers Guide chose Master Diagnostics as one of the best programs for 1985.* Used by Apple service centers world-wide.

WHEN ORDERING SPECIFY:

version: II+, IIe or IIc

Master Diagnostics - \$75.00 r 6.1

Drive Analyzer alone - \$39.95
(Included with MD)

Visa, MC, COD, School PO's

Call Free 1-800-835-2246

Apple Diagnostics
Since 1979

NIKROM

Technical Products, Inc.

176 Fort Pond Road ♦ Shirley, MA. 01464

Upgrades - return
diskette and \$20.00

CIRCLE 329 ON READER SERVICE CARD

Clarity

Open-Apple is Tom Weishaar's monthly newsletter for knowledgeable Apple II users. It's thin but packed tight with Apple II lore, humor, letters, tips, advice, and solutions to your problems. Compared to other Apple II publications, **Open-Apple** has the highest new-idea-per-issue ratio, the clearest writing, the funniest cartoons, the longest index, the best warranty (all your money back if you're not satisfied), and it takes up the least shelf space.



II cue #48

A IIGs *Finder* limitation that many people have run into is that it won't copy the contents of a 3.5 disk into /RAM5. The problem is that *Finder* automatically loads the contents of disks to be copied into IIGs RAM to make the copy procedure go faster. Once it has done this, however, there isn't enough room left in /RAM5 to hold the contents of the 3.5. For more, see the February 1988 **Open-Apple**, page 4.5.

From our fan mail:

"Lee Raesly directed questions and added his input to a panel of four Apple II stalwarts....A brief recounting of their answers may be of interest to many of you:

Q. What magazines are available?
A. *WAP Journal*, *A+*, *AppleWorks Journal*, *Byte*, *CALL Apple*, *InCider*, *Open-Apple*, *Nibble*. (After *WAP Journal* *Open-Apple* was the unanimous favorite.)"

Washington Apple PI Journal
Washington D.C., January, 1988, page 10

Open-Apple

POB 7651, Overland Park, KS 66207

Try two months free!

Offer good one time only. Try **Open-Apple** at our expense. Cut out or photocopy this coupon and mail it to us for a free two-month trial subscription.

Ad code: MA82

Free airmail worldwide.

The complete
Apple II
**STATISTICAL
PACKAGE**
for only:

\$99

APP-STAT™

A Powerful Tool for Data Analysis and Forecasting

- Easy to use, no commands to memorize (menu-driven)
- Descriptive Statistics, t-tests (independent and dependent samples), General ANOVA/ANCOVA (up to five factors, **unlimited number of cases**, Repeated Measures, unbalanced designs, contrasts, adjusted means, and more), Correlations, Multiple Regression (up to 15 predictors, **unlimited number of cases**), Crosstabulation, Significance Tests, 10 Nonparametric Statistics, and more
- User defined (multiple) conditional selection of subsets of cases, various ways of treating missing data
- Flexible Data Editor, easy entering/editing of data, complex (conditional) transformations of variables, and more
- Can also access files created by spreadsheets (e.g. AppleWorks) and data bases
- Barcharts, Scatterplots, clear comprehensive output
- Will run on APPLE IIc, IIe and IIGS

To order send check or money order for \$99
(plus \$5 for shipping and handling) to:



StatSoft™



2325 East 13th Street, Tulsa, OK 74104. (918) 583-4149

ASK ABOUT THE VERSION FOR MACINTOSH!

CIRCLE 207 ON READER SERVICE CARD

Get more out of
Print Shop™ and **AppleWorks™**
with these great values.

Labels, Labels, Labels

Use Print Shop™ graphics, borders and fonts to create any size label, badge or postcard. Merge fancy labels with your AppleWorks database. Print in color on color printers. Use new GS multi-color graphics. Retail price \$39.95 for product PS03.

P.L.U.S.

Do you love Print Shop™? We do! That's why we've created P.L.U.S., a set of ten "Print Shop™" related utility programs that are so useful, you'll wonder how you ever got along without them. Retail price is \$39.95 for product PS01.

Big Red Computer Club

An international Apple™II user group with over 8,000 members. Members receive a monthly newsletter called *Scarlett*, a large catalog of public domain software and group discounts on software products. Membership is only \$12.00 a year.

Big Red Computer Club

423 Norfolk Avenue
Norfolk, NE 68701

Phone orders welcome! Call 402-379-4680.

Print Shop is a trademark of Broderbund Software.

**PRINT
COLOR
LABELS**

CIRCLE 113 ON READER SERVICE CARD

**PRODUCT
ROUNDUP**

cabulary of 40 nouns is the basis of six testing and training units: Vocabulary, Categorization, Word Identification by Function, Word Association, Concept-Same, and Concept-Different. Several levels are available, and instructors can control the format and difficulty.

List Price: \$185

Requires: Apple II Plus, IIe, IIc, or IIGs; 64K RAM; one 5¼-inch disk drive; Street Electronics Speech Synthesizer; joystick or Touch Window optional. Copy-protected.

Laureate Learning Systems, Inc.
110 East Spring Street
Winooski, VT 05404
(802) 655-4755

CIRCLE READER SERVICE NO. 510

school, and home. The wallets, available for either 3.5- or 5¼-inch disks, are velcro-sealed. The 3.5-inch size holds 6 diskettes, and the 5¼-inch size holds 15.

List Price: \$11.95-\$16.95
Computer Coverup, Inc.
2230 South Calumet
Chicago, IL 60616
(312) 326-3000
(800) 282-2541

CIRCLE READER SERVICE NO. 512

STATFREE WIPES

Statfree Wipes are disposable, nonresidual cleaning pads moistened with a cleaning agent that includes a static dissipator. The wipes come in a dispenser package containing 20 pads plus an adhesive strip for attaching the package to equipment or furniture.

List Price: \$4.70

Perfect Data Corporation
1825 Surveyor Avenue
Simi Valley, CA 93063
(805) 581-4000

CIRCLE READER SERVICE NO. 513

THE CURTIS CLIP

The Curtis Clip is a copyholder that attaches to the top of either side of a monitor and holds copy at the angle and eye level most comfortable for the user. The clip is beige, is constructed of durable plastic, and uses no metal parts. When not in use, it can be rotated out of the way against the side of the monitor.

List Price: \$6.95

Curtis Manufacturing Company, Inc.
305 Union Street
Peterborough, NH 03458
(603) 924-3821

CIRCLE READER SERVICE NO. 514

FLOPPICLENE

FloppiClene is a cleaning kit for maintaining floppy-disk drives. Available for 3.5- and 5¼-inch formats, the kit consists of disposable cleaning disks, solvent, and a reusable jacket. Refill kits are available.

List Price: \$39.95

Tech-Sa-Port
P.O. Box 5295
Pittsburgh, PA 15206-5295
Written inquiries only

CIRCLE READER SERVICE NO. 515

MISCELLANEOUS

STA-BLK

The STA-BLK reinking printer ribbon is now available in an ImageWriter/Prowriter model. The STA-BLK cartridge contains an ink reservoir and an automatic reinking mechanism that keeps the ribbon from fading. Each ribbon comes with a bottle of refill ink.

List Price: \$39.95

Requires: Apple ImageWriter I or II, or C. Itoh Prowriter or compatible.

Chronos Computers
4186 Sorrento Valley Blvd.
Suite H

San Diego, CA 92121
(619) 455-8200

CIRCLE READER SERVICE NO. 511

DISKETTE WALLETS

Computer Coverup, Inc., has introduced new antistatic nylon diskette wallets.

The wallets, available in five colors, are designed for the organization and safe transportation of disks back and forth from office,

PRODUCT ALL-STARS

Every three months, *A+* will publish summaries of its Product All-Stars—those hardware and software products that *A+* editors and contributors consider exceptional. Watch for this quarterly guide beginning in the June. Here's a list of products that will be covered in detail in the All-Stars guide.

SOFTWARE

ACCOUNTING

Back to Basics
BusinessWorks
BPI Entry Series
Q-Mar General Ledger
Template

DATABASE PROGRAMS

DB Master
ProFILER 3.0
Notes•n•Files

DISK UTILITIES

ProSel
Copy II Plus
Diversi-COPY
MouseFiler
Bag of Tricks 2
Universal File Conversion
Diversi-CACHE

EDUCATION

Touch 'N Write
Great States Race
Car Builder
French Micro Scrabble
Crosscountry USA
Writer's Helper
Show Time
Grammar Examiner
Word Attack
Writer Rabbit
Wordmaze
Number Munchers
Math Blaster Plus
Green Globes and Graphing
Equations
Alien Addition
Quations
Math Rabbit
Fay: That Math Woman
Think Quick
The Enchanted Forest
A.I.: An Experience with
Artificial Intelligence
Crossword Magic
Bank Street Writer III
Homeworker
The Print Shop
Operation: Frog
Information Laboratory
Software—Life Science
Science Toolkit
Dinosaur Dig
The Halley Project: A
Mission in our Solar
System
Oregon Trail
Where in the World Is
Carmen Sandiego?

ENTERTAINMENT

The Zork Trilogy
Suspended
The Wizard and the
Princess
King's Quest I & II
Ultima I, III, IV
Wizardry I-III
The Bard's Tale I & II
Shanghai
Hacker II
Chessmaster 2000
Lords of Conquest
Archon II
Europe Ablaze
Rebel Charge at
Chickamauga
Conflict in Vietnam
Wilderness
Flight Simulator II
The Seven Cities of Gold
Loderunner
Pinball Construction Set
Choplipter!

GRAPHICS

Blazing Paddles
Dazzle Draw
DeluxePaint II
Take 1
Animate
The Graphics Magician
Fontrix
Shape Mechanic and Font
Mechanic
The Graphics Department
Draw Plus
TopDraw
Timeout Graph
Graphic Edge

INTEGRATED

AppleWorks
Foundation

MUSIC

The Music Studio
Instant Music
KidsTime II
Music Construction Set
(for IIGs)
The Music Class
Note-Us
MIDI Music Tutor
Guitar Wizard
Stickybear Music
Peter and the Wolf Music
Foundations of Music: A
Computer-Assisted
Introduction

PERSONAL FINANCE

Quicken
On Balance
Dollars & Sense

TELECOMMUNICATIONS

CommWorks
MouseTalk
Point-to-Point
ProTERM
Talk Is Cheap

WORD PROCESSING

WordPerfect 1.1
Perfect Writer 2.0
MultiScribe gs 2.0
Sensible Writer
MouseWrite
Bank Street Writer Plus
HomeWord Plus

HARDWARE

ACCELERATORS

TransWarp

AUDIO/SOUND/SPEECH

Supersonic
Supersonic Digitizer
Phasor
Echo IIb

CLOCKS

TimeMaster H.O.
No-Slot Clock

DIGITIZERS

ThunderScan

DRIVES/CONTROLLERS

Universal Disk Controller
Chinon 800K Drive

HARD-DISK DRIVES

CMS SC20
Sider D2, D4

MEMORY CARDS

RamFactor
RamWorks III
gs-RAM
OctoRAM
RamPak 4gs
Z-Ram Ultra 3
MultiRAM CX
MemorySaver
QCard
MultiRAM RGB

EXPANSION CARDS

SlotBuster II
ProGrappler
Print-It!
Serial Grappler

MODEMS

AppleMate
DataLink
ProModem 300c



Solutions looking for problems.

If finding answers to all your Apple II® questions has been a problem, AppleFest® '88 at Boston's Hynes Convention Center, May 20-22 is the solution. It's the biggest AppleFest ever! With a full schedule of seminars and conferences, the largest collection of Apple II software ever compiled, and more than 200 companies exhibiting products that answer every Apple II question you can think of. Here's what we mean.

Solutions for Everyone

Which Apple® Is the Right One for You?

Lifelines: A Guide to Support Services for Apple Computer Owners

Telecom I: Having Fun (and Staying Sane) Telecommunicating on the //

Telecom II: Tips for Experienced Telecommunicators

New Graphic Capabilities of the Apple //GS

Composing and Performing Music on the Apple //GS

The New Look of Game Software on the Apple //GS

Managing Home Finances on an Apple // Computer

Programming I: Using the //GS Toolbox

Programming II: For Experts Only

Future Tech: CD-ROM, Voice Synthesis, and Optical Technology

Best Home and Educational Software for the Macintosh®

Dozens of New Product Spotlights

Solutions for Educators

Answers to All of Your Questions About the Apple //GS

Desktop Publishing: Classroom Applications

Apple and the Special Needs Student

Apple's Classroom of Tomorrow: A Glimpse into an Ideal World

Three Favorite Programs by Five Classroom Experts

Science Through Simulations

Creative Classroom Applications of AppleWorks®

Critical Non-Technical Skills for Computing Coordinators

Telecommunications Applications for Classroom Teachers

Educational Computing in Japan, Europe and the USSR

Educational Applications of HyperCard®

Educational Roundtables in Elementary Math and Language Arts, Science, Social Studies, High School Math and Language Arts, Music, Art, and Foreign Languages

Personal Office Solutions

Launching and Operating the Efficient Home Office

AppleWorks I: Introduction to Features and Techniques

AppleWorks II: Sophisticated Applications

An Impartial Review of Apple // Word Processors

The Great Apple // Data Base Showdown

Desktop Publishing Applications

Desktop Presentations

Putting HyperCard to Work in the Personal Office

Solutions From the Top

Keynote Addresses by Apple Chief Operating Officer Del Yocam; Apple co-founder Steve Wozniak; and Boston Computer Society President Jonathan Rotenberg

Educational Keynotes by Tom Snyder, Chairman, Tom Snyder Productions;

software designer Adeline Naiman; and Apple Classroom of Tomorrow Director Martin Engel

More In-Depth Solutions

The AppleFest Intensive One-Day Workshops: featuring small classes, top workshop leaders, valuable hand-outs, lunch, and admission to full AppleFest Conference and Exhibits

Workshop I: AppleWorks (versions for beginning and advanced users)

Workshop II: AppleWorks for Educators

Workshop III: Desktop Publishing on the //

Money Saving Solutions

Save \$15 or more by pre-registering now (or bring this coupon to the door for a lesser discount).

Make reservations now at AppleFest's Headquarters Hotels for great savings on the regular hotel prices. **Plus:** Give yourself a chance to win a deluxe Weekender Package!

Fly on American Airlines, AppleFest's official carrier, for guaranteed lowest prices to Boston. Call 800-433-1790 and ask for STAR number S-14125.

To pre-register for AppleFest, fill out the coupon, or call

1-800-262-FEST
(617-860-7100 in MA)

PRE-REGISTRATION COUPON

Name _____

Affiliation _____

Address _____

City/State _____ Zip _____

Phone _____

Advance Discount Prices

3-Day Conference ~~\$50~~ \$35

3-Day Exhibits Only ~~\$15~~ \$7.50

Family Package (up to four individuals)

3-Day Conference ~~\$200~~ \$80

3-Day Exhibits Only ~~\$60~~ \$30

AppleFest Workshops (Includes Conference and Exhibits)

I: AppleWorks ~~\$125~~ \$95

II: AppleWorks for Eds. ~~\$125~~ \$95

III: Desktop Publishing ~~\$125~~ \$95

Please circle desired date of workshop: May 19 May 20 May 21

Hotel Reservations (Circle first choice, and indicate number of rooms desired.)

Back Bay Hilton 800-874-0663 Single (\$110) Double (\$130)

Copley Plaza 800-225-7654 Single (\$120) Double (\$140)

Arrival Date: _____ Departure Date: _____

Payment

Conference and/or Exhibits Hotel Both

Check enclosed* Credit Card (circle one): AMEX MC Visa

Credit Card # _____ Exp. date _____

Cardholder's Name _____ Amt. of charge _____

Authorized Signature _____

*Hotel reservations must be guaranteed by one night's deposit. Visa, MC, AMEX, or check payable to the hotel of your choice. Checks for ticket fees payable to Cambridge Marketing, Inc.

Mail this form by April 15 to Cambridge Marketing, Inc., One Forbes Rd., Lexington, MA 02173, or call 1-800-262-FEST. 617-860-7100 in MA.

APPLEFEST '88 BOSTON

AppleFest is an independent trade show, not affiliated with Apple Computer, Inc. AppleFest, Apple, Macintosh, HyperCard, AppleWorks, and the Apple logo are registered trademarks of Apple Computer, Inc.

CIRCLE 212 ON READER SERVICE CARD

TIPS AND TECHNIQUES

Readers share tips for the II

GS COLOR CONTROL

I've been experimenting with the GS color-control soft switches for many, many hours, and I think I've finally mastered them. You can really create some interesting effects with them. The program in figure 1, for example, uses them to scroll rainbow patterns in the background, foreground, or border areas of the screen. Have fun playing with it!

SCOTT CORLEY
GLENVIEW, IL

PRINT-SHOP-COMPANION GOODIES

Print Shop Companion users can take advantage of two interesting features the program's manual fails to mention. First, on the front side of the disk, at the main menu, type STEVEN and then press the Esc key. Thereafter, everything on the screen appears upside down! (In

case you're wondering, Steven is the middle name of programmer Roland Gustafsson.)

On the back side of the Print Shop Companion disk, type Control-6 when you see the message that the back side is not bootable. Doing so starts up a nifty maze game you can play even without a disk-operating system.

JEFFREY SHAPIRO
IRVINE, CA

SUPERPRINT! BONUS

While I was working with my SuperPrint! program, I discovered an interesting "Easter egg." With the Clip Art disk in drive 2 and the program disk in drive 1, while you are at the Clip Art menu, press Tab. Doing so takes you to the program disk, where you will find three additional clip-art files to use. One is the little dinosaur that moves across the screen at the opening credits, the second file contains the faces of the people involved in the production of SuperPrint!, and the third contains two views of the SuperPrint! pelican with a big SP emblazoned across its chest. Enjoy!

DANA MAFIT
EUGENE, OR

Please send your Apple II tips to A+, 950 Tower Lane, 18th Floor, Foster City, CA 94404; ATTN: Tips and Techniques. We pay \$25 for each tip we publish, so be sure to include your name, address, and Social Security number.

```

1 REM Copyright <c> 1987 by Scott Corley
2 REM and Piranha Software
3 REM Scrolling is speed-dependant
4 REM Default scroll speed is for fast mode
6 REM 2nd to last data byte is default scroll speed
10 C=0:FOR B=768 TO 813: READ A:POKE B,A:C=C+A:NEXT
30 READ D: IF C < > D THEN PRINT : PRINT "DATA STATEMENT ERROR!":END
35 HOME : FOR X = 1 TO 23: PRINT "Copyright <c> 1987 Piranha
Software":NEXT
36 PRINT ">>>Switch to fast mode"
37 CALL 768
40 HOME
50 PRINT "1: FOREGROUND SCROLL"
51 PRINT "2: BACKGROUND SCROLL"
52 PRINT "3: BORDER SCROLL"
60 PRINT "4: CHANGE SCROLL RATE"
65 PRINT "5: QUIT"
70 PRINT : INPUT "WHICH <1-4:>";A$:A = VAL (A$): IF A < 1 OR A > 5 GOTO
40
80 ON A GOTO 110,120,130,140,150
110 POKE 771,16: POKE 773,34: POKE 779,240: GOTO 200
120 POKE 771,1: POKE 773,34: POKE 779,15: GOTO 200
130 POKE 771,1: POKE 773,52: POKE 779,15: GOTO 200
140 PRINT : INPUT "SCROLL RATE <1-255:>";A$:A = VAL (A$):IF A<1 OR
A>255 THEN 140
142 POKE 813,A: GOTO 200
150 PRINT : PRINT "TYPE 'CALL 768' TO SCROLL"
152 PRINT : PRINT "HIT SPACEBAR TO STOP"
154 PRINT : PRINT "SEE PROGRAM FOR POKES TO CHANGE SCROLL"
155 PRINT "TYPE (TEXT, BACKGROUND, BORDER)"
156 PRINT : PRINT "COPYRIGHT PIRANHA SOFTWARE 1987": END
200 PRINT : PRINT "PRESS SPACEBAR TO STOP SCROLLING": CALL 768:GOTO 40
500 DATA 169,0,105,16,141,34,192,32,33,3,201,240,176,3,76,2,3
510 DATA 173,0,192,201,160,174,16,192,240,5,176,3,76,0,3,96,162,0
520 DATA 232,236,45,3,176,3,76,35,3,96,128,4328

```

Figure 1: Scott Corley's rainbow scrolling program



MARKETPLACE

THE #1 SHOWCASE FOR PRODUCTS AND SERVICES IN THE APPLE II MARKET

MARKETPLACE CLASSIFICATIONS

HARDWARE 143-145

ADD-ON-BOARDS	143
COMMUNICATIONS	
COMPUTER SYSTEMS	143
DISK DRIVES	143
DISKETTES	143
GENERAL	
MONITORS	
NOISE REDUCTION	
PERIPHERALS	144
PLOTTERS	
POWER PROTECTION	
PRINTERS/PRINTER ACCESSORIES	144
STORAGE DEVICES	145
MEMORY EXPANSION	

SOFTWARE 145-148

ACCOUNTING	
AGRICULTURE	
ASTROLOGY	
BUSINESS	145
COMMUNICATIONS	
DATA MANAGEMENT	
DEVELOPMENT TOOLS	
EDUCATIONAL	145, 146
ENTERTAINMENT/HOBBIES	146
FINANCIAL	146
GENERAL	146
GRAPHICS	147
LEGAL	
MAILING LIST	

SOFTWARE *continued*

MAILING PROGRAMS	147
MANUFACTURING	
MEDICAL/HEALTH	
ONE-OF-A-KIND	147
PERSONAL	147
PROJECT MANAGEMENT	
PUBLIC DOMAIN	147
REAL ESTATE	
RELIGION	
SCIENTIFIC	
STATISTICS	147
TAXES	147
UTILITIES	147, 148
VIDEO TRAINING	
WORD PROCESSING	

MISCELLANEOUS 148

ACCESSORIES/SUPPLIES	148
APPLE III	
BUSINESS OPPORTUNITIES	
COMPATIBLES	
COMPUTER INSURANCE	148
COMPUTER LEASING/RENTAL	
COMPUTER SERVICES	
COMPUTER TRAINING	
DATA CONVERSION	148
PUBLICATIONS/CATALOGUES	
SECURITY	
USED EQUIPMENT	
USER GROUPS	148

Advertising Rates and Information: A+ Magazine Marketplace

A+ Magazine Marketplace is a special economical section for product and service listings. Listings are grouped by category and sold by column inches. Second color option available. Standard Directory Listings are also available for a minimum of 3 issues at \$225 per issue (\$675 total).

For additional information call 212-503-5115

A+ Magazine Classified Advertising Staff
 One Park Avenue, New York, NY 10016
 (212) 503-5115

Advertising Directory

<i>Advertising Director</i>	<i>Sr. Advertising Coordinator</i>
Kathryn J. Cumberlander	Monica Dixon
<i>Sales Manager</i>	<i>Production Manager</i>
Daniel L. Rosensweig	Anne R. Brockinton

Account Managers

Lisa Stick, *National Account Manager*
 (212) 503-5102
 AL, AR, IA, IL, IN, KS, KY, AZ, CO, HI, NM, LA, MI, MN, MO, MS, NB, ND, OH, OK, SC, TN, WI, NV, UT, AK, ID, MT, WA, OR, NY, MA, CT, ME, NH, RI, VT, CA (93000 & UP)

Angela Kiffin, *Jr. Account Manager*
 (212) 503-5150
 NJ, DC, DE, FL, GA, VA, NC, SC, WV, MD, PA, CA (92999 & DOWN) TX, CANADA (OTHER THAN BRITISH COLUMBIA), ALL OVERSEAS CALLS.

A+ MARKETPLACE

THE #1 SHOWCASE FOR PRODUCTS AND SERVICES IN THE APPLE II MARKET

HARDWARE/ADD-ON BOARDS

Megaboard Hard Drive Controller

The only ST506 hard drive interface card for the Apple II. Install ProDOS, DOS 3.3, CPM and UCSD Pascal. Standard ST506 interface works with low-cost PC hard drives up to 64 Megabytes. Freely adjustable partitions for each operating system. Each operating system is bootable and user can switch between op. systems in a keystroke. Fits in slots 1-7. Comes complete with card, software, manual and connector cable. Free technical support & 6 mos warranty.

Megaboard, software, cable, manual \$195.00
Order toll free 1-800-223-9443. Pay by COD or check. Add \$5 ship (COD add \$10) CA residents add 6% tax.

PERLIN Electronics 7394 Calle Real, Goleta CA 93117. Call 805-968-6089 for information.

CIRCLE 551 ON READER SERVICE CARD

Choice Computer Products

P.O. BOX 8432, CEDAR RAPIDS, IA 52408
AUTHORIZED DEALER

Factory Installed/Warranted RAM

RAMWORKS III (256K)	\$157
GS-RAM (256K)	\$157
GS-RAM+ (1 MEG)	\$177
RAMKEEPER	\$134
Z-RAM ULTRA 3 (256K)	\$262
Z-RAM ULTRA 2 (256K)	\$209
Z-RAM ULTRA 1 (256K)	\$157
RAMFACTOR (256K)	\$194
TRANSWARP	\$164
SERIAL PRO	\$104
PARALLEL PRO	\$ 74
PHASOR	\$134
DATALINK	\$164
PC TRANSPORTER (256K)	\$391

For the lowest prices on all **Choice** products Call **319-396-2306** (9am-9pm)
MasterCard, Visa, C.O.D. & P.O.
Prices subject to change.

CIRCLE 552 ON READER SERVICE CARD

DISK DRIVES

RODEO PRODUCTS

Rodeo Apple II Disk Drive	\$129.00
Rodeo Unidisk Drive	\$129.00
Rodeo Extended 80 (64K)	\$ 34.95
Rodeo Cooling Fan	
Kensington Style	\$ 34.95
Rodeo Disk Controller (Dual Port)	\$ 39.95
Rodeo IIgs Meg Board	\$Call
Apple Time II	\$ 59.00
GS Stereo	\$ 49.00

Burke and Associates are vendors to over 2,300 school districts nationwide. We build and sell the finest industrial strength Apple hardware on the market. Call us, we will send your school our products to test and evaluate free of charge.

1-800-354-6655

640 W. PATRIOT BLVD.
RENO, NEVADA 89511

CIRCLE 554 ON READER SERVICE CARD

DISKETTES

FLOPPLESS FLOPPIES APPLE USERS ONLY * SPECIAL *

5.25 Diskettes **9¢**
-double side
-w/purchase of LASER128EX (\$475 + \$15 shipping)

BLK. CLR.
5.25 single side .24 .40
double side .25 .45

Includes Envelopes
Quantity 200 or more
call for lower pricing

Colors: red, green, orange,
yellow, white, burgundy,
blue (lt., med., dark)

3.50 singleside .91
3.50 doubleside .99

NO MINIMUM ORDER
Orders under \$30 add \$5.
Please order disks in multiples
of 10 ea. Shipping \$3/100 disks.
Visa, MC, Money Order.
Checks clear in 10 days.

MIDWESTERN DISKETTE

1301 Clayton Road
Creston, IA 50801
1-515-782-5190

CIRCLE 556 ON
READER SERVICE CARD

COMPUTER SYSTEMS



DISCOUNT SOFTWARE

11 S. Wright Avenue
Fairborn, Ohio 45324

APPLE COMPATIBLE HARDWARE SOFTWARE

Laser 128	\$369.00	Copy II Plus	\$25.95
Laser 128 EX	459.00	California Games	25.95
5 1/4" Disk Drive	95.00	Bank St. Writer Plus	54.00
3 1/2" Disk Drive	179.00	Dac Easy Accounting	49.95
2-Slot Expansion Box	42.95	Print Shop	32.00
Universal Disk Controller	74.95	Timeout Desktools	39.95
Laser 128 Mouse	59.00	Timeout Superfonts	54.95
Laser 128 Cables	16.95	Where In Europe is Carmen	
Laser Tech Ref. Manual	19.95	San Diego	CALL
Laser Carrying Case	54.95	Once Upon A Time	25.95
		Stepping Stones Level I or Ilea	25.95
		Mean 18 Golf (GS)	29.00
		Perfect Score SAT	49.95
		Stickybear Series	ea. 25.95

MEMOREX WORK STATION

20-SS/DD 5 1/4" Disks
With File Box
Holds 50 Disks
Only ... \$12.95

CALL TOLL FREE: 1-800-282-0333

CUSTOMER SERVICE & OHIO RESIDENTS: **1-513-879-9699**

10 a.m.-8 p.m. Monday-Thursday • 10 a.m.-6 p.m. Friday
10 a.m. to 3 p.m. Saturday AD #A + 058

SOFTWARE ONLY - Prepaid orders over \$50 receive free shipping via UPS in continental U.S. Please add \$2 orders under \$50. HARDWARE and all orders requiring shipment via U.S. Post Office are subject to additional freight charges. C.O.D. orders under \$100.00 accepted - add \$5. Charge card orders add \$2 service charge. Ohio residents add 6% sales tax. Personal checks require a three-week waiting period. No waiting when paid by credit card, certified check or money order. All items subject to availability and price change. PLEASE CITE AD NUMBER WHEN ORDERING. ALL RETURNS MUST BE ACCOMPANIED BY AN AUTHORIZATION NUMBER. FOR YOUR PROTECTION WE CHECK FOR CREDIT CARD FRAUD.

CIRCLE 553 ON READER SERVICE CARD

A+ Marketplace . . .

The #1 Showcase For Products and Services in The Apple II Market

A+ Marketplace

Standard directory
listings available
to place your ad
Call (212) 503-5115

DISKETTES

Call for FREE CATALOG! QUALITY COMPUTER SUPPLIES AT BUDGET FRIENDLY PRICES!

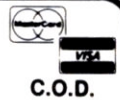

SALE
29¢

MADE IN U.S.A.
5 1/4" DISKETTES



- Sturdy Blank PVC Jacket
- With Write Protect Tabs
- With Envelopes
- In Factory Sealed Poly Packs

SOLD IN LOTS OF 100
DOUBLE SIDE
DOUBLE DENSITY

S&H: \$4.00, FIRST 100 OR FEWER DISKS;
\$3.00, EACH SUCCEEDING 100 OR FEWER.

3 1/2" Diskettes
Unbranded



SALE 99¢ SOLD IN
Ea. LOTS OF 50

New IN STOCK!
3.5" 2 MB
Diskettes! Get
Twice the Storage!
CALL FOR PRICE

Precision Data Products™
P.O. Box 8367, Grand Rapids, MI 49518
(616) 452-3457 • FAX: (616) 452-4914
Michigan 1-800-632-2468
Outside Michigan 1-800-258-0028

MIN. ORDER: \$25.00.
C.O.D. add \$4.00. Cash or
certified check. MI
residents add 4% sales
tax. Prices subject to
change without notice.

CIRCLE 555 ON READER SERVICE CARD

A+ MARKETPLACE

THE #1 SHOWCASE FOR PRODUCTS AND SERVICES IN THE APPLE II MARKET

PERIPHERALS

CANADIAN MAILORDER

DANDAM SOFTWARE

"We specialize in Apple Software & Peripherals"

STAR NX-1000 PRINTER299.00...COLOUR..... 399.00
 DELUXE PAINT II IGS 108.00... COPY II PLUS..... 39.00
 LASER 128 / 128 EX 579 / 669 2 YR. CDN. WARRANTY
 DATA LINK285.00...RAMWORKS BASIC 256K 249.00
 GS-RAM 256K 269.00.....PC TRANSPORTER CALL
 RAMWORKS III 256K 269.00 1 MEG..... CALL
 APPLE II COMPATIBLE DISK DRIVE 5.25"..... 149.00
 SYSTEM SAVER IGS 139.00 TRANSWARP..... 285.00
 MULTISCRIBE 3.0 ...89 / GS...714...ON BALANCE 66.00
 TIMEWORKS - PUBLISH 9.11.....(ON STOCK)..... 94.00
 LASER 3.5" 800K DRIVE 2 YR. CDN. WARRANTY 319.00
 PRICES SUBJECT TO CHANGE WITHOUT NOTICE

Send for free Catalogue
 \$ CANADIAN FUNDS \$

P.O. Box 3374 Tecumseh, Ontario, N8N 3C4 • Canada
 (519) 974-3011 ORDER DESK 1-800-265-9576

CIRCLE 557 ON READER SERVICE CARD

APPLIED ENGINEERING™

Products	256K	512K	1mb	1.5mb
RamWorks III	\$150	\$179	\$236	\$317
ZRamUltra III	\$246	\$276	\$331	—
ZRamUltra II	\$197	\$235	\$285	—
ZRam Ultra I	\$148	\$181	—	—
RamFactor	\$166	\$200	\$264	—
GSRam	\$127	\$155	\$205	\$253

GSRam + 1Meg 2Meg
 3Meg (phone for pricing)

Ramcharger (Battery Backup) \$128
 Transwarp \$170
 Serial Pro \$104
 Timemaster \$ 74
 DataLink Modem \$163
 Viewmaster \$107

PC Transporter (Little Blue)
 384-512K 640K 768K

CHECKMATE TECHNOLOGY:
 ProTerm Communications \$ 70
 Memory Saver \$117

KENSINGTON SYSTEM SAVERS: IGS \$ 72
 CMS Hard Drive Systems CALL

Phone for pricing & Availability
 WE carry the Complete Line Of AE Products
 With Guaranteed Lowest Prices in Country
 ALL Prices Subject to Availability & Change
 w/o notice
 Add \$3 Shipping per order (\$5-Canada)

HI-TECH DISTRIBUTORS
 1227 Cypress
 Richardson, TX 75080
 (214) 458-4411

VI SA • M C

UNIVERSITY & SCHOOL P.O.'s WELCOME!
 CIRCLE 558 ON READER SERVICE CARD

MOUSETRACER

Use your Mac, Iie, or Iic mouse and draw like the pros! Put cartoons, pictures, maps, etc. on the drawing board. Strap your mouse to the Mousetracer and with your favorite graphics program trace the picture of your choice. Works like a 1:1 drafting board pantograph. Send \$34.95 + \$3 UPS shipping. (CA res add \$2.10 sales tax) to:
 BRIMARK INNOVATIONS
 20736 Gale St.
 Canoga Pk., CA 91306

AZ-TECH COMPUTER

Bargains for your APPLE II

(602) 938-1160

14021 N. 51st Avenue
 Glendale, AZ

MasterCard VISA

Prices subject to change. Published prices mail-order only. No surcharges for VISA-MC.
 UPS shipping -\$3/\$100.
 We cannot guarantee machine compatibility.

CIRCLE 559 ON READER SERVICE CARD

World Tour Golf gs	\$35	Timeout Quickspell	\$49
Print Shop e-c	\$35	Memory Saver gs	\$119
Roadwar 2000 gs	\$35	MDI Stereo Card	\$59
Marble Madness	\$29	Publish IT!	\$75
California Games	\$32	AE DataLink 1200	\$179
2400 AD	\$32	ImageBuffer 128K	\$59
ProTERM v2.0	\$79	Deluxe Paint gs	\$69
Timeout Ultramacros	\$59	Graphic Studio	\$49
GS-RAM	\$169	Thexder gs	\$29
RamKeeper	\$149	APPLEWORKS 2.0	\$199
MDI Digitizer	\$49	Super Cooler Fan gs	\$29
APPLE RAM gs 256K	\$129	Gappler c/mac/gs	\$79
Mitsuba 1200 Modem	\$129	Mitsuba 2400	\$229
AE Parallel PRO	\$69	FingerPrint Plus	\$79
PaintWorks Plus gs	\$59	Postcards gs	\$25
WordPerfect 2.0 gs	\$99	VIP Professional gs	\$169
Sea Strike gs	\$35	Cobra Cavern gs	\$35
Mean 18 gs	\$35	Famous Course Disk	\$15
Print Shop gs	\$45	Fantavision gs	\$45
Tower Myra Glen gs	\$39	Sea Strike gs	\$32
Destroyer	\$29	Sub Battle	\$29
Winter Games	\$32	World Games	\$32
Maniac Mansion	\$25	F-15 Strike Eagle	\$29
ASCII Express	\$75	Mouse Talk	\$65
Timeout Sidespread	\$35		

QUALITY AT A DISCOUNT

VIDEO TECHNOLOGIES:	APPLIED ENGINEERING:	PC Transp 2 drives	315
Laser 128	RamFactor 256K	single drive	215
Laser 128EX	512K + +	GS install	\$39
3.5 drive & Controllr	Parallel Pro	GS Ram 256K	155
3.5 drive	32K Buffer \$79, Each	512K + +	Call for Price
Slot Expansion Box	additional 32K add	GM Ram Plus 1Mb	500
FIRST CLASS PERIPHERALS:	Transwarp	2Mb \$925	3Mb 1350
Sider 20Mb hd drive	Ramcharger	RamWorks III 256K	158
Pro-dos only chip	Ramkeeper for GS	512K + +	Call for Price
Sider 40Mb hd drive	Data Link	Z Ram Ultr 2 256K	200
Sider 60Mb Tape Dr	PC Transporter 256K	512K + +	Call for Price
Sider 90Mb hd Drive	384K \$425	KENSINGTON MICRO:	
40Mb hd/60Mb Tape	512K 455	System Saver-II + Iie	65
90Mb hd/60Mb Tape	640K	GS System Saver	69
	CALL	PC Transp keyboard	110

Free illustrated catalog. Pay by check, free shipping. Credit Card & COD + shipping. We honor Discover Card, also accept with 4% surcharge: Amer Exp, Diners & Carte Blanche. NY residents add sales tax.

NORTH FORTY ENTERPRISES LTD.
 P.O. Box 172A, E Meadow, NY 11554 (516) 679-8790 7 Days to 11PM

CIRCLE 560 ON READER SERVICE CARD

CANADIAN COMPUTER OUTLET INC

Apple Compatible

LASER 128

\$576.

Canadian Funds

For orders only call
 COLLECT
 (416) 849-0737
 P.O. BOX 7081
 OAKVILLE, ONTARIO L6J 6J5

For Catalogue
 CIRCLE 561 ON READER SERVICE CARD

PRINTERS/PRINTER ACCESSORIES

SELL US YOUR EMPTY TONER CARTRIDGES \$10

- \$6.50/cartridge • \$3/used fixer cleaner • \$5.00/box-styro
- PRINTERS: HP series 1&2, Apple, Canon QMS, XCR...
- COPIERS: Canon PC models 10, 14, 20 and 25.
- You pay shipping for empties. Ship in orig. box & styro

BUY OUR REFILLED CARTRIDGES

- BLACK: \$40 (\$50 w/o) BLUE/BROWN: \$60 (\$70 w/o)
- We pay shipping • Over 20% more toner than new.
- Quality Control sheet and felt cleaner included.
- first nationwide cartridge refiller... PCIVEEK 12/16/86 p16

MICHLIN COMPUTER CONSULTANTS INC
 LASER CARTRIDGE DIVISION
 3770 Plaza Drive Suite 1
 Ann Arbor, Michigan 48106-7354
 VISA/MC/P.O. welcome
 313-663-3800 TELEX 98-1520
 800-63-TONER FAX: 3136639862
 Ad is photo of recharged cartridge printout

CIRCLE 562 ON READER SERVICE CARD

A+ Marketplace
 For Information
 Call (212) 503-5115

PRINTERS/PRINTER ACCESSORIES

Re-Ink Your Fabric Ribbons!

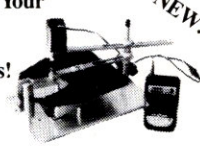

ELECTRIC EZZEE INKER \$89.50

The new **Electric Ezee Inker** is a precision compact machine. It arrives at your home or office fully assembled and ready for use, ink is included. Mount your ribbon on the **Electric Ezee Inker** and "like new" print is just moments away; they're that simple and easy to use. The **Electric Ezee Inker** will work with most ribbons sold on the market today.

Other models available:
Ezee Inker \$39.50/Ink Master \$159.00

Call today for more information
 Toll Free 800-553-2404
 In Iowa 319-987-2976

BORG INDUSTRIES
 525 Main Street
 Janesville, Iowa 50647
 CIRCLE 563 ON READER SERVICE CARD

ATTENTION: LASERWRITER™ OWNERS

Stop throwing away those empty toner cartridges! Call Laser's Edge — We'll recondition your cartridges for **\$55** (Quantity Discounts Available). **100% Guaranteed.** Also available: Color cartridges, legal cassettes, paper output trays, collators, and many other accessories. We offer complete Laserwriter™ rebuilds for **\$249.00** when they exceed the recommended 100,000 print life expectancy. Call:

Laser's Edge
 392 Salem St.
 Wilmington, Ma. 01887
 (617) 658-0178

CIRCLE 564 ON READER SERVICE CARD

A + Marketplace —
 the #1 showcase
 for products and
 services in the
 Apple II market.
 To place your ad call:
(212) 503-5115

A+ MARKETPLACE

THE #1 SHOWCASE FOR PRODUCTS AND SERVICES IN THE APPLE II MARKET

STORAGE DEVICES

WORM
HARD DISK DRIVES
 10 meg . . . \$599
 20 meg . . . \$729
 40 meg . . . \$849

Pro DOS, DOS 3.3, Pascal, CPM capability.
 Worm drives are complete. Nothing extra is needed.
 Send SASE for FREE catalog.

Superior Computing
 1002 Eastview Drive
 Riverton, Wyoming 82501
 307-856-7847

CIRCLE 565 ON READER SERVICE CARD

SOFTWARE

BUSINESS

SMALL BUSINESS TEMPLATES

AppleWorks! Sets up database of clients, customers or prospects. Produces bills, accts. rec., bad debt, work in process, etc. reports, mailings. All automatically. Feeds into a detailed profit and loss for your business. Has macros for use with Super Macro Wrks. Full instructions — \$29.95 MC/VISA/CHK.
 Oasis Software
 627 Monroe
 Buckeye, AZ 85326
 (602) 386-7276

EDUCATIONAL

HELPWORKS

HELPWORKS is a manual combined with diskettes that uses new techniques to show the best way to use AppleWorks short of having an expert instructor at your sides at all times.

- 100's of questions and answers in a data base for quick and easy access.
 - In depth instruction on the Data Base and Spreadsheet that will quickly make you a productive AppleWorks User.
 - Tips, Tricks, and Much more.
- "HELPWORKS" includes something for just about everyone."
 Cynthia Field..inCider

ONLY \$49.95
 (806) 796-8495

Plus \$3.50 shipping and handling—plus cost of shipping & handling outside the continental U.S.

HELPWORKS Software Corp.
 PO Box 2913 Lubbock, TX 79408
 Ask your local dealer for HELP WORK

CIRCLE 566 ON READER SERVICE CARD

EDUCATIONAL

When it comes to learning, we write the software.

SILVER BURDETT & GINN, America's leading publisher of K-8 educational materials, now offers a complete line of learning software for school and home use. To find out more about our math, reading, science and other subject area software, write for a FREE CATALOG:

Silver Burdett & Ginn, Dept. A, 4343 Equity Drive, P.O. Box 2649, Columbus, Ohio 43216.

No risk 30 day trial!

SILVER BURDETT & GINN

CIRCLE 567 ON READER SERVICE CARD

IMAGINE detailed info on 90% of ALL technical & professions US Jobs!

CareerWorks™

Switch Between 277 jobs in Seconds!

CareerWorks™ is a complete OCCUPATIONAL DATABASE for AppleWorks users that contains 22 categories of concise information including: (REQUIRES APPLEWORKS)

- Starting and average monthly earnings
- Minimum and maximum yearly earnings
- Physical demands such as "stamina," "agility"
- Levels of stress associated with a career
- Expected job competition
- Number employed per career
- Job entry requirements, such as "high school diploma needed," "college education required"
- The expected growth rate for the occupation
- Working hours are: "40/week," "irregular"
- Risks, hazards and job-safety factors
- Common KEYWORDS used
- KEYWORD DICTIONARY and more!

Now Only \$49.95 (Six packs \$149 w/manual)

Sextant Software \$35/h
 P. O. Box 694
 Latrobe, PA 15650

CALL NOW 412-537-3500
 VISA/MC OR C.O.D. Mon.-Fri. 8-5 EST

CIRCLE 568 ON READER SERVICE CARD

B+ Determine Grades The Easy Way! D 95 C

Use the **J & S Grade Book, New ProDos version. (5.4)**

This new version of the **J & S Grade Book**, will print grade book pages, progress reports, record incompletes, and average and weight all grades. The built in editor permits easy modification of all data.

New features include the use of a RAM disk for greater speed, enter grades in any order, and design your own progress reports. Up to 55 grades per student

For all Apple II's Only \$49.50. (includes a backup). Grade book demo \$5.00

J & S Software
 135 Haven Avenue
 Port Washington, NY 11050
 (516) 944-9304

CIRCLE 569 ON READER SERVICE CARD

McGUFFY'S GRADER

EDUCATORS CHECK US OUT

- ✓ Spreadsheet Format
- ✓ Weighted Averages
- ✓ Progress Reports
- ✓ 50 Comment File
- ✓ Percents
- ✓ Points
- ✓ Missing Assignment List
- ✓ Roster Duplication
- ✓ Statistics
- ✓ Semester Averaging
- ✓ Record Book Pages
- ✓ Code Numbers
- ✓ Letter Grades
- ✓ Your Own Symbols

SUITABLE FOR ALL LEVELS OF EDUCATION FOR APPLE IIe/C/GS (80 Col., 128K)
 FREE TRIAL IN YOUR SCHOOL FOR 30 DAYS

Only \$49.50 Plus \$2.00 Shipping/Handling

MIDWEST SOFTWARE VISA
 Box 214 Mastercard
 Farmington, Michigan 48332

1-800-422-0095*

*MICHIGAN & ORDERS AFTER 5 P.M. 313/477-0897

CIRCLE 570 ON READER SERVICE CARD

DOING MORE SCHOOL WORK WITH APPLEWORKS IS AS EASY AS 1...2...3!

1. TestWriter In every respect, TestWriter is a quality product. Easy-to-use editing capabilities and careful program design assure that most teachers will be using it within minutes without consulting the manual. You can even load test fields into Apple Writer or AppleWorks to achieve additional word-processing support. Since MicroMedia has a 30-day satisfaction guarantee, you can't go wrong with this one. It is certainly worth a look. — A+ Magazine **NEW!** (Does not require AppleWorks) \$39.95

2. SchoolWorks: Teacher Our best-seller contains 36 ready-to-use application templates to help you with addresses, attendance, grading, inventory, lesson plans, seating charts, and so much more. \$55.00

3. SchoolWorks: Media Center Over 50 ways for school librarians to fall in love with AppleWorks! Catalog Cards, bibliographies, acquisitions, circ stats, etc. Economical, indispensable, and very easy to use. **NEW!** \$55.00

Order any or all of these programs today on no-risk 30-day approval. Add \$3.00 S/H VISA/MC/P.O. Ask for your free copy of our 24-page AppleWorks Accessories catalog.

K-12 MicroMedia Publishing
 6 Arrow Rd, Dept. CC,
 Ramsey, NJ 07446
 (800) 928-0401

CIRCLE 571 ON READER SERVICE CARD

The Quarter Mile

An arcade-style math game for kids of all ages.



Basic arithmetic, fractions, decimals, percents, integers and more.

Extremely fast animation. Vast expandability.

"The wards [students] quickly became 'hooked' on it and it was difficult to get them to stop playing once they started.... The students not only enjoy using it but also are showing growth in areas I've had to reteach several times without success."
 Rachel McCoy, Teacher
 Ca. Youth Authority, Yucaipa, CA

\$45.00 Demo: \$3.00
 For the Apple II+(4K), IIc, IIe and IIgs. Add 5% for s/h. CA residents add 6% sales tax.

Call (800) 332-3638 ext. 101
 In CA (415) 268-0804 ext. 101

Barnum Software
 2201 Broadway, Suite 201A, Oakland, CA 94612

CIRCLE 572 ON READER SERVICE CARD

A+ MARKETPLACE

THE #1 SHOWCASE FOR PRODUCTS AND SERVICES IN THE APPLE II MARKET

EDUCATIONAL

Interactive Biology Software

Your students are in control with the unique and enjoyable Bio-Soft Probe Series. Using a simulated probe with detailed graphics, students investigate biological structure and function; review with the Name Game; take the scored test. Apple compatible. Teacher tested and approved, enthusiastic response from students. Demo disk and catalog, \$4.

BioSoft, Inc.

P.O. Box 7294 • Winter Haven, FL 33880
(813) 299-8421

CIRCLE 573 ON READER SERVICE CARD

MATH TEACHERS TOOL KIT

The Ultimate Math Worksheet Generator

- Never run out of unique math problems
- Select from variety of problem parameters and page formats
- Adjust to any grade level
- Each set includes concepts, operations and problem solving.

\$40.00 per disks —
\$100.00 per set of three

Micromatics, Inc.
P.O. Box 28211
Baltimore, MD 21234
(301) 529-0541

CIRCLE 574 ON READER SERVICE CARD

IMPROVE YOUR TEST SCORES

Quickly raise test scores & get better grades easily with STUDYMATE. For students, lawyers, doctors, anyone who wants to do well on tests. Perfect for foreign languages, SATs, English, science, professional licensing exams, etc. STUDYMATE tests you on your own material & retests you on questions missed — \$24.95. Add'l. disk w/vocab for S.A.T. exam \$10 more. JACKSON SOFTWARE
P.O. Box 9101 - Dept. AA
Winnetka, IL 60093
800-247-8080 Visa/MC/Check

KINDERCARD

Kindergarten Report Card Software
Use your Apple IIe to create Report Cards & Progress Reports designed for younger students & Resource students. Track Attendance, Performance, and Citizenship using your Goals & Objectives. Quarter, Year-to-date reports, Class & Objective summaries. Easy to use. Inexpensive—\$65.00 (incl. s/h).
CYGNUS EDUCATIONAL APPLICATIONS, INC.
P.O. Box 1277
Sandy, Utah 84091
(801) 566-5520

ENTERTAINMENT/ HOBBIES



**WIN
LOTTO
MILLIONS!**

NEW! Lotto Picker Plus v2.0 stores winning Lotto & Pick 3/4 numbers & uses various statistical analysis to select your possible million \$\$ ticket! BONUS #'s easily handled. Works for all lotteries! For 64k Apple II **\$34.95** (+ 4.55 sh). 3.5" add \$10. IBM, C64 avail.

ORDERS 1-800-634-5463 x 293



170 B'dwy, Suite 201A
New York, NY 10038
Info **718-317-1961**
NY must add sales tax.

CIRCLE 575 ON READER SERVICE CARD

BRIDGE GAMES!—APPLES/MAC

NEW!—Tom Throop's Bridge Baron II—Winner of 1st Computer Bridge Tournament. Bid and play over 1 billion deals—\$49.95. Play Bridge with Sheinwold—test your declarer play on 91 deals designed by bridge author Alfred Sheinwold —\$29.95. Play Bridge with Truscott—top expert Dorothy Truscott shows you her secrets of winning declarer play—\$29.95. 5 Weeks to Winning Bridge—learn how to play bridge from Alfred Sheinwold—\$39.95. \$3s&h each.
GREAT GAME PRODUCTS
8804 Chalou Drive
Bethesda, MD 20817
1-800-GAMES-4-U

MIGHT AND MAGIC PLAYERS

The toughest role-playing game ever requires lots of help and I have it. Character editor for \$19.95. Hint book for \$9.95. Monster editor to change monsters or create your own for \$12.95. Construction set to create your own scenarios for \$24.95. Please add \$2.00 s/h per order.
GOSSELIN COMPUTER CONSULTANTS
P. O. Box 1083
Brighton, MI 48116
(313) 229-2453

FAMILY ROOTS™

Huge variety and capacity for your family history. Make pedigree and descendant charts, group sheets, histories, indices, do searches, address labels, much more. Free samples. Satisfaction guaranteed. All Apples PC and more.
\$185 MC/VISA/AMEX.
QUINSEPT, INC.
P. O. Box 216
Lexington, MA 02173
(617) 641-2930 MA
(800) 637-ROOT Nat

WERDNA THE WIMP GETS HELP

Turn the wimp into a he-man with our character editor (\$19.95). Change attributes and spells, position Werdna anywhere in the maze or choose any monsters to accompany Werdna. Also have hint book (\$9.95) including maps of each level. Please add \$2.00 shipping and handling per order.
Gosselin Computer Consultants
P. O. Box 1083
Brighton, MI 48116
(313) 229-2453

FINANCIAL

UNPROTECTED SOFTWARE

STOCK MARKET STRATEGY 49.95
-Portfolio Strategy
How many shares to buy or sell
-Tracker Strategy
When to buy or sell
-Stock Selector
Best choice from daily listing
DEMO DISK 10.00
-Refundable on purchase of 49.95
NYSE or TSE DATA DISK 15.95
-52 weeks of data
LOTTERY BREAKER 29.95
-Canadian Lotteries, plus 4 digit
HORSE SENSE 29.95
-All track handicapper
DEALER BUSTER 29.95
-Blackjack Tutor, 4 decks, 5 options
US\$ CK or MO to:
KEENTECH SOFTWARE
P. O. Box 353, Station T
Calgary T2H 2G9
Alberta, Canada
Telephone 403-259-5676

GENERAL

APPLE® II GUIDE

to 11,000
software titles*

Available from MENU®, this guide lists the title, vendor name, retail price, system requirements and brief description of each program..... JUST \$14.95

1-800-THE-MENU

* includes APPLEIIGS

CIRCLE 576 ON READER SERVICE CARD

PRODUCT CATEGORIES

HARDWARE

ADD-ON-BOARDS
COMMUNICATIONS
COMPUTER SYSTEMS
DISK DRIVES
DISKETTES
GENERAL
MONITORS
NOISE REDUCTION
PERIPHERALS
PLOTTERS
POWER PROTECTION
PRINTERS/PRINTER
ACCESSORIES
STORAGE DEVICES
MEMORY EXPANSION

SOFTWARE

ACCOUNTING
AGRICULTURE
ASTROLOGY
BUSINESS
COMMUNICATIONS
DATA MANAGEMENT
DEVELOPMENT TOOLS
EDUCATIONAL
ENTERTAINMENT/HOBBIES
FINANCIAL
GENERAL
GRAPHICS
LEGAL
MAILING LIST
MAILING PROGRAMS
MANUFACTURING
MEDICAL/HEALTH
ONE-OF-A-KIND
PERSONAL
PROJECT MANAGEMENT
PUBLIC DOMAIN
REAL ESTATE
RELIGION
SCIENTIFIC
STATISTICS
TAXES
UTILITIES
VIDEO TRAINING
WORD PROCESSING

MISCELLANEOUS

ACCESSORIES/SUPPLIES
APPLE III
BUSINESS OPPORTUNITIES
COMPATIBLES
COMPUTER INSURANCE
COMPUTER LEASING/RENTAL
COMPUTER SERVICES
COMPUTER TRAINING
DATA CONVERSION
PUBLICATIONS/CATALOGUES
SECURITY
USED EQUIPMENT
USER GROUPS

A + Marketplace —
the #1 showcase for products and
services in the Apple II market.

A+ MARKETPLACE

THE #1 SHOWCASE FOR PRODUCTS AND SERVICES IN THE APPLE II MARKET

GRAPHICS

Desktop Publishers, Teachers, Students, Artists & Programmers: Professional Art Library for the Apple IIgs



One of the most complete & useful collections for the IIgs. 16 disks, 100+ images on each. Full screen, full color paintings to carefully crafted line drawings. All styles.

DataSolve 160 Delaware Ave. Freeport, NY 11520 \$29.95 ea. (10+, \$24.95 ea.) 516-868-3066

- Symbols & Signs
- Office & Business
- Borders & Patterns
- Display Words & Fonts
- Computers & Systems
- Travel & Sights
- Holiday & Occasion
- Sports & Activities
- Grownups & Kids
- Zoo, Farm & Pet
- Birds & Butterflies
- Flowers & Trees
- Land, Sea, & Sky
- Around the House
- School Subjects
- Maps & Flags

Each category on 3.5" disk, standard Apple graphics format for maximum compatibility with all IIgs paint programs & most graphic word processors.

CIRCLE 577 ON READER SERVICE CARD

MAILING PROGRAMS

LABEL WORKS Ver. 2.0

Label with color & style!

Now make impressive labels fast and easy! Print in color, boldface, headline, and underline fonts. Merge Appleworks™ database files into labels! Make any size label up to 3" x 7". Separates text up to 5 columns that will justify left, center, or right. Saves and retrieves formats, catalogs ProDOS disks, and Border wrap-around. Learn quickly with program prompting, help screens, and instructions on disk. Requires Apple IIe-IIgs and printer.

Only \$20 (Calif. residents add sales tax)

COMPATIBLE SOFTWARE

P.O. BOX 15181 • FRESNO, CA 93702
(209) 233-7004

CIRCLE 578 ON READER SERVICE CARD

ONE-OF-A-KIND



DESIGN NEEDLECRAFT CHARTS

for Counted Cross-Stitch, Needlepoint, Latch Hook, Knitting, etc. using a revolutionary new computer program—*The Stitch Grapher*. Graphs up to 240 X 400 counts with up to 30 symbols may be generated and printed with any of 3 grid styles along with a color chart. A unique windowing feature allows the artist to move, copy, rotate, mirror image, save and re-use previous designs.

The Stitch Grapher is compatible with the 64K Apple II series computers. Disk plus 90-page manual—\$89.95. For complete information contact: **COMPUCRAFTS**, RFD2 Box 216, Lincoln, MA 01773 or call (617) 259-0409.

Supports the Imagewriter and Scribe printers directly (depicted grid style is available for these printers only). Other dot matrix printers require special interface card or special software.

CIRCLE 579 ON READER SERVICE CARD

ONE-OF-A-KIND

INCREDIBLE APPLE SOFTWARE

Get a Word Processor, Spreadsheet, Database, Money Manager, 5 arcade games plus our 3000 + program catalog disk for **ONLY \$10.00** + shipping/handling.

ORDER TODAY

800-992-1992 (National)

800-992-1993 (Ca only)

619-942-9998 (Foreign)

VISA, MC, AMEX (COD +1.90)

International Software Library
511-104 Encinitas Blvd.
Encinitas, Ca. 92024

CIRCLE 580 ON READER SERVICE CARD

RENT SOFTWARE

OVER 2500 APPLE TITLES!

- Nation's largest library
- **SELL & SWAP** software
- 21 Day rental period
- Rent applied to purchase
- 10 to 20% of list price
- \$2.00 shipping charge
- Money-Back Guarantee!!

Black Sun, Inc.
1988 Chestnut Street
Emmaus, PA 18049
(215) 967-3300



BLACK SUN

CIRCLE 581 ON READER SERVICE CARD

A+ Marketplace...

Standard directory listings available
Call (212) 503-5115

PERSONAL

THE L.I.F.E. DIARY

Keep a journal, or learn from experience about stress, exercise, allergy/asthma triggers, personal change projects. Tables and graphs evaluate factors and problem-solving steps, warn you of breakdown, check progress. Enter reminders, file what you learn, print out records/graphs. For II/IGS: 64k & 128k (2 drives req.) versions. SASE for info; \$24.95 for program and 55-page manual. State RAM, # & size of disc drives.

Dick Inglis, Ph.D.

Dept. A1, 325 Newell Street
Walla Walla, WA 99362

PUBLIC DOMAIN

FREE APPLE SOFTWARE

Choose from +1000's of FREE User-Supported software, Public Domain, Shareware & Freeware. Each disk is packed to the brim with the latest reliable software releases. Below is a list of software ready for immediate ordering!

APPLE IIIGS

Desk Accessories: Visi-bell, Picture Saver, CPR, Mouse Text Remover, Setslots & more.

APPLICATIONS

Home accounting & budgeting program

APPLEWORKS

Database for tracking household items

BUSINESS

Stock market & investment program

EDUCATIONAL

Puzzle Generator, Spell the States & more

GRAPHICS

Pictures for Print Shop & Print Master

TELECOMMUNICATIONS

Terminal program that supports Xmodem, ProDOS & other file transfer protocols

GAMES

Fantastic arcade pinball games & more

UTILITIES

Utility to switch between applications

ADVENTURES

Eamon adventure Lair of the Minotaur CATALOG only \$1.50, free if ordering from this add.

Processing & handling fee of only \$3.50 per disk plus \$3.25 shipping charge per order. California residents add appropriate sales tax. Check, money order or cashier check.

TOTAL AMOUNT ENCLOSED \$ _____

NAME _____

ADDRESS _____

CITY _____ STATE _____ ZIP _____

MC, PO BOX 6963, SAN JOSE, CA 95150 (408) 723-3388

CIRCLE 582 ON READER SERVICE CARD

PUBLIC DOMAIN SOFTWARE

CATALOG \$4.00 OR \$5.00 CAT. & DEMO DISK on demo disk specify category: utility, educational, business, games, or what you might be interested in. Free disk with catalog & demo disk order. If you place an order for a min. of 10 disks you get 2 disks free. Brand-name software is also available. VISA and M/C ACCEPTED

PH# 219-563-7650

B & L CONSULTANTS AND SALES

P.O. Box 461

Wabash, IN 46992

STATISTICS

STATISTIX™ ONLY \$99!

A powerful yet incredibly easy-to-use statistical system. Outperforms programs costing much more.

Flexible data management and transformations, mult. regression, ANOVA, most standard parametric and non-parametric tests, p-values, plots, histograms and many others.

SATISFACTION GUARANTEED!

- Apple II + IIe/IIgs - \$99
- PCMS-DOS - \$169
- 5 or more copies; 20% off

NH Analytical Software™
PO Box 13204
Roseville MN 55113
(612) 631-2852

CIRCLE 583 ON READER SERVICE CARD

TAXES

DID YOU HAVE FUN DOING YOUR TAXES THIS YEAR?

Probably not, but with the **TAXMASTER - 1988 Tax Planner**, you can plan ahead and take the worry out of your annual nightmare. All you need is **AppleWorks** and **128K**.

TAXMASTER - 1988 Planner can plan your financial moves before you make them, estimate your tax liabilities, track your tax expenses, alert you to the AMT, Kiddie Tax and Phantom Tax. Test refinancing, stock sales, business purchases and much more!

\$50.00

Order toll-free: 1-800-826-7146

VISA/MC, Mac & IBM versions too. For more information call or write to us for a brochure.

ISLAND COMPUTER SERVICES
3501 E. YACHT DRIVE
LONG BEACH, N.C. 28461
(919) 278-9483

CIRCLE 584 ON READER SERVICE CARD

APPLEWORKS TAX TEMPLATES

Includes over 15 of the most common forms. Comprehensive, but very easy to use. On line help, integrated, fully documented. IRS approved format. Satisfaction guaranteed \$19.95 + \$2 s/h Comes standard on 5.25 in. disk or add \$2 for 3.5 in. disk.

KRONK FINANCIAL SERVICES

Dept. A

7172 Muirfield Lane
Eden Prairie, MN 55346

UTILITIES

PFS FILE USERS

The "BRIDGE" gives you the ability to extract data from PFS FILE™ to either an ASCII, text file or a DIF FILE. Extracted data can be used with word processors, spreadsheets, for conversion to other data bases (Appleworks™), or for transmission to other computers. All APPLE II's. \$59.95.

SMI SYSTEMS, INC.

P.O. Box 1388

Ft. Lauderdale, FL 33302

(305) 486-6115



A+ MARKETPLACE

THE #1 SHOWCASE FOR PRODUCTS AND SERVICES IN THE APPLE II MARKET

UTILITIES

ProFix 2.1/DOS 3.3

ProFix 2.1 is designed to let you use standard DOS 3.3 programs & files on any ProDos device. It lets you use your HD20SC, Profile, UniDisk 3.5, or other ProDos drive for DOS 3.3. You can install 140, 280, 392, or 400K vol. on your drive (mix & match). Profix works w/Apple IIGS, IIe, IIc, II+ w/64K. Retail \$49.95.

NORDIC SOFTWARE, INC.
3939 North 48th
Lincoln, NE 68504
(402) 466-6502

VIDEO TRAINING

Video Training
NEW for your
Apple Computer
and AppleWorks

How to Use Apple \$29
How to Use Appleworks \$39

These "How To" Videos will take you from start to finish — helping you with easy to follow instructions at your own convenience.

Computer Network

211 W. Fiesta #25
Carlsbad, NM 88220

Shipping \$4.00 — Visa — MC

800-621-0937

VHS (505) 885-6023 Beta

CIRCLE 585 ON READER SERVICE CARD

ACCESSORIES/SUPPLIES

COLOR RIBBONS

RED, BLUE, GREEN, BROWN, PURPLE, YELLOW

Ribbons — Price Each	Black	Color
Apple Imagewriter I/II	3.75	4.50
Apple Imagewriter II (4-C)	—	10.00
AppleScribe	—	—
Epson MX80	3.75	4.25
Okidata 182/192	6.50	7.50
Panasonic K-XP 1090	6.75	7.75
Star NX10/NL10	5.00	6.00

COLOR PAPER

BRIGHT COLOR PACK —

200 sheets/50 each color:
Red, Blue, Green, Yellow.
9 1/2 x 11. \$10.90/pack

PASTEL COLOR PACK —

200 sheets/50 each color:
Pink, Yellow, Blue, Ivory.
9 1/2 x 11. \$10.90/pack

Call for S & H charges.

T-SHIRT RIBBONS (HEAT TRANSFER) — Call For Price and Availability.

For ribbons & paper not listed above, call for price & avail. Price & spec. subject to change w/o notice. Min. order \$25.00. Min. S & H \$3.50. Add \$2.25 C.O.D. add'l. IL res. add 6.25% tax. MasterCard/Visa accepted.

RENCO COMPUTER PRINTER SUPPLIES

P.O. Box 475, Manteno, IL 60950 U.S.A.
1-800-522-6922 • (IL) 1-800-356-9981 • 815-468-8081

CIRCLE 587 ON READER SERVICE CARD

RIBBONS

1-800-331-6841

1-513-252-1247 (Ohio)

Over 350 types

Dealer Discounts Available

★ ★ Satisfaction Guaranteed ★ ★

	BLACK	COLORS
APPLE IMAGEWRITER	2.95	3.45
DIABLO HT II M/S	2.95	—
EPSON LX-80/90	3.50	4.35
EPSON MX-FX 80	2.95	3.65
EPSON MX-FX 100	3.95	4.95
IBM PROPRINTER	4.50	—
NEC P1, 2, 6	5.30	—
NEC P3, 7	6.40	—
OKIDATA 82-92	1.25	1.45
OKIDATA 182-192	4.50	5.75
PANASONIC KXP	4.50	5.75

DAYTON COMPUTER SUPPLY

a division of Den-Sys Corp.

1220 Wayne Avenue, Dayton, Ohio 45410

EST. 1979 TERMS MC, VISA, C.O.D.

CIRCLE 588 ON READER SERVICE CARD

COMPUTER INSURANCE



INSURES YOUR COMPUTERS

Full replacement of hardware, media, purchased software. As low as \$39 yearly. Covers fire, theft, power surges, other accidents. Call for information or immediate coverage.

1-800-848-3469

SAFEWARE, The Insurance Agency Inc.
2929 N. High Street, P.O. Box 02211
Columbus, OH 43202

CIRCLE 589 ON READER SERVICE CARD

DATA CONVERSION

APPLEWORKS DATA TRANSFER

For as little as \$59.95 Burke Software will transfer your data base files to AppleWorks, allowing you to utilize all of AppleWorks superior reporting and sorting capabilities without rekeying your data. We specialize in PFS and other popular database transfers. For more info and prices send your specifics to:

BURKE SOFTWARE
P. O. Box 515, Dept. A
Park Ridge, IL 60068
(312) 823-1357

Advertising Rates and Information: A+ Magazine Marketplace

A+ Magazine Marketplace is a special economical section for product and service listings.

Listings are grouped by category and sold by column inches. Second color option available.

Standard Directory Listings are also available for a minimum of 3 issues at \$225 per issue (\$675 total).

MISCELLANEOUS

ACCESSORIES/SUPPLIES

COLORED PAPER

1-800-322-2580

In Michigan (313) 227-9401 Minimum Order \$25.00

1.—BRITETONES™—Clean Edge

Red • Yellow • Green • Hot Pink • Blue • Gold
9 1/2 x 11 Single Color 50 pack \$ 3.95
Prism Pack—25 of each color \$12.95
25 Matching Card Envelopes \$ 1.95

2.—SOFTONES™—Clean Edge

Yellow • Green • Lilac • Pink • Ivory • Blue
9 1/2 x 11 Single Color 50 Pack \$ 3.25
Prism Pack—25 of each color \$10.95
25 Matching Card Envelopes \$ 1.95

3.—CERTIFICATE PAPER—Clean Edge

9 1/2 x 11 Parchment Pack with Gold Metallic Seals
25 Sheets and Seals \$ 4.95

Continuous Labels, File Cards, Post Cards, Classic Laid Stationery, and Software also available.

DEALER INQUIRIES INVITED
Shipping Additional, Visa, Master Card, C.O.D.

The Experts • PO Box 928 • Brighton, MI 48116

CIRCLE 586 ON READER SERVICE CARD

FACTORY FRESH RIBBONS

RIBBON	BLACK	COLOR
Apple Imagewriter I, II	\$2.75	\$3.30
Apple Imagewriter II 4 Color	—	9.50
Epson LX 80/90	3.35	4.25
Epson MX/FX/RX/ 80	2.90	3.50
Epson MX/FX/RX/ 100	3.80	4.95
Okidata 182/192 (RE-INKER)	4.50	—
Panasonic KXP (RE-INKER)	4.25	—
Silver Reed EX-EXP M/S	4.70	6.70
Colors (Blu,Rd,Gr,Pur) M/S Colors (Blu,Rd,Brn) Chk (no delay), Money Order, C.O.D. S/H \$3 (Over \$50 We pay S/H) NY Res. add sales tax. Hundreds more ribbons available.	—	—

***** MONEY BACK GUARANTEE *****

ISLAND COMPUTER SUPPLY

380 FULTON STREET
FARMINGDALE, N. Y. 11735
(516) 293-6818

USER GROUPS

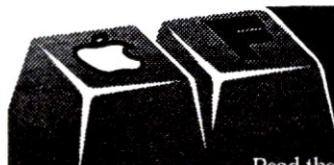

Trying to find the best source of AppleWorks information?

Read the AppleWorks Forum, the largest and most comprehensive monthly AppleWorks newsletter. Only \$24 a year.

National AppleWorks Users Group, Box 87453, Canton, MI 48187. (313) 397-1594

CIRCLE 590 ON READER SERVICE CARD

A+ Marketplace — is a special economical section for product and service listings.

For additional information call:

(212) 503-5115

A+ ADVERTISING INDEX

ALPHABETICAL

READER SERVICE NO. PAGE

A

- 227 Abracadata48
 296 Activision72
 273 Advantage Computing105
 * Applied Engineering..14,
29,47,55,68-69,77,
82-83,99,103,121,123,
125,129,131

B

- * Beagle Bros.....2-3
 326 Berkeley SoftworksCover2-4,1
 244 Bede Tech28
 113 Big Red Apple Club 138
 313 Bose Corporation34
 * Brøderbund Software10,118

C

- 235 CDA Computer Sales151
 300 CMS.....52
 212 Cambridge Marketing140
 107 Central Point Software19
 248 Central Point Software89
 127 Checkmate Technology112
 118 Chinook Technology .31
 322 Claris Corporation39,40-41
 105 Coit Valley Computers18
 192 Compu-Teach33
 136 Computer Cover 113
 265 Computer Direct93
 195 Computer Friends.....66
 312 Computers Plus.....94
 164 Control Data.....58

READER SERVICE NO. PAGE

D

- 340 Davidson & Associates11
 338 Davidson & Associates87
 169 Digital Vision, Inc... 110
 173 Direct Micro38
 310 Diversified Software Research 102

E

- 183 Educational Resources38
 171 Electronic Arts12-13
 103 Electronic Arts 101
 101 Electronic Arts 128
 147 EPYX45

F

- 180 Fast Find..... 130
 149 First Byte Software44

G

- * General Electric Information Services.71
 * Golem Computers... 120

H

- 175 Harcourt Brace & Jovanovich.....42

J

- 167 JDR Microdevices.....78
 308 Jameco Electronics.. 114

K

- 158 Kalglo Electronic.....48
 134 Kensington Microware Cover 6

READER SERVICE NO. PAGE

- 187 Kinson Products Corp.98
 176 Koala Technology 100

L

- 199 Land Tech.....56

M

- 138 Maxima Electronics 102
 152 Memory Plus.....96
 215 Micro Illusions. Cover 5
 250 Milliken Publishing..57

N

- 325 Nexo..... 130
 329 Nikrom..... 137

O

- * Open Apple..... 137
 108 Orange Micro.....5

P

- * Pinpoint Publishing..95
 * Preferred Computing115
 185 Programs Plus.. 132-133
 229 Prometheus Products 16
 190 Public Domain Exchange.....92

Q

- 204 Quality Computers...24
 209 Quality Computers...25

R

- 283 Random House Media51
 202 Ribbon Land76
 109 Roger Coats..... 104

READER SERVICE NO. PAGE

S

- 302 Scholastic Software....37
 200 Sequential Systems....46
 231 Silicon Express..... 124
 222 SoftDisk..... 8
 293 Softsync, Inc.....75
 255 Spectral Graphics Software22
 207 StatSoft 138
 267 Stone Edge Technology64
 155 Styleware17
 122 SubLOGIC 4
 110 SubLOGIC79

T

- 315 TML Systems, Inc61
 217 Teachers Support Software60
 160 Thirdware.....70
 116 Timeworks.....20

U

- 294 USA Micro.....74
 219 UPTIME23

V

- 259 Versacad90

W

- 197 Wolsten's Computer Devices, Inc.60
 120 WordPerfect Corp.....67

Z

- 126 Zimco International ..88
 102 Zip Technology..... 122

A+ ADVERTISING INDEX

BY PRODUCT

PAGE

HARDWARE

DISK DRIVES/STORAGE DEVICES

CMS.....	52
Chinook	31
Kinson Products.....	98
Maxima Electronics	102

INTERFACE CARDS

Applied Engineering	14,
.....	47,55,68-69,77,82-83,
.....	99,121,123,125,129,131
Checkmate Technology ..	112
Orange Micro.....	5
Quality Computers.....	24,25
Sequential Systems.....	46
Zip Technology.....	122

MODEMS

Applied Engineering	29
Prometheus Products.....	16

PRINTERS/PRINTER ACCESSORIES

Bede Tech	28
Maxima Electronics	102
Thirdware.....	70

MISCELLANEOUS

Bose Corporation	34
Central Point Software	19
Control Data.....	58
Digital Vision.....	110
Kalglo Electronics	48
Kensington Microware	Cover 6
Koala Technology	100
Land Tech.....	56

SOFTWARE

BUSINESS

Beagle Bros.....	2-3
Claris Corporation	39-41
Pinpoint Publishing.....	95
Public Domain Exchange..	92

CREATIVITY/PRODUCTIVITY

Abracadata.....	48
Activision	72
Milliken Publishing	57
Softsync, Inc.....	75

DATABASE MANAGEMENT

Stone Edge Technology.....	64
----------------------------	----

DEVELOPMENT SYSTEMS

TML Systems	61
-------------------	----

EDUCATIONAL

Brøderbund Software.....	10
Compu-Teach	33
Davidson & Associates	11,87
First Byte Software	44
Harcourt Brace & Jovanovich.....	42
Scholastic Software.....	37
Teachers Support Software	60

ENTERTAINMENT/STRATEGY

Brøderbund Software.....	118
Electronic Arts.....	101,128
EPYX.....	45
Micro Illusions.....	Cover 5

PAGE

GRAPHICS

Spectral Graphics Software	22
Versacad	90

ON-LINE SERVICES

General Electric Information Services.....	71
--	----

UTILITIES

Central Point Software	89
Fast Find.....	130

WORD PROCESSING SPELLING CHECKERS

Random House Media	51
Styleware	17
WordPerfect Corp.....	67

MISCELLANEOUS

Advantage Computing ..	105
Berkeley Softworks	Cover 2-4,1
Big Red Apple Club.....	138
Diversified Software Research	102
Electronic Arts.....	12-13
Nikrom.....	137
SoftDisk.....	8
Statsoft.....	138
Timeworks.....	20
UPTIME	23

PAGE

ACCESSORIES

DISKS

Direct Micro	38
--------------------	----

MISCELLANEOUS

Computer Cover	113
----------------------	-----

MAIL ORDER

CDA Computer Sales	151
Coit Valley Computers.....	18
Computer Direct	93
Computer Friends.....	66
Computers Plus.....	94
Educational Resources	38
Golem Computers.....	120
JDR Microdevices.....	78
Jameco Electronics	114
Memory Plus.....	96
Nexo.....	130
Preferred Computing.....	115
Programs Plus.....	132-133
Ribbon Land	76
Roger Coats.....	104
Silicon Express.....	124
USA Micro.....	74
Zimco International	88

MISCELLANEOUS

Applied Engineering	103
Cambridge Marketing	140
Open Apple.....	137
Wolsten's Computer Devices, Inc.	60

Apple IIGS 512K Color System

System includes:

- Apple IIGS 256K CPU with Mouse
- Apple Color RGB Analog Monitor
- Apple 3.5 Disk Drive
- Apple 5.25 Disk Drive
- Apple Imagewriter II 220 CPS Printer
- Imagewriter Cable
- Applied Engineering GS-RAM 256K
- Color Rainbow Ribbon for Imagewriter
- Maxell 3.5 Diskettes (Box of 10)
- Maxell 5.25 Diskettes (Box of 10)
- Dust Covers for IIGS & Imagewriter
- Package of Paper (Package of 500)

List Price \$3083 **CDA Price \$2399**

This system includes 512K of RAM required by most Apple IIGS Software and two drive formats for running both Apple II software and new 3.5 format software.

When ordering specify package #8717

Imagewriter II Color Printer Package

Package includes:

- Imagewriter II Color Printer
- Imagewriter Black Ribbon
- Imagewriter Rainbow Ribbon
- Fingerprint Plus Printer Interface
- Printer Interface Cable
- Printer Dust Cover
- Package of Computer Paper

For IIe - CDA Price \$575

For IIc/IIGS - CDA Price \$499

When ordering for the IIe specify package #8711

When ordering for the IIc specify package #8712

When ordering for the IIGS specify package #8713

Above package for the IIc/IIGS does not include or require the Fingerprint Plus printer option.

PC TRANSPORTER

**New! From Applied Engineering
Runs IBM Software!**

	CDA PRICE
PC Transporter 384K	\$395
PC Transporter 768K	495
IIGS Installation Kit & Video	49
IIe Installation Kit & Video	39
Single 360K Drive System	219
Dual 360K Drive System	319
8087-2 Math Co-processor Chip	189
IBM Keyboard	109
IBM DOS 3.3 and Manuals	109

GS Memory Upgrades

Applied Engineering

GS-RAM 256K	\$159
GS-RAM 512K	219
GS-RAM 1 Meg	339
GS-RAM 1.5 Meg	459
GS-RAM Plus 1 Meg	549
GS-RAM Plus 2 Meg	919

AST Research

RamStack Plus 256K	\$109
Ramstack Plus 512K	169
Ramstack Plus 1 Meg	289

MDIdeas

OctoRAM 256K	\$119
OctoRAM 512K	175
OctoRAM 1 Meg	285
OctoRAM 2 Meg	475
OctoRAM 1 Meg*	459
OctoRAM 2 Meg*	829

Orange Micro

RamPak 4GS 512K	\$219
RamPak 4GS 1 Meg	375
RamPak 4GS 2 Meg	839
ChipSet 256K - 150ns	62
ChipSet 256K - 120ns	69

(8 chips used to upgrade memory cards by Apple, Applied, AST, Checkmate and even the Laser 128EX—match speed of chip to existing board)

Apple Hardware and Accessories

Apple Hardware

Apple IIGS	\$ 799
Apple IIe 64K	599
Apple IIe 128K	649
Uni/Duo Disk Controller	49
3.5 Drive Controller	59
5.25 Disk Drive	229
3.5 Disk Drive	319
Unidisk 3.5 (IIe/IIc)	319
Color RGB Anlg Monitor	399
Color Monitor IIe	299
Color Monitor (IIc/IIGS)	299
Monochrome Monitor IIe	109
Mnchrn Monitor (IIc/GS)	109
Imagewriter II w/cable	479
Imagewriter LQ w/cable	1099
Super Serial Card	99
Desktop mouse	72
IIc Mouse	82
IIe Mouse	129

Applied Engineering

Datalink Modem	\$ 179
Ramworks III 256K	169
Ramworks III 512K	229
Ramworks III 1 MEG	349
Colorlink RGB Option	105
RamFactor 256K	199
RamFactor 512K	259
RamFactor 1 Megabyte	379
RamFactor Battery Backup	145
RamFactor Expnrdr 1 Meg	549
Serial Pro	125
Parallel Pro	69
Heavy Duty Pwr Supply	59
Transwarp Accelerator	175

Applied Vision

Future Sound	\$ 179
AST Research	
AST VisionPlus	\$ 259
Bose Inc.	
Roommate II	\$ 229
Casio	
CZ-101 Keyboard	\$ 299
CH Products	
Mach II Joystick-Plat	\$ 32
Mach III Joystick-Plat	39
Flight Stick	52
Checkmate	
Memory Saver	\$ 129
CMS Hard Drives	
Compact Series	
20 Megabyte (85ms)	\$ 749
40 Megabyte (65ms)	1099
Stack Series	
20 Megabyte (65ms)	689
43 Megabyte (40ms)	899

Digital Vision

Computer Eyes II	\$ 109
Computer Eyes IIc	109
Computer Eyes Color IIGS	209
Epic	
2400 Internal	\$ 175
Kensington	
System Saver IIe	\$ 69
System Saver GS	79
Printer Muffler	49
Turbo Mouse ADB	89
MDIdeas	
Supersonic	\$ 49
Digitizer	49

Professional Supersonic

OrangeMicro	
ProGrappler	\$ 75
Imagebuffer 64K	45
Imagebuffer 128K	59
Grappler C/MAC/GS	69
Passport Designs	
Midi Interface with Drum Sync	\$ 99
Midi Interface with Tape & Drum Sync	149
Prometheus	
Promodem 1200 G	\$179
Promodem 1200	249
Promodem 2400 G	289
Promodem 2400	349
SMT	
No Slot Clock	\$ 49
Sony	
RGB Monitor	\$399
RGB Monitor/Remote TV	519
Thirdware	
Fingerprint GSI	\$ 72
Thunderware	
ThunderScan	\$189
Disk Drives	
Hitech IIGS 5.25 (Daisy-chainable)	\$179
American Mitac IIe	125
American Mitac IIc	135
Central Point 3.5 800K	189
Central Point Universal Drive Controller	80

IIGS Software

If you don't see it — call!
— CDA TOP TITLES —

Accolade		Kids Talk	\$ 42
Mean 15	\$ 29	Math Talk	42
HardBall	32	Math Talk-Fraction	42
Activision		Spelling Bee	42
Paintworks Plus	\$ 55	First Letters & Words	42
Music Studio	55	Great Wave	
DrawPlus	55	Kids Time II	\$ 29
Shanghai	32	Learning Company	
Tass Time In	29	Reader Rabbit GS\$	\$ 39
Tone		Microprose	
Activation Bundle:		Silent Service	\$ 39
DrawPlus,		PBI Software	
PaintWorks & Writer's Choice	\$119	Tower of Myrtilen	\$ 42
Champ BasketBall	32	Strategic Conquest	42
Broderbund		Rodger Wagner	
Print Shop IIGS	\$ 42	Softswitch	\$ 99
Data Pak		Notes N Files	99
Graphic Writer	\$ 99	Sierra On Line	
Notes N Files	99	Thunder	\$ 28
Davidson		Space Quest	35
Math Blaster Plus	\$ 35	Styleware	
Electronic Arts		Multiscribe GS	\$ 72
Music		USI	
Construction	\$ 39	Mouse Talk	\$ 69
Deluxe Paint II	70	New Releases	
Instant Music	39	Accolade Graphic Studio	\$ 42
Epyx		Acvision List Manager	55
Destroyer	\$ 32	Styleware Desk Works	42
World Games	32		
Winter Games	32		
First Byte			
First Shapes	\$ 42		

Monthly Specials

Conservor by MDI Ideas—Power control center with surge suppressors and fan. Also organizes your 3.5 drives. **Only \$ 99**

Extended 80 Column Card for Apple IIe, gives your IIe an 80 column display and increases memory to 128K. **Only \$ 39**

CMS 60 Megabyte Hard Drive, 40 ms access time, complete with SCSI interface card, cable and backup software. **Only \$995**

Buy with Confidence

No-Risk 30-Day Satisfaction Guarantee—If you're not 100% satisfied with any Hardware or Accessories purchased from CDA Computer Sales, we will refund the purchase price 100%! (Software excluded.)

Free Technical Support Hotline—We support our customers with knowledgeable technicians trained on all products we sell.

Warranty—On top of the manufacturer's warranty, we offer a 30-day defective exchange policy—if hardware or accessory fails in the first 30 days we will replace that item with a brand new product.

Apple Product—We are not an authorized Apple dealer, therefore during the 90-day warranty period the product must be returned to CDA for warranty repair.

Shipping Charges—UPS Ground Shipping, add 2% (\$3.50 minimum); UPS Blue Service, add 5% (\$5.50 minimum); APO/FPO Shipping, add 4% (\$4.50 minimum); Alaska, Hawaii, Puerto Rico and Canada, add 6% (\$6.50 minimum). Foreign Orders, please call.

Payment—Major Credit Cards Accepted at no additional charge! Cashier Checks and Money Orders shipped promptly; personal checks are held 10 days for clearing. NO COD's please.

Apple is a registered Trademark of Apple Inc.
IBM is a registered Trademark of International Business Machines.

CDA Computer Sales
One CDA Plaza, PO Box 533
Califon, NJ 07830

Monday thru Friday 9 to 9 EST / Saturday 10-5 EST
 Order by Phone, Mail or even over
 Compuserve's Electronic Mall (GO CDA)

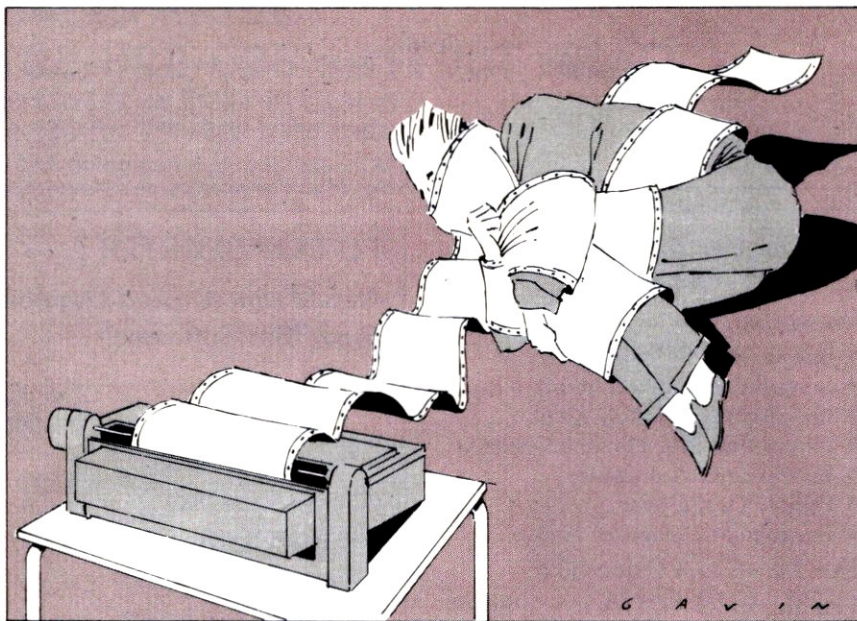

them scratching their heads when the program freezes up.

DAVID L. VIDMAR
BRITT, MN

A. There is no simple PEEK you can perform to check the status of a printer. Since most printer-interface cards can now handle Apple's firmware protocol, however, you can solve your problem by calling a standard status subroutine. Doing so from Applesoft is a bit tricky, but you can do it by calling an assembly-language subroutine like the one in figure 1.

The low-order byte of the status subroutine is stored at location \$C110 in the peripheral-card ROM area (assuming a slot-1 printer). The high-order byte is always \$C1. To see if the printer is ready to accept output, call the subroutine by loading X with \$C1, Y with \$10, and A with 0. When the subroutine ends, the carry flag is clear if the printer is not ready. Before calling the status subroutine, initialize the printer by calling the standard firmware's initialization subroutine (see figure 1).

For more information on the standard firmware protocol, refer to Chapter 11 of my book *Inside the Apple IIe* (Prentice Hall Press, 1985).

RESCUE SQUAD

BY GARY B. LITTLE

PRINTER-ACTIVITY CHECK SUBROUTINE

Q. I'm writing an Applesoft program and would like to know if there is a

simple way to check whether the printer is active. If there is, I'll be able to display a message telling people to turn on the printer instead of having

```

1 *****
2 * To see if printer is busy before sending *
3 * it output, do a CALL 768 from Applesoft. *
4 * If PEEK(0) <> 0, the printer is busy. *
5 *****
6          ORG    $300
7
0300: A9 00  8          LDA    #0
0302: 85 00  9          STA    $00          ;Clear result
10
0304: AD 0D C1 11       LDA    $C10D        ;"Initialize"
offset
0307: 8D 0F 03 12       STA    PATCH1+1
13
030A: A2 C1  14          LDX    #$C1
030C: A0 10  15          LDY    #$10
030E: 20 00 C1 16       PATCH1 JSR    $C100        ;Initialize
17
0311: AD 10 C1 18       LDA    $C110        ;"Status" offset
0314: 8D 1E 03 19       STA    PATCH+1
20
0317: A2 C1  21          LDX    #$C1
0319: A0 10  22          LDY    #$10
031B: A9 00  23          LDA    #0          ;ready for output?
031D: 20 00 C1 24       PATCH JSR    $C100        ;Get status
25
0320: 90 01  26          BCC    BUSY        ;busy if carry
clear
0322: 60  27          RTS
0323: E6 00  28       BUSY INC    $00          ;Non-zero result if
busy
0325: 60  29          RTS

```

Figure 1: A subroutine for checking the status of a printer in slot 1

CLOCK CARD NEEDS ProDOS UPDATE

Q. I have an Apple IIe and a ProDOS-compatible clock card in slot 7. The clock worked flawlessly until January 1 of this year, when the year started coming up as 1982. Can you tell me what's going on?

LARRY WARNEMUENDE
MALI, WEST AFRICA

A. There's nothing wrong with your clock card. The clock driver in older versions of ProDOS is capable of properly handling dates for the years 1982 to 1987 only. The latest version of ProDOS, version 1.4, fixes this problem and gets you to 1988. Your solution, then, is to obtain the latest version of ProDOS from an Apple dealer and transfer it to all your boot disks. +

Gary Little is A+'s editor and author of *Exploring the Apple IIGs*. Please send your questions and problems to "Rescue Squad," A+, 950 Tower Lane, 18th Floor, Foster City, CA 94404.

READER SERVICE CARD

Use this card to get more information about advertised products.



The #1 Apple II Magazine

Void after July 31, 1988

101 102 103 104 105 106 107 108 109 110 111 112 113 114 115 116 117 118 119 120 121 122 123 124 125 126 127 128 129 130
 131 132 133 134 135 136 137 138 139 140 141 142 143 144 145 146 147 148 149 150 151 152 153 154 155 156 157 158 159 160
 161 162 163 164 165 166 167 168 169 170 171 172 173 174 175 176 177 178 179 180 181 182 183 184 185 186 187 188 189 190
 191 192 193 194 195 196 197 198 199 200 201 202 203 204 205 206 207 208 209 210 211 212 213 214 215 216 217 218 219 220
 221 222 223 224 225 226 227 228 229 230 231 232 233 234 235 236 237 238 239 240 241 242 243 244 245 246 247 248 249 250
 251 252 253 254 255 256 257 258 259 260 261 262 263 264 265 266 267 268 269 270 271 272 273 274 275 276 277 278 279 280
 281 282 283 284 285 286 287 288 289 290 291 292 293 294 295 296 297 298 299 300 301 302 303 304 305 306 307 308 309 310
 311 312 313 314 315 316 317 318 319 320 321 322 323 324 325 326 327 328 329 330 331 332 333 334 335 336 337 338 339 340
 341 342 343 344 345 346 347 348 349 350 351 352 353 354 355 356 357 358 359 360 361 362 363 364 365 366 367 368 369 370
 371 372 373 374 375 376 377 378 379 380 381 382 383 384 385 386 387 388 389 390 391 392 393 394 395 396 397 398 399 400
 401 402 403 404 405 406 407 408 409 410 411 412 413 414 415 416 417 418 419 420 421 422 423 424 425 426 427 428 429 430
 431 432 433 434 435 436 437 438 439 440 441 442 443 444 445 446 447 448 449 450 451 452 453 454 455 456 457 458 459 460
 461 462 463 464 465 466 467 468 469 470 471 472 473 474 475 476 477 478 479 480 481 482 483 484 485 486 487 488 489 490
 491 492 493 494 495 496 497 498 499 500 501 502 503 504 505 506 507 508 509 510 511 512 513 514 515 516 517 518 519 520
 521 522 523 524 525 526 527 528 529 530 531 532 533 534 535 536 537 538 539 540 541 542 543 544 545 546 547 548 549 550
 551 552 553 554 555 556 557 558 559 560 561 562 563 564 565 566 567 568 569 570 571 572 573 574 575 576 577 578 579 580
 581 582 583 584 585 586 587 588 589 590 591 592 593 594 595 596 597 598 599 600 601 602 603 604 605 606 607 608 609 610
 611 612 613 614 615 616 617 618 619 620 621 622 623 624 625 626 627 628 629 630 631 632 633 634 635 636 637 638 639 640

Please indicate which of the following microcomputers you currently own and/or plan to buy in the next 6 months.

Please indicate which of the following types of software you plan to buy in the next 3 months.

Your primary job function is:

	(1.) Own	(2.) Plan to Buy
Apple IIGS	A.	F.
Apple IIc	B.	G.
Apple IIe	C.	H.
Laser 128	D.	I.
IBM or clone	E.	J.

	(3) Plan to Buy in 1-3 Months
Productivity Software for Office	K.
Productivity Software for Home	L.
Educational Software	M.
Entertainment Software	N.
Programming/ Language Software	O.

	Check one
Administrative/ General Management	P.
Professional/Technical	Q.
Marketing/Sales	R.
Teaching/Education	S.

PLEASE PRINT CLEARLY—Use only one card per person

Business Phone (_____) _____

Name _____ Home Phone (_____) _____

Company _____ Title _____

Address _____ Apt. _____

City _____ State _____ Zip _____

(Zip code must be included to insure delivery)

Please send me one year (12 issues) of A+ for \$19.97 and bill me. I'll save 44% off the annual single-copy price of \$35.40. (Annual basic subscription price is \$24.97)

A+ 5882

READER SERVICE CARD

Use this card to get more information about advertised products.



The #1 Apple II Magazine

Void after July 31, 1988

101 102 103 104 105 106 107 108 109 110 111 112 113 114 115 116 117 118 119 120 121 122 123 124 125 126 127 128 129 130
 131 132 133 134 135 136 137 138 139 140 141 142 143 144 145 146 147 148 149 150 151 152 153 154 155 156 157 158 159 160
 161 162 163 164 165 166 167 168 169 170 171 172 173 174 175 176 177 178 179 180 181 182 183 184 185 186 187 188 189 190
 191 192 193 194 195 196 197 198 199 200 201 202 203 204 205 206 207 208 209 210 211 212 213 214 215 216 217 218 219 220
 221 222 223 224 225 226 227 228 229 230 231 232 233 234 235 236 237 238 239 240 241 242 243 244 245 246 247 248 249 250
 251 252 253 254 255 256 257 258 259 260 261 262 263 264 265 266 267 268 269 270 271 272 273 274 275 276 277 278 279 280
 281 282 283 284 285 286 287 288 289 290 291 292 293 294 295 296 297 298 299 300 301 302 303 304 305 306 307 308 309 310
 311 312 313 314 315 316 317 318 319 320 321 322 323 324 325 326 327 328 329 330 331 332 333 334 335 336 337 338 339 340
 341 342 343 344 345 346 347 348 349 350 351 352 353 354 355 356 357 358 359 360 361 362 363 364 365 366 367 368 369 370
 371 372 373 374 375 376 377 378 379 380 381 382 383 384 385 386 387 388 389 390 391 392 393 394 395 396 397 398 399 400
 401 402 403 404 405 406 407 408 409 410 411 412 413 414 415 416 417 418 419 420 421 422 423 424 425 426 427 428 429 430
 431 432 433 434 435 436 437 438 439 440 441 442 443 444 445 446 447 448 449 450 451 452 453 454 455 456 457 458 459 460
 461 462 463 464 465 466 467 468 469 470 471 472 473 474 475 476 477 478 479 480 481 482 483 484 485 486 487 488 489 490
 491 492 493 494 495 496 497 498 499 500 501 502 503 504 505 506 507 508 509 510 511 512 513 514 515 516 517 518 519 520
 521 522 523 524 525 526 527 528 529 530 531 532 533 534 535 536 537 538 539 540 541 542 543 544 545 546 547 548 549 550
 551 552 553 554 555 556 557 558 559 560 561 562 563 564 565 566 567 568 569 570 571 572 573 574 575 576 577 578 579 580
 581 582 583 584 585 586 587 588 589 590 591 592 593 594 595 596 597 598 599 600 601 602 603 604 605 606 607 608 609 610
 611 612 613 614 615 616 617 618 619 620 621 622 623 624 625 626 627 628 629 630 631 632 633 634 635 636 637 638 639 640

Please indicate which of the following microcomputers you currently own and/or plan to buy in the next 6 months.

Please indicate which of the following types of software you plan to buy in the next 3 months.

Your primary job function is:

	(1.) Own	(2.) Plan to Buy
Apple IIGS	A.	F.
Apple IIc	B.	G.
Apple IIe	C.	H.
Laser 128	D.	I.
IBM or clone	E.	J.

	(3) Plan to Buy in 1-3 Months
Productivity Software for Office	K.
Productivity Software for Home	L.
Educational Software	M.
Entertainment Software	N.
Programming/ Language Software	O.

	Check one
Administrative/ General Management	P.
Professional/Technical	Q.
Marketing/Sales	R.
Teaching/Education	S.

PLEASE PRINT CLEARLY—Use only one card per person

Business Phone (_____) _____

Name _____ Home Phone (_____) _____

Company _____ Title _____

Address _____ Apt. _____

City _____ State _____ Zip _____

(Zip code must be included to insure delivery)

Please send me one year (12 issues) of A+ for \$19.97 and bill me. I'll save 44% off the annual single-copy price of \$35.40. (Annual basic subscription price is \$24.97)

A+ 5881



NO POSTAGE
NECESSARY
IF MAILED
IN THE
UNITED STATES

BUSINESS REPLY MAIL

FIRST CLASS PERMIT NO. 33854 PHILADELPHIA, PA

POSTAGE WILL BE PAID BY ADDRESSEE



The #1 Apple II Magazine

P.O. Box 40158
Philadelphia, PA 19106-9931

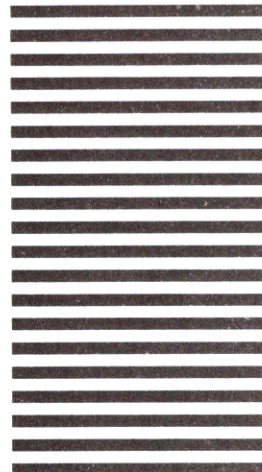

NO POSTAGE
NECESSARY
IF MAILED
IN THE
UNITED STATES

BUSINESS REPLY MAIL

FIRST CLASS PERMIT NO. 33854 PHILADELPHIA, PA

POSTAGE WILL BE PAID BY ADDRESSEE



The #1 Apple II Magazine

P.O. Box 40158
Philadelphia, PA 19106-9931

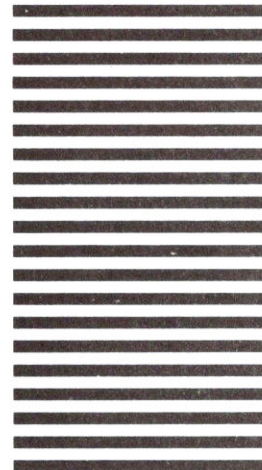

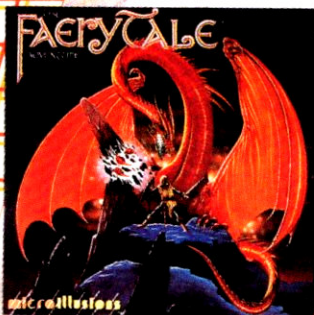

FAERY TALE

Enter a Magical Land where you participate in the adventures of three brothers as they seek their ultimate fate in the Faery Tale Adventure. With over 19,200 playable screens, the quest takes you through a land full of vicious monsters, enchanted princesses, fearsome dragons and even a kindly old woodcutter or two.



Aims for the poor



Julian finds a cave

BlackJack Academy

MICRO-VICE SERIES



BlackJack Academy

Everything you ever wanted to know about the game of BlackJack. For the novice learning, or the pro polishing skills, BlackJack Academy offers both high powered instruction and realistic game play. Develop your skills, and have fun playing BlackJack Academy!

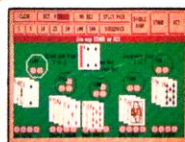

Split hands

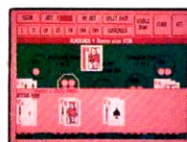

Game in play

FIRE POWER

Fire Power is an action packed arcade style tank battle game that features continuous shoot 'em up excitement! Plot your moves to become king of the hill and capture your opponent's flag while continually fighting off his endless attempts at yours! Features single, double and modem playability!

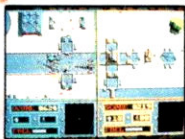

Helicopter patrols add another challenging dimension

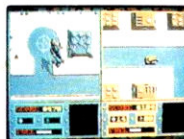

A successful rescue mission nears completion

OTHER PRODUCTS FROM MICROILLUSIONS

• ROMANTIC ENCOUNTERS AT THE DOME™

A true to life Adult experience

• LAND OF LEGENDS™

The ultimate dungeon adventure!

• EBONSTAR™

Hot Arcade style space excitement!

All Microillusions Entertainment and Educational products are developed especially for and are available on Amiga, C64/128, MAC, Apple II GS, and PC/MS DOS Formats.

17408 Chatsworth St., Granada Hills, CA 91344
 Inside CA 818/360-3715 • Outside CA 800/525-215
 CIRCLE 215 ON READER SERVICE CARD

Cool, calm, collected... System Saver® IIgs.



KENSINGTON

System Saver IIgs



AUX



MASTER



Apple IIgs

There are two major threats to the life of every Apple IIgs. And one minor annoyance. The threats? Heat and power impurities. The annoyance? Not enough outlets and too many switches. The solution? System Saver IIgs.

System Saver IIgs keeps your IIgs cool—more quietly and efficiently than Apple's optional internal fan. The bottom of the System Saver IIgs forms a seal with the top of the IIgs case, so its whisper-quiet fan draws air *up and through* the IIgs, instead of just pushing it around inside. It pulls air through the back and bottom vents of the IIgs, over the power supply (the main source of heat), and out the vents in the top at 17 cubic feet per minute.

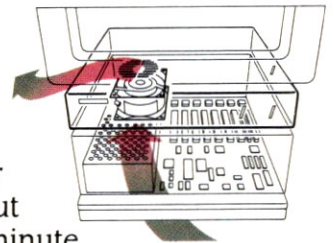

And with nothing to install inside the computer, it won't block two slots like the Apple fan.

System Saver IIgs keeps your IIgs calm. Its surge suppression circuitry* protects your valuable equipment and data from dangerous power surges and spikes. And its noise filter smooths out disruptive EMI and RFI. It makes your whole IIgs system more reliable and longer lasting.

System Saver IIgs keeps your IIgs collected.

It provides four outlets for your computer, monitor, and two peripherals. And it puts everything at your fingertips with two front-mounted switches. (One controls your IIgs and monitor. The other controls your peripherals.)

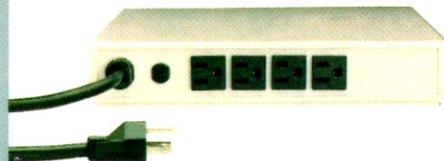

System Saver IIgs, \$99.95, is available at Apple dealers everywhere. For more information, or a dealer near you, call (800) 535-4242. In NY, call (212) 475-5200.

CIRCLE 134 ON READER SERVICE CARD

"Why didn't Apple think of that?"

A+ Magazine

"Editor's Choice"

InCider

KENSINGTON